

Runddusche „Florenz“

93279442-34818506

900x900x1900 mm

D

Aufbauanleitung
Runddusche

I

Istruzioni d'installazione
Doccia circolare

GB

Installation Instruction
Circular Shower

F

Instructions d'installation
Douche courbe

D: Nachdruck, auch auszugsweise, nicht gestattet! GB: Reproduction, even in extracts, is not permitted! F: Toute reproduction de ce mode d'emploi même par extraits est interdite ! IT: È vietata la riproduzione, anche parziale. NL: Nadruk, ook slechts gedeeltelijk, niet toegestaan!

Anleitung, Nr.: 201901131153296121026804

WICHTIG, FÜR SPÄTERE BEZUGNAHME DIESES DOKUMENT
AUFBEWAHREN! SORGFÄLTIG LESEN!

Bestimmungsgemäßer Gebrauch

- Dieser Artikel ist eine vorgefertigte Einheit zum Duschen.
- Dieser Artikel ist nur zum Einsatz im privaten Bereich bestimmt.



Sicherheitshinweise

- Erstickungs- / Verletzungsgefahr! Lassen Sie Kinder nicht mit der Verpackung spielen. Sie könnten an der Folie ersticken oder sich an der Umverpackung verletzen.
- Achten Sie darauf, dass Kinder keine kleinen Teile, wie z. B. Muttern, Abdeckkappen oder Ähnliches in den Mund nehmen. Sie könnten sie verschlucken und daran ersticken.
- Beschädigungsgefahr! Vor der Montage bitte Montageanleitung genauestens durchlesen und Produkt auf evtl. Transportschäden überprüfen. Gehen Sie bei der Montage des Artikels sorgfältig vor.
- Der Artikel darf nur von fachkundigen Personen montiert werden. Es empfiehlt sich die Montage mit zwei Personen durchzuführen.
- Verletzungsgefahr! Beachten Sie bei der Montage, dass einige Teile scharfe Kanten aufweisen.
- Montieren Sie den Artikel nur an einer geeigneten, massiven Wand.
- **Achtung:** Die Befestigung des Möbelstückes an der Wand muss von einer fachkundigen Person vorgenommen werden, da für die Montage an die Wand angepasste Dübel erforderlich sind.
- Stellen Sie sicher, dass sich keine Kabel oder Rohrleitungen in den Bohrbereichen befinden.
- Prüfen Sie die Bereiche vor dem Bohren mit einem Metallsuchgerät.
- Gehen Sie mit den Glasflächen behutsam um! Halten Sie die Glasflächen beim Einbau gut fest, damit sie nicht herunterfallen.
- Dichten Sie die Duschtrennung von außen mit Silikon ab. Benutzen Sie die Dusche erst 24 Stunden nach dem Abdichten.
- Zum Anschluss der Wanne an die hauseigene Wasserentsorgung sollte ein handelsüblicher Syphon mit einem flexiblen Abwasserschlauch verwendet werden.
- Bei Ersatzteilbestellung (siehe Teileliste) bitte an den Kundenservice wenden.
- ESG (Einscheiben-Sicherheitsglas) ist thermisch vorgespanntes Floatglas. Die Vorspannung wird durch eine Wärmebehandlung erreicht und im Falle eines Bruchs entsteht das für ESG typische Bruchbild mit kleinen, meist stumpfen Glaskrümeln. Dadurch wird die Verletzungsgefahr stark minimiert.

Pflegehinweise

Für die Reinigung und Pflege verwenden Sie einen Schwamm oder ein weiches Tuch. Es genügen umweltschonende und sanfte Haushaltsreiniger. Verwenden Sie keinesfalls aggressive oder Lösemittel enthaltende Reinigungsmittel. Benutzen Sie zur Reinigung auf keinen Fall scharfe Gegenstände, Stahlwolle, Chemikalien oder sandhaltige Scheuermittel. Diese führen zu einer Beschädigung der Oberfläche und zu einem Verlust der Garantie. Leichte Kalkbeläge lassen sich mühelos mit etwas Haushaltessig entfernen.

Reinigen Sie die Glasflächen mit einem feuchten Tuch und etwas Glasreiniger und wischen Sie mit einem trockenen Tuch nach.

Benötigte Werkzeuge

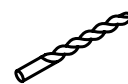
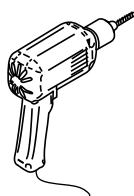
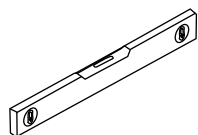
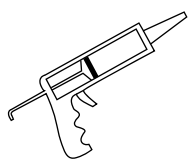

Ø 6mm

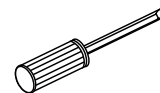



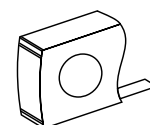
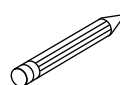
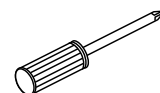











Ø 3.2mm



**Aufgrund des hohen Gewichts dieses Produktes
könnte der Aufbau zwei Personen erfordern.**



Verpackungsinhalt

1x Montageanleitung	➔	
[1] 8x Wanddübel* [2] 8x Schrauben 4x35*	➔	
[3] 2x Wandschienen	➔	 
[4] 8x Schrauben 4x6 [5] 8x Schraubenabdeckungen	➔	
[6] 2x Wasserabweiser	➔	 
[7] 2x Türelemente	➔	
[8] 2x Magnetdichtungen	➔	 
[9] 2x Griffgarnituren	➔	
[10] 2x Schellen	➔	
[11] 1x Aludichtung	➔	 

Montagezeichnung

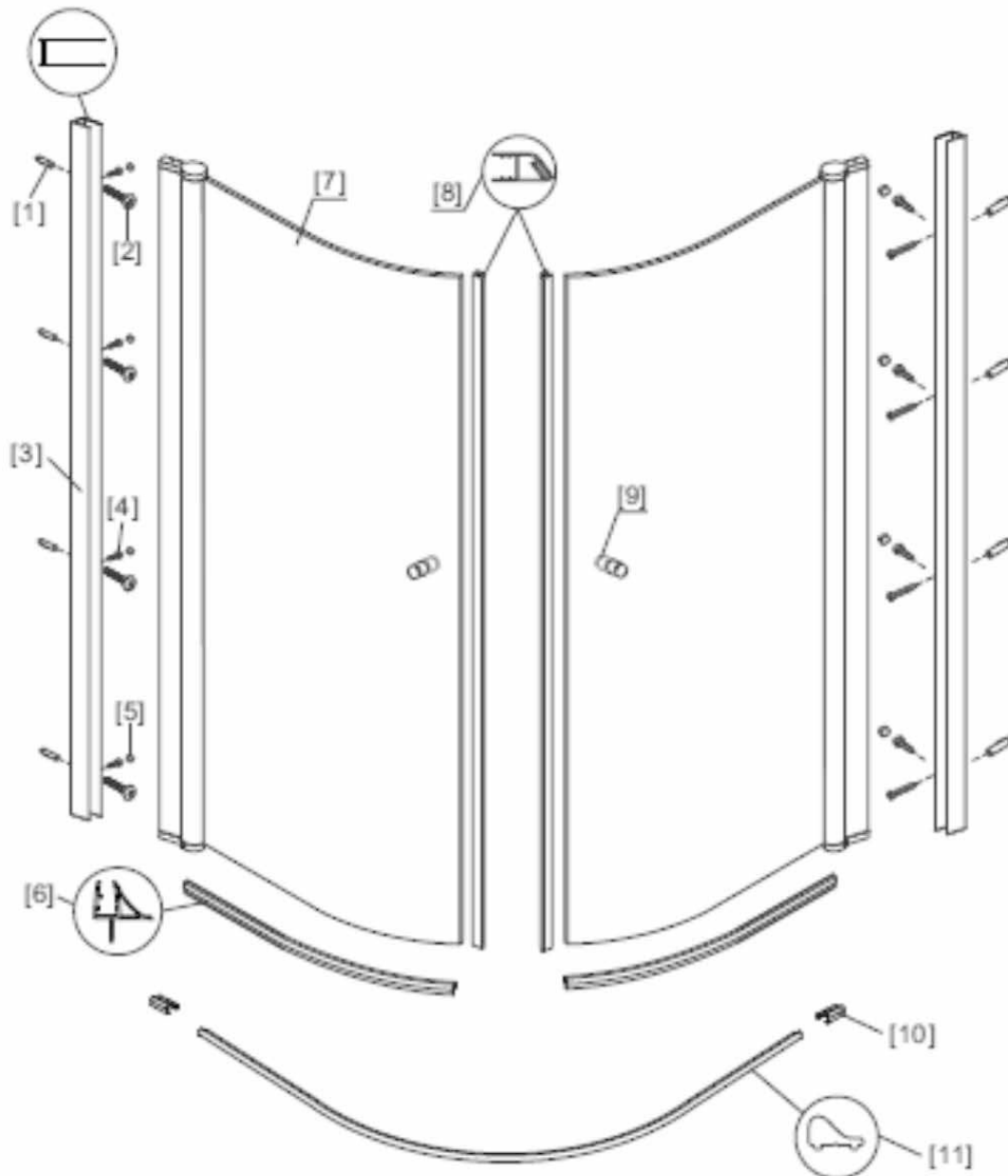

- [1] 8x Wanddübel*
- [2] 8x Schrauben 4x35*
- [3] 2x Wandschienen
- [4] 8x Schrauben 4x6
- [5] 8x Schraubenabdeckungen
- [6] 2x Wasserabweiser

- [7] 2x Türelemente
- [8] 2x Magnetdichtungen
- [9] 2x Griffgarnituren
- [10] 2x Schellen
- [11] 1x Aludichtung

* nicht im Lieferumfang enthalten

AufbausCHRITTE

SCHRITT 1

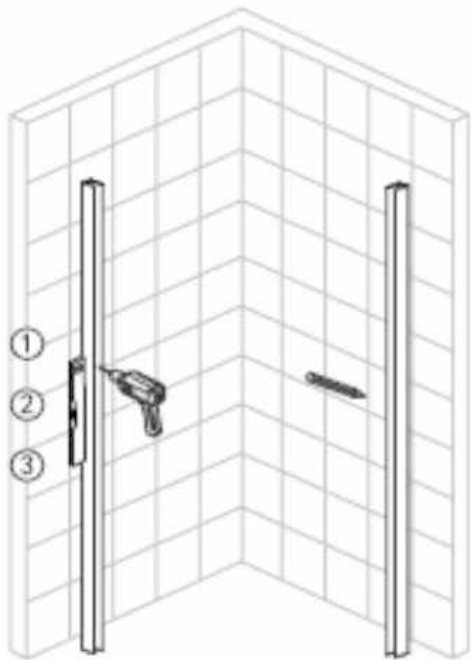

Die Bohrtiefe muss größer sein als die Länge des Dübels.

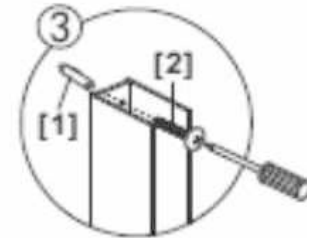
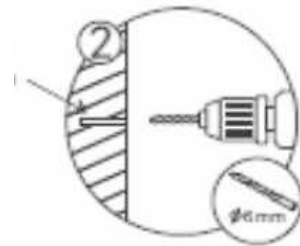
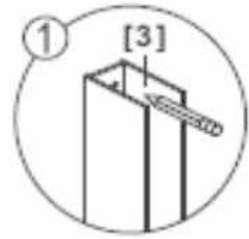

SCHRITT 2

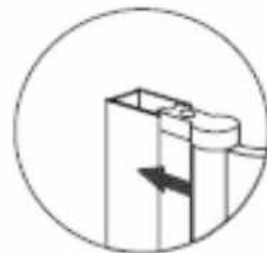
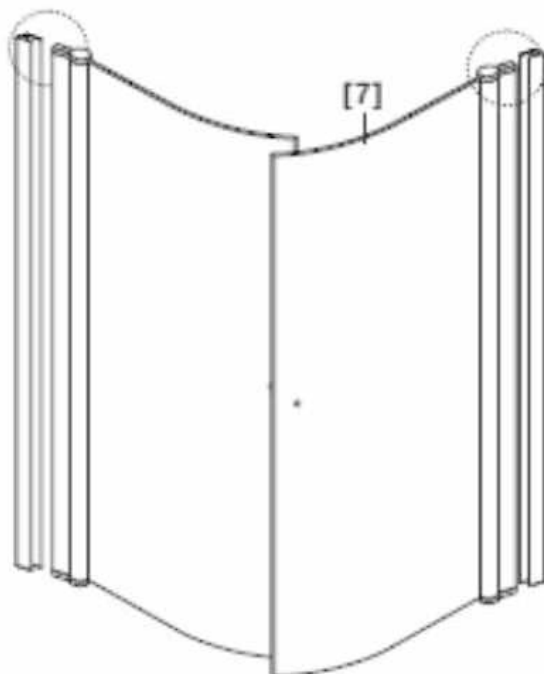

Schritt 3

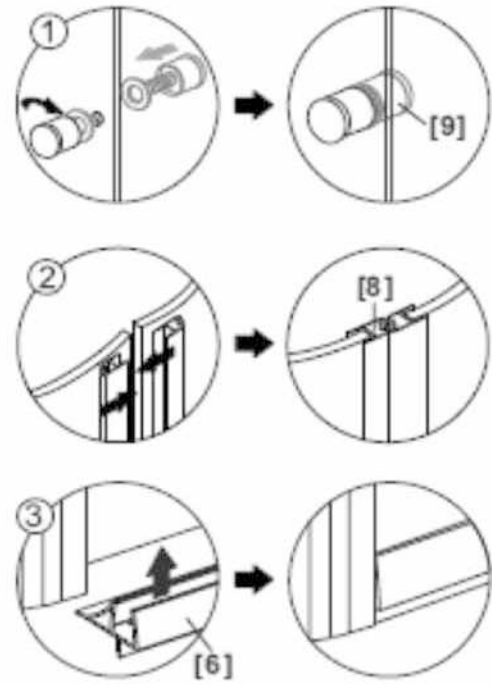
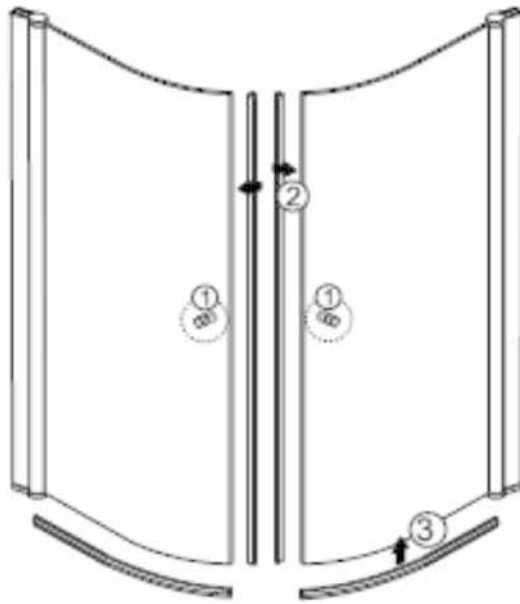

Schritt 4

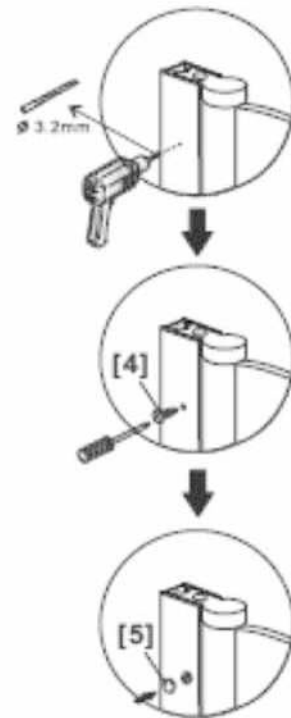
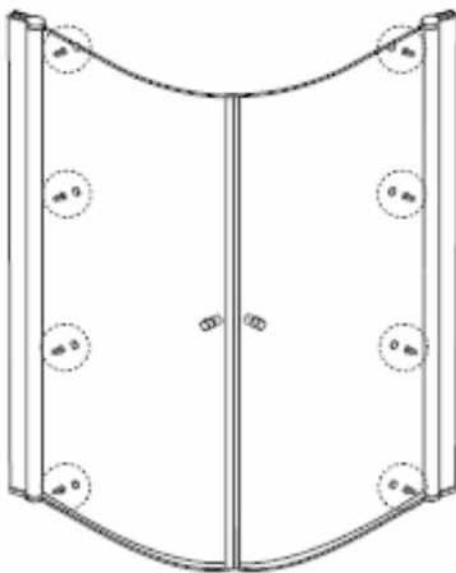

Innenansicht

Schritt 5

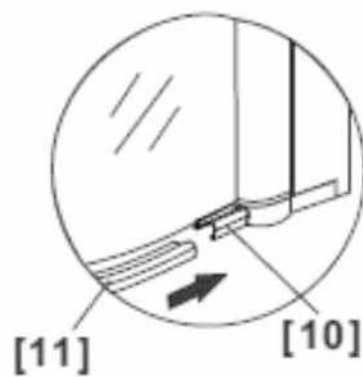
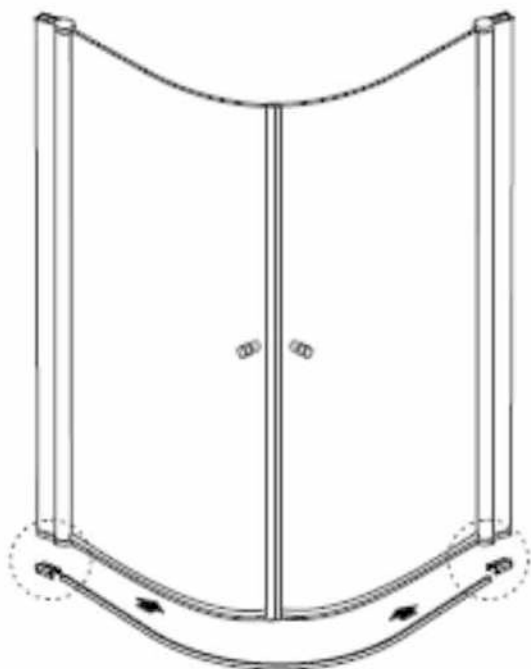

Schritt 6

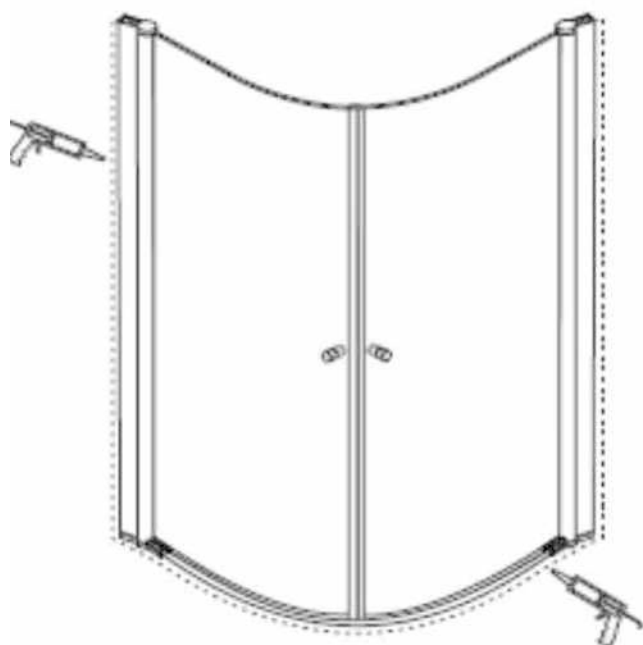



Dichten Sie die das Wandprofil auf beiden
Seiten mit Silikon ab und warten Sie
24 Stunden vor der Erstbenutzung.

Entsorgung

Sollte dieser Artikel einmal nicht mehr benutzt werden können, so ist jeder Verbraucher gesetzlich verpflichtet, Altgeräte getrennt vom Hausmüll zu entsorgen und z.B. bei einer Sammelstelle seiner Gemeinde / Stadtteils abzugeben.

Unser Service

Eine umgehende Fachberatung erhalten Sie von unserem Service-Team:

- **Deutschland:** Telefon 01806-63 06 30, Festnetz 20ct/Anruf, Mobilfunk max. 60 ct/Anruf
- **Österreich,** Universal: Telefon +43 / 662-4485 59, Festnetz je nach Betreiber, Fachberatung
Heimwerken – Otto: +43 / 316-606 159 Festnetz je nach Betreiber, Beratung
Heimwerken – Quelle: +43 / 662-9005 59 Festnetz je nach Betreiber, Fachberatung
Heimwerken
- **Schweiz,** Quelle: **DE:** +41 / 848 85 85 00, **FR:** +41 / 848 85 85 01, **I:** +41 / 848 858 530
- **Ackermann:** **DE:** +41 / 848 85 85 11, **FR:** +41 / 848 85 85 21, **I:** +41 / 848 858 530
- **Niederlande,** call center 0900-1901 (15ct/Min.)

Um Ihnen schnell helfen zu können, nennen Sie uns bitte:

Artikelbezeichnung: Runddusche „Florenz“ 93279442–34818506
und die **Artikelnummer** unter der Sie den Artikel bestellt haben (siehe Rechnung).

Imported by baumarkt direkt GmbH & Co KG, Alter Teichweg 25, D-22081 Hamburg

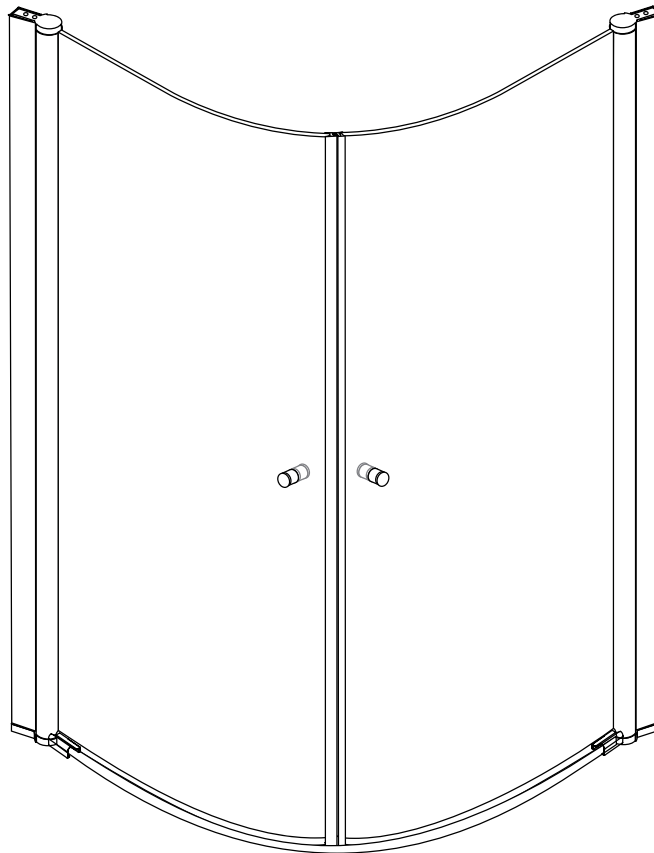

Circular Shower „Florenz“

93279442–34818506

900x900x1900 mm

D

**Aufbauanleitung
Runddusche**

I

**Istruzioni d'installazione
Doccia circolare**

GB

**Installation Instruction
Circular Shower**

F

**Instructions d'installation
Douche courbe**

D: Nachdruck, auch auszugsweise, nicht gestattet! **GB:** Reproduction, even in extracts, is not permitted! **F:** Toute reproduction de ce mode d'emploi même par extraits est interdite ! **IT:** È vietata la riproduzione, anche parziale. **NL:** Nadruk, ook slechts gedeeltelijk, niet toegestaan!

Instruction No. 201901131153296121026804

**IMPORTANT: PLEASE KEEP THIS DOCUMENT FOR LATER REFERENCE!
READ CAREFULLY!**

Indented use

- This product is a prefabricated unit for showering.
- This product is intended for use in private spheres only.



Safety instructions

- Choking hazard / danger of injury! Do not let children play with the packaging. They might suffocate by the wrapping or injure themselves with the packaging cover.
- Make sure that children do not take small parts such as nuts, cover caps or the like into their mouths. They could swallow these and choke on them.
- Risk of damage! Please read the assembly instructions very carefully prior to assembling and check the product for possible transportation damage. Be careful during the product's assembly.
- The product must only be installed by competent persons. The assembly is recommended to be conducted by two people.
- Danger of injury! During the assembly, please consider that some parts have sharp edges.
- Fix product to suitable and solid walls only.
- **Caution:** The wall fixture of the piece of furniture must be carried out by a competent person because it requires customized plugs.
- Make sure that there are no wires or pipelines in the drilling ranges.
- Check the areas with a metal detector prior to drilling.
- Handle the glass components with care! Hold the glass components firmly during installation to not let them drop.
- Seal the shower partition with silicone from the outside. Do not use shower before lapse of 24 hours after sealing.
- To connect the tub with the own in-house water disposal, a commercial siphon with a flexible sewage hose should be used.
- To order spare parts (see part's list), please contact the customer service.
- Tempered safety glass is thermally toughened float glass. The interior of the glass is put into tension through a controlled thermal process. This causes the typical crumbling pattern with small, usually blunt, fragments when the glass breaks, which significantly reduces the risk of injury.

Maintenance instructions

Use a sponge or a soft cloth for cleaning and care. Environmentally friendly and gentle cleaning agents suffice. By no means use any aggressive liquids or cleaning agents containing solvents. Never use sharp objects, steel wool, chemicals or sandy scouring agents for cleaning. These lead to surface damage and loss of warranty. Slight lime deposits are easily removed with some household vinegar.

Clean the glass surfaces with a wet cloth and some glass cleaner and wipe with a dry cloth.

Tools required

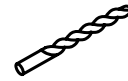
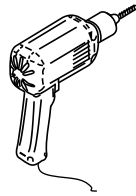
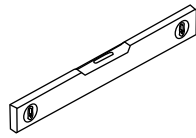
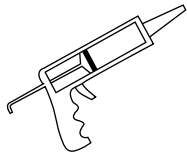

Ø 6mm

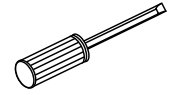



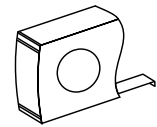
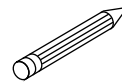
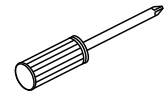



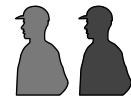

Ø 3.2mm

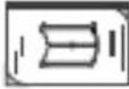

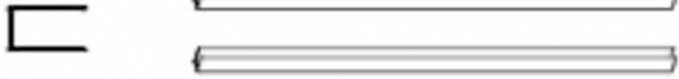
This product is heavy and may require two people to install.

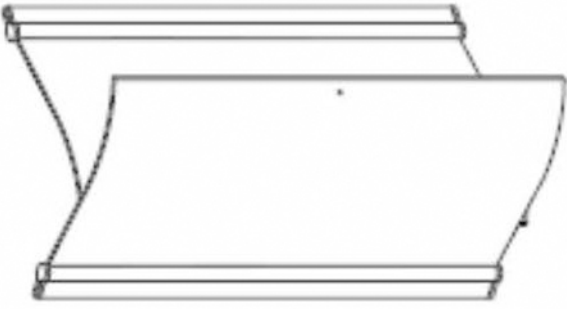

Box contents

1xInstallation Instruction.	➔	
[1] 8xWall Plugs* [2] 8xScrews 4x35*	➔	
[3] 2xWall Posts	➔	
[4] 8xScrews 4x6 [5] 8xScrew Cover Caps	➔	
[6] 2xWater Deflectors	➔	
[7] 2xDoor Panels	➔	
[8] 2xMagnetic Seals	➔	
[9] 2xHandle Sets	➔	
[10] 2xClips	➔	
[11] 1xAluminum Seal	➔	

Assembly drawing

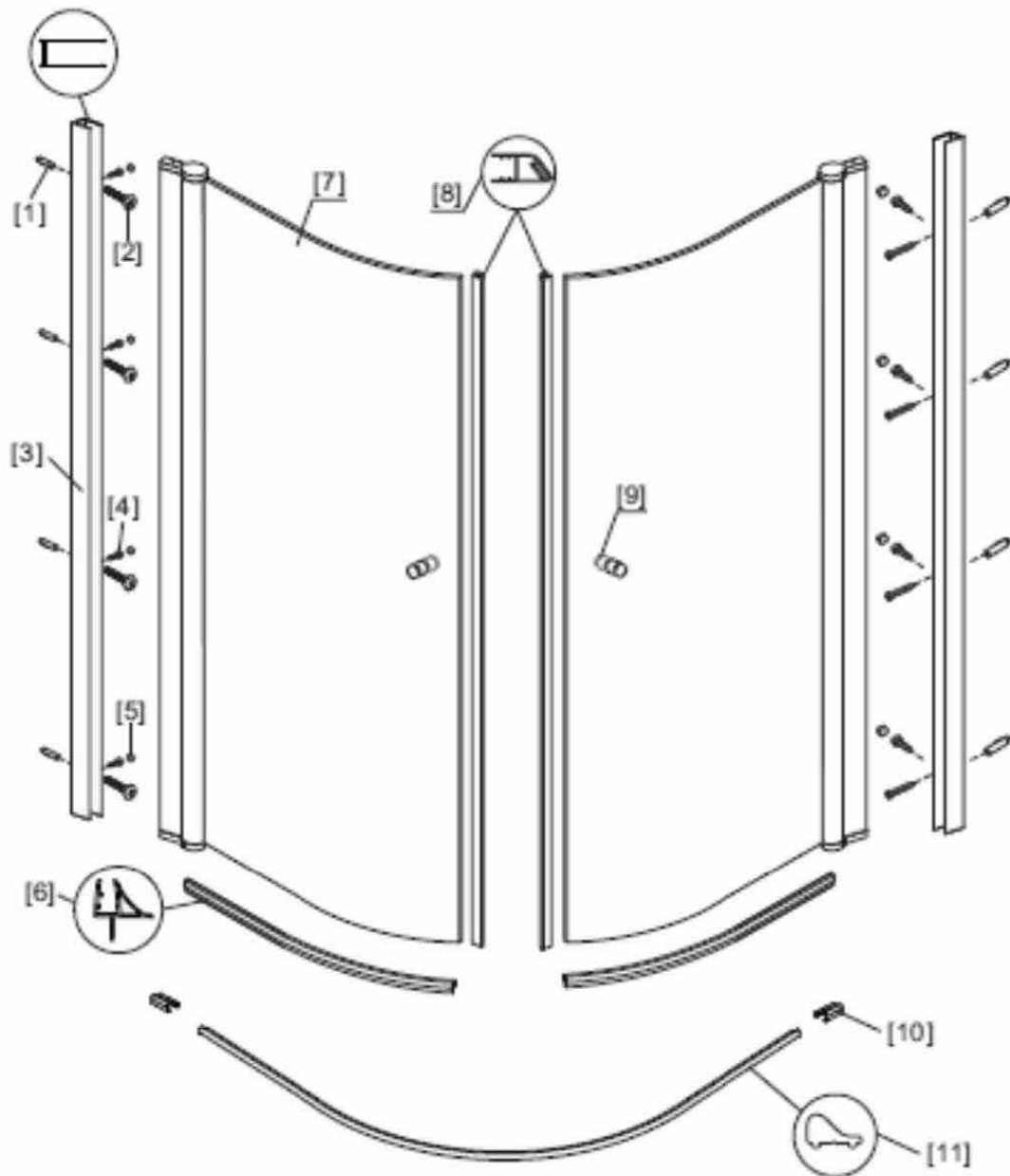

- [1] 8xWall Plugs*
- [2] 8xScrews 4x35*
- [3] 2xWall Posts
- [4] 8xScrews 4x6
- [5] 8xScrew Cover Caps
- * Not include

- [6] 2xWater Deflectors
- [7] 2xDoor Panels
- [8] 2xMagnetic Seals
- [9] 2xHandle Sets
- [10] 2xClips
- [11] 1xAluminum Seal

◆ Installation Steps

Step 1

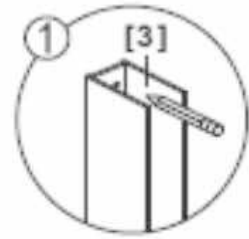
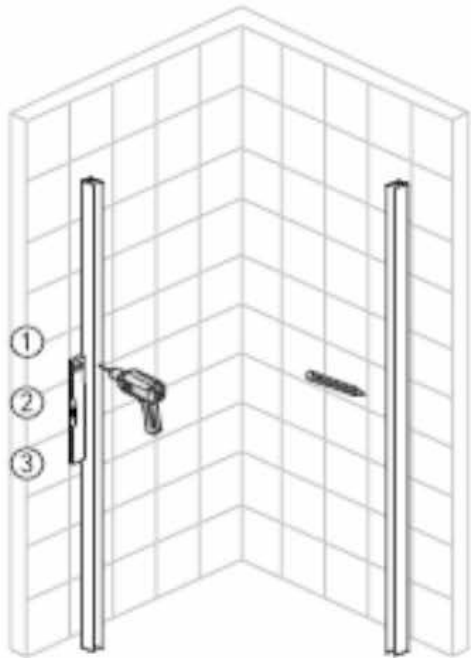

Drilling depth must
be more than the length
of wall plug

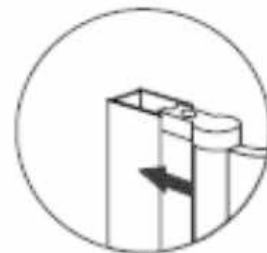
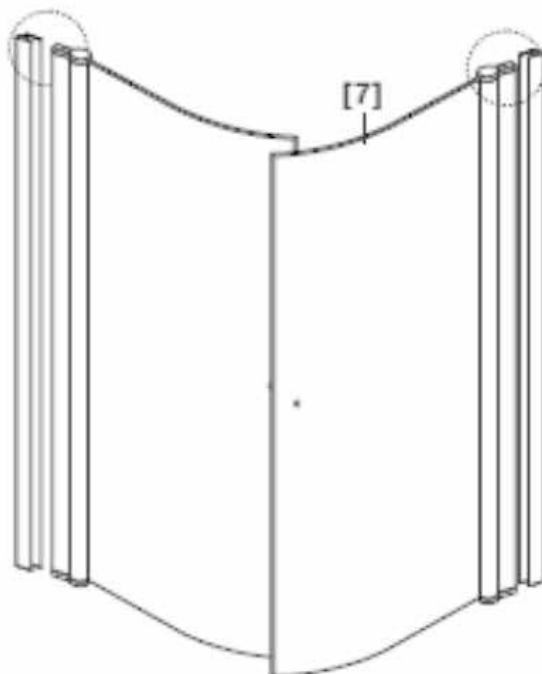
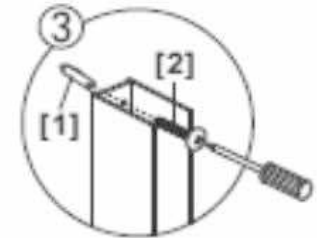
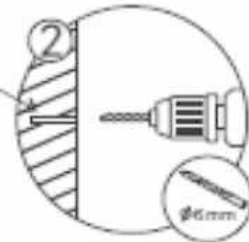

Step 3

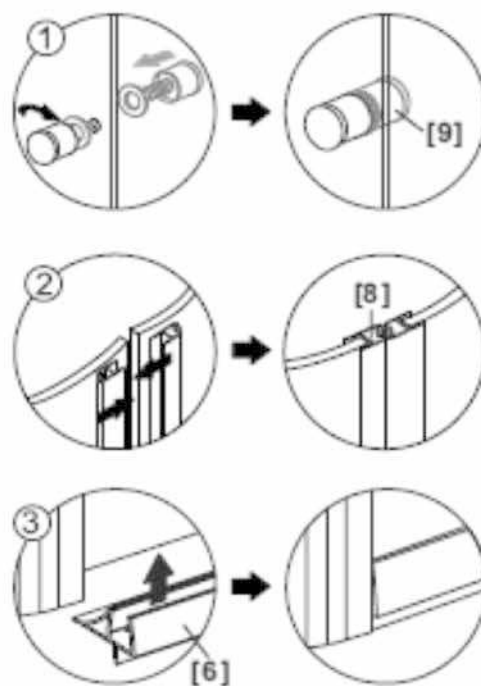
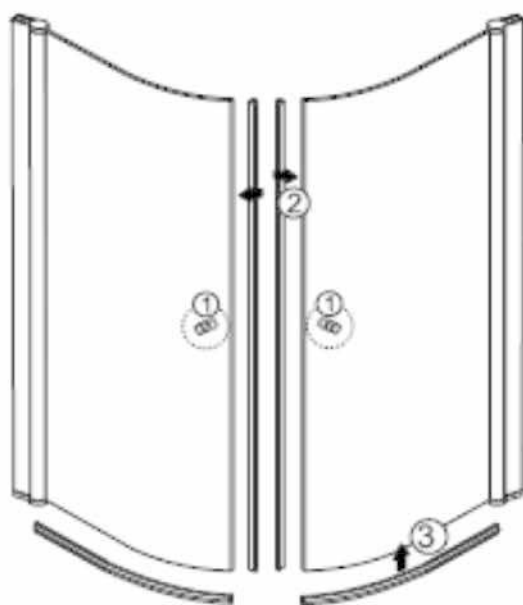

Step 4

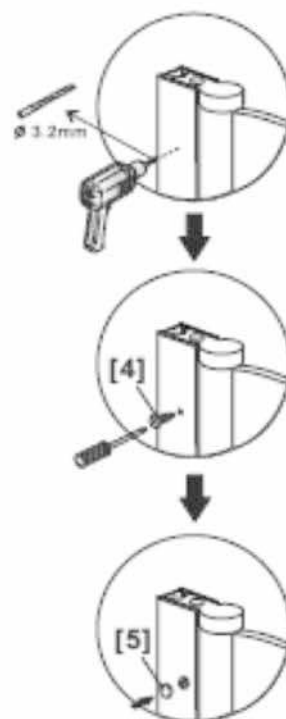
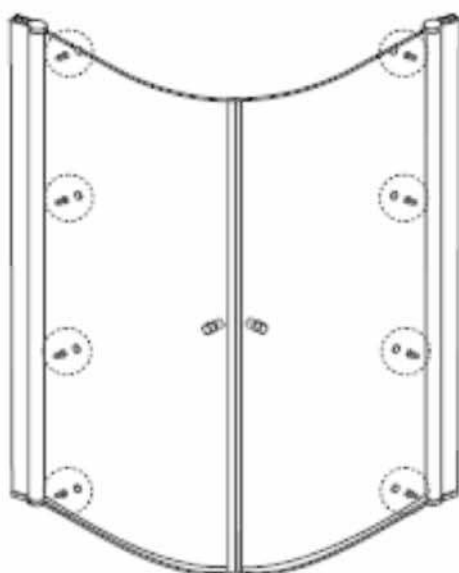

View from inside

Step 5

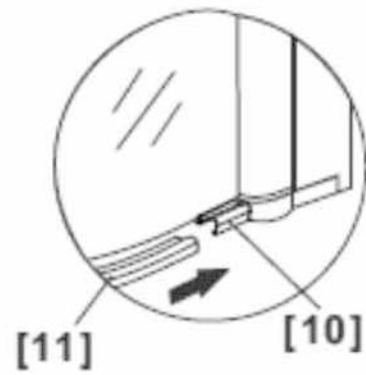
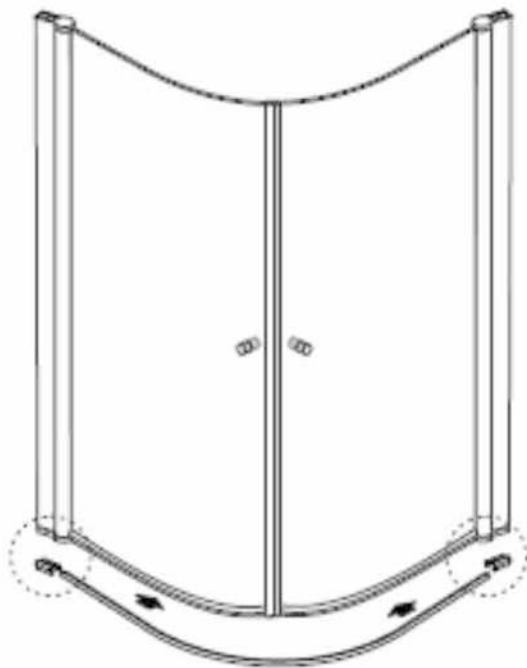

Step 6

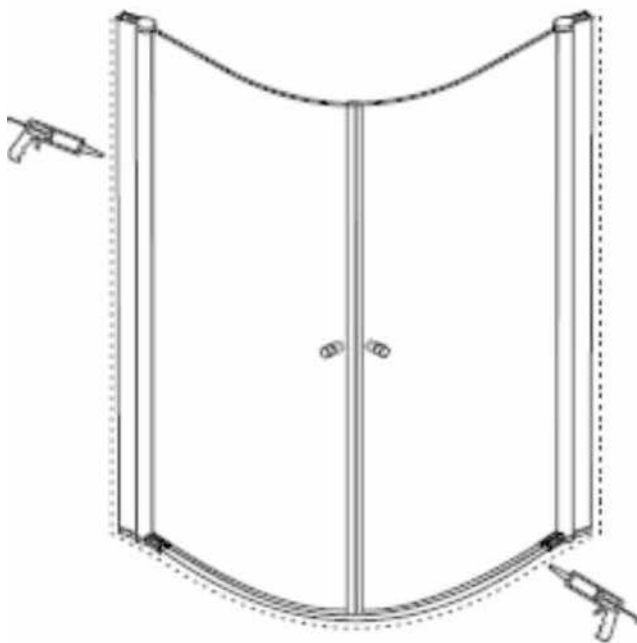



Seal the wall profile with silicone on both sides and allow 24 hours to pass before first use.

Disposal

Should the product no longer be serviceable, every consumer has a statutory obligation to dispose of old appliances separately from domestic waste and dispose of them e.g. at a local authority / district collection point.

Our service

You will receive prompt professional advice from our service team:

- **Germany:** Telephone 01806-63 06 30, Land line 20ct/call, mobile telephone connection 60ct/call max.
- **Austria,** Universal: Telephone +43 / 662-4485 59 landline depending on provider, Home improvement expert service - Otto: +43 / 316-606 159 landline depending on provider, Home improvement expert service - Quelle: +43 / 662-9005 59 landline depending on provider, Home improvement expert service
- **Switzerland,** Quelle: **DE:** +41 / 848 85 85 00, **FR:** +41 / 848 85 85 01, **I:** +41 / 848 858 530
Ackermann: **DE:** +41 / 848 85 85 11, **FR:** +41 / 848 85 85 21, **I:** +41 / 848 858 530
- **The Netherlands:** call center 0900-1901 (15ct/min.)

In order to assist you more efficiently, please tell us the:

product designation: Circular Shower „Florenz“ 93279442–34818506
and **item number** you used to order the item (see invoice).

Imported by baumarkt direkt GmbH & Co KG, Alter Teichweg 25, D-22081 Hamburg

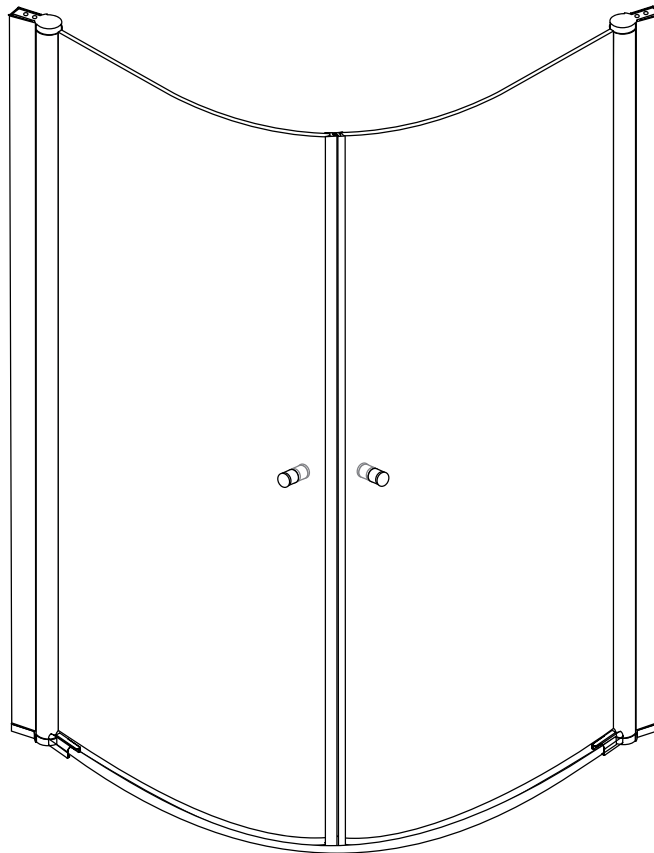

Douche courbe „Florenz“

93279442-34818506

900x900x1900 mm

D

**Aufbauanleitung
Runddusche**

I

**Istruzioni d'installazione
Doccia circolare**

GB

**Installation Instruction
Circular Shower**

F

**Instructions d'installation
Douche courbe**

D: Nachdruck, auch auszugsweise, nicht gestattet! **GB:** Reproduction, even in extracts, is not permitted! **F:** Toute reproduction de ce mode d'emploi même par extraits est interdite ! **IT:** È vietata la riproduzione, anche parziale. **NL:** Nadruk, ook slechts gedeeltelijk, niet toegestaan!

Instruction No. 201901131153296121026804

**IMPORTANT, CONSERVER CE DOCUMENT POUR TOUTE RÉFÉRENCE
ULTÉRIEURE ! À LIRE ATTENTIVEMENT !**

Utilisation conforme à la destination

- Cet article est un ensemble de douche préfabriqué.
- Cet article n'est destiné qu'à un usage de type privé.



Avis de sécurité

- Risque d'étouffement / de blessure ! Ne laissez pas les enfants jouer avec l'emballage car ils pourraient s'étouffer avec le film ou se blesser avec les matériaux d'emballage.
- Veillez à ce que les enfants ne portent pas à la bouche de petits éléments comme les écrous, rondelles de couverture ou autres. Ils pourraient les avaler et s'étouffer avec.
- Risque de dégradations ! Avant le montage, merci de lire très attentivement les instructions de montage et de vérifier que le produit n'a pas été endommagé au cours du transport. Merci de procéder au montage de l'article avec de grandes précautions.
- L'article ne peut être assemblé que par du personnel compétent. Il est conseillé de procéder au montage à deux personnes.
- Risque de blessure ! Lors du montage, prenez en compte le fait que le produit présente plusieurs arêtes vives.
- Ne montez l'article que contre des murs massifs et adaptés.
- **Attention** : La fixation des éléments de mobilier au mur doit être effectuée par du personnel compétent, car des chevilles adaptées au mur sont nécessaires pour le montage.
- Assurez-vous qu'aucun câble ou tuyau ne se trouve dans les zones de perçage.
- Avant le perçage, inspectez les zones avec un détecteur de métaux.
- Manipulez les surfaces en verre avec précaution ! Pendant l'assemblage, maintenez fermement les surfaces en verre pour éviter tout risque de chute.
- Isolez le pare-douche depuis l'extérieur avec de la silicone. N'utilisez la douche que 24 heures après l'application de la silicone.
- Pour le raccordement du receveur de douche au système d'évacuation des eaux domestiques, un siphon classique doté d'un tuyau d'évacuation d'eau flexible doit être utilisé.
- Merci de contacter le service clientèle pour toute commande de pièces détachées (voir la liste des pièces).
- Le verre de sécurité trempé est un verre flotté thermiquement précontraint. La précontrainte s'effectue par traitement thermique, et en cas de bris, le bris de verre typique du verre de sécurité trempé se produit, avec de petits fragments de verre la plupart du temps émoussés. Le risque de blessure est ainsi fortement réduit.

Instructions d'entretien

Pour le nettoyage et l'entretien, utilisez une éponge ou un chiffon doux. Un nettoyant ménager doux et respectueux de l'environnement suffit. N'utilisez jamais de produits de nettoyage agressifs ou contenant des solvants. Pour le nettoyage, n'utilisez jamais d'objets pointus, de laine métallique, de produits chimiques ou de produits à récurer contenant du sable. Ils entraîneront une dégradation de la surface et une privation de la garantie. Les dépôts légers de calcaire peuvent être éliminés sans efforts avec un peu de vinaigre de cuisine.

Nettoyez les surface vitrées avec un chiffon humide et un peu de nettoyant à vitres, puis essuyez-les avec un chiffon sec.

Outils nécessaires

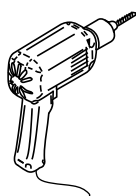
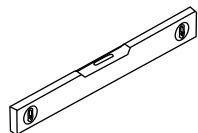
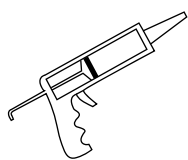

Ø 6mm

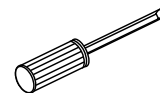



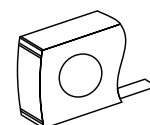
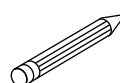
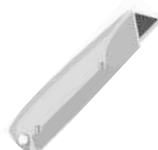
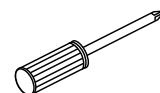





Ø 3.2mm



**En raison du poids important de ce produit,
le montage peut nécessiter deux personnes.**

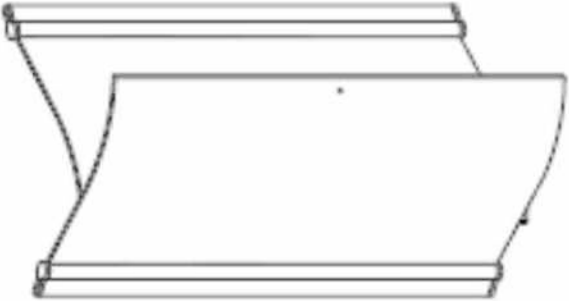

Contenu de l'emballage

1 x instructions pour l'installation	→	
[1] 8x cheville murale* [2] 8x vis 4x35*	→	
[3] 2 x support mural	→	
[4] 8 x vis 4x6 [5] 8 x cache-vis	→	
[6] 2 x déflecteur d'eau	→	
[7] 2 x panneau de porte	→	
[8] 2 x joint magnétique	→	
[9] 2 x poignée	→	
[10] 2 x clips	→	
[11] 1 x joint en aluminium	→	

Dessin de montage

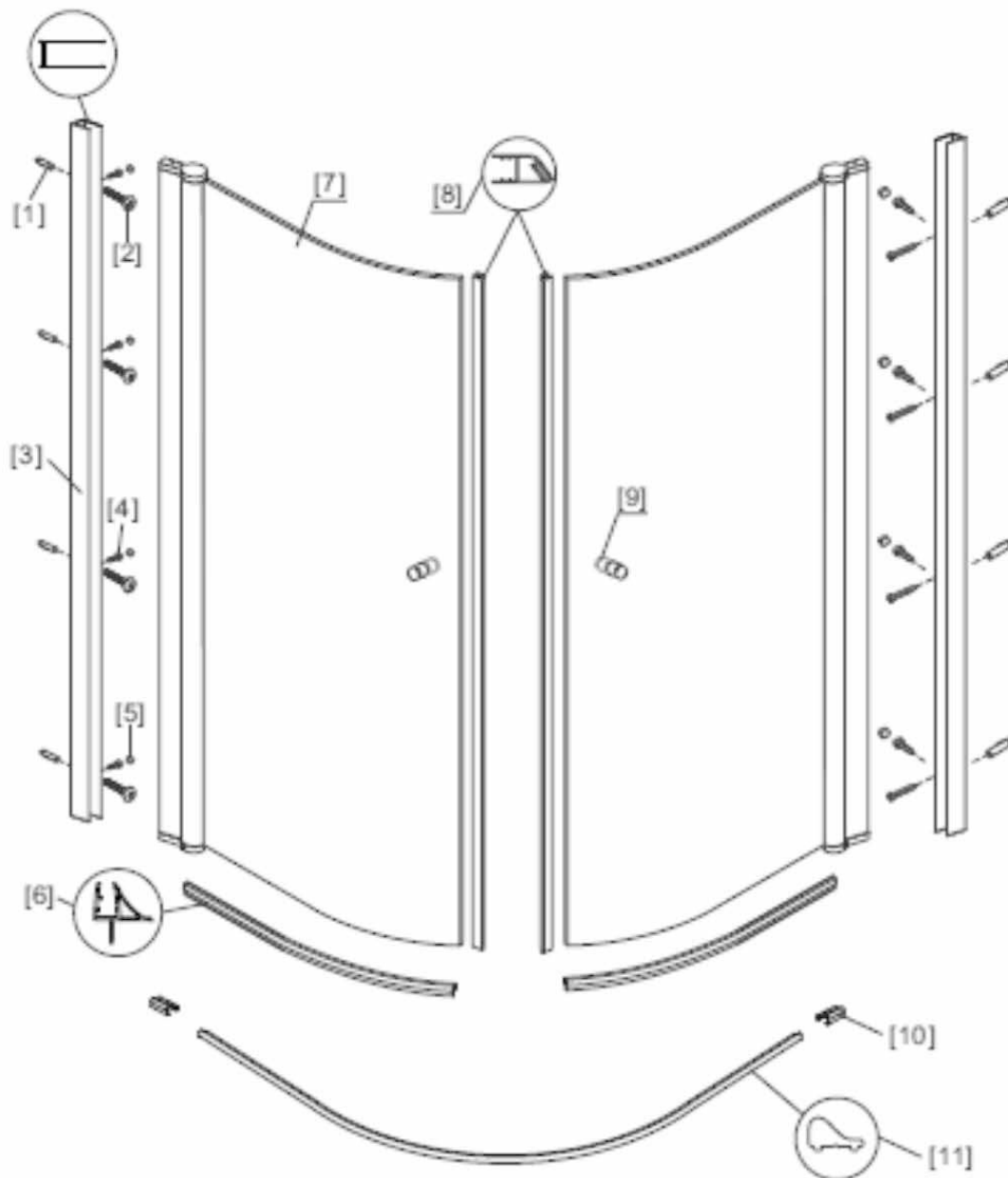

- [1] 8x cheville murale*
- [2] 8x vis 4x35*
- [3] 2 x support mural
- [4] 8 x vis 4x6
- [5] 8 x cache-vis
- [6] 2 x déflecteur d'eau

- [7] 2 x panneau de porte
- [8] 2 x joint magnétique
- [9] 2 x poignée
- [10] 2 x clips
- [11] 1 x joint en aluminium

* non inclus

Étapes de montage

Étape 1

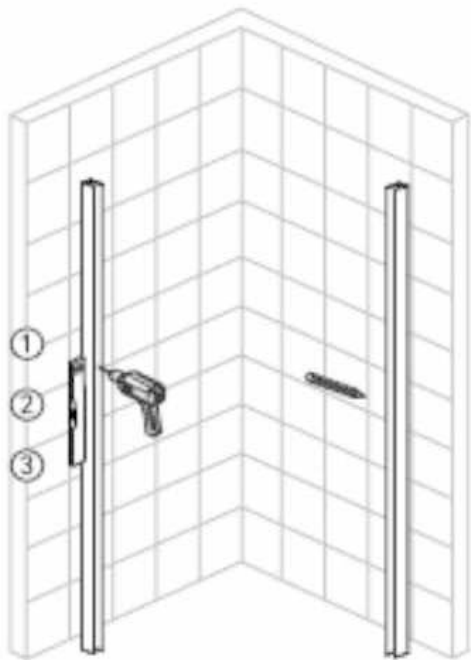

La profondeur de l'alésage doit être supérieure à la longueur de la cheville.

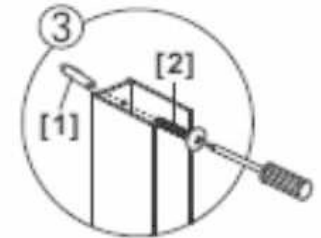
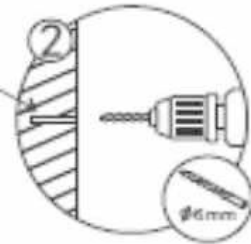
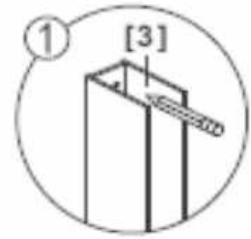

Étape 2

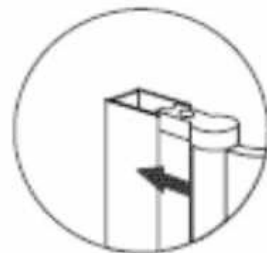
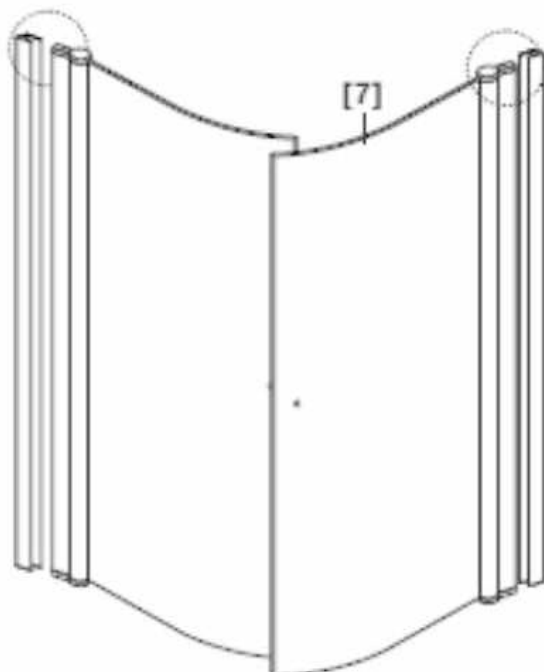

Étape 3

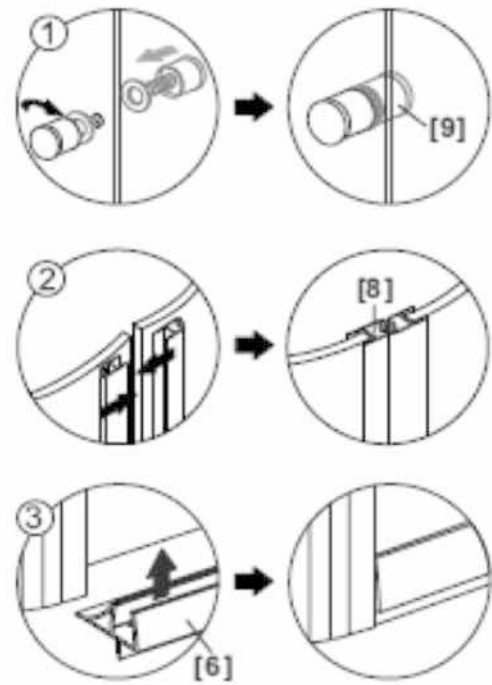
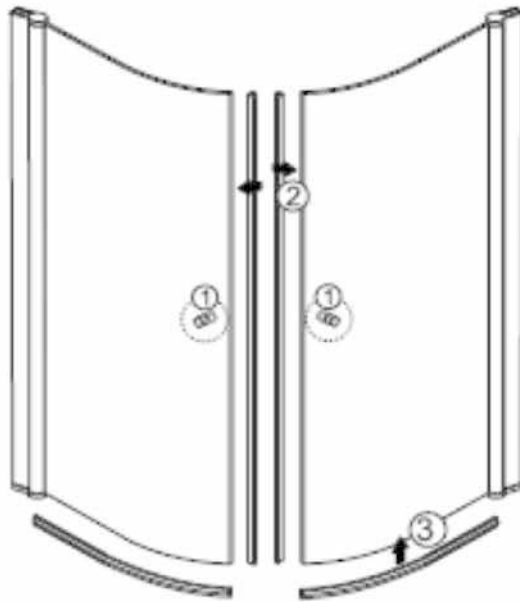

Étape 4

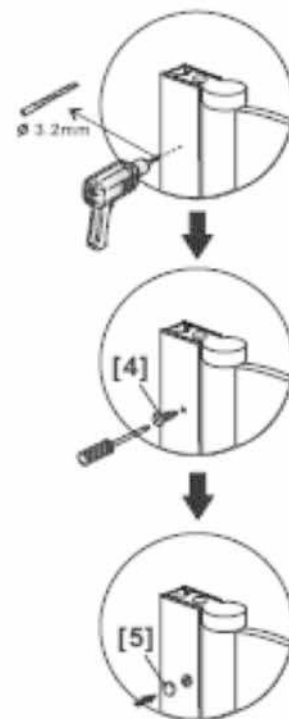
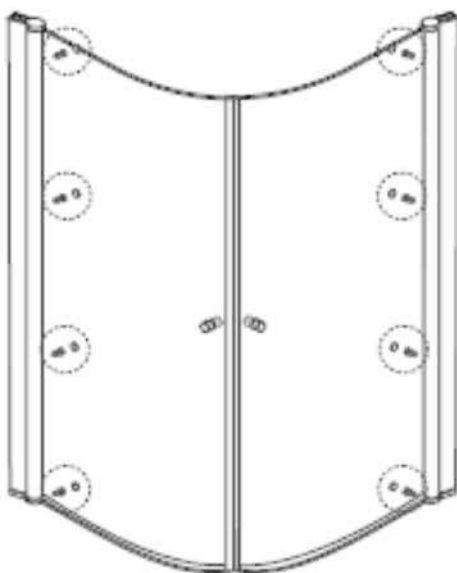

Vue intérieure

Étape 5

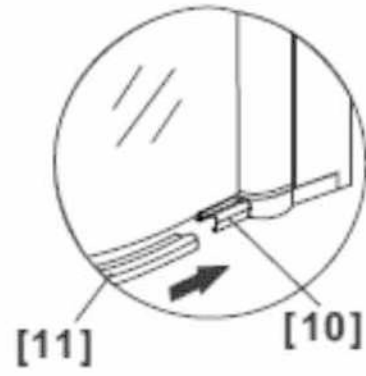
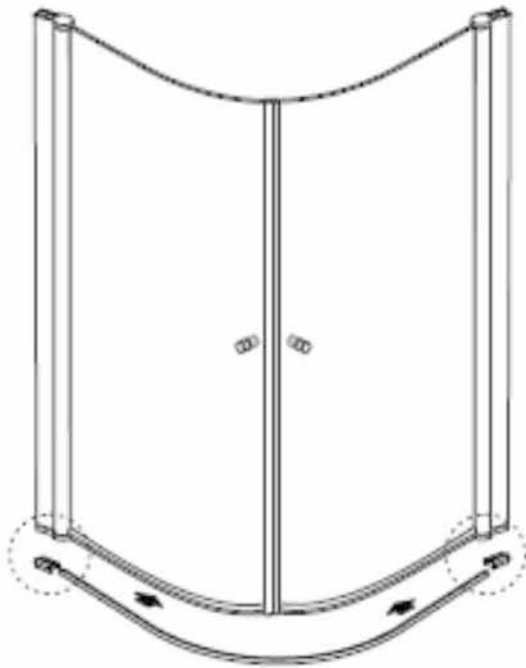

Étape 6

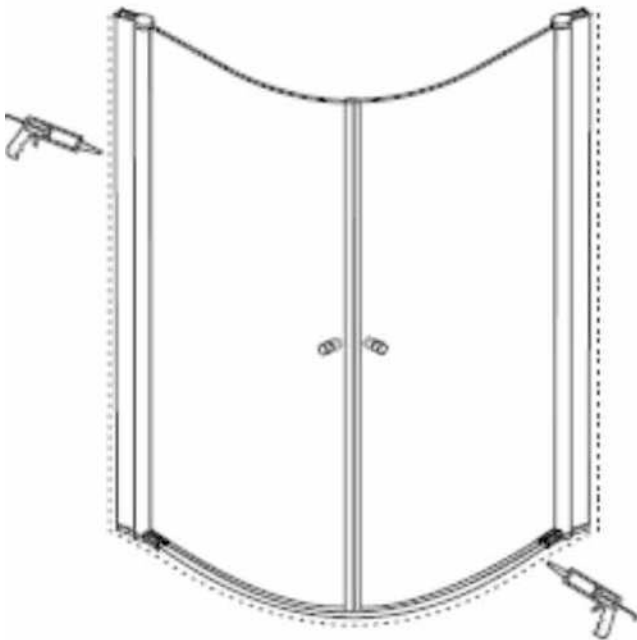



Étanchéifiez la cimaise des deux côtés
avec du silicone et attendez 24 heures
avant la première utilisation.

Traitement des déchets

Si cet article devient inutilisable, chaque utilisateur est légalement obligé de traiter les vieux appareils ménagers séparément des déchets domestiques, par exemple en les déposant dans un lieu de collecte de sa commune / de son quartier.

Notre service

Vous pourrez bénéficier immédiatement de conseils techniques en contactant notre équipe de services :

- **Allemagne** : téléphone 01806-63 06 30, depuis un poste fixe 20 c/appeil, depuis un mobile
- **Autriche** : Universal: téléphone +43 / 662-4485 59, depuis un poste fixe en fonction de l'opérateur, conseil spécialisé bricolage – Otto: +43 / 316-606 159 depuis un poste fixe en fonction de l'opérateur, conseil spécialisé bricolage – Quelle: +43 / 662-9005 59 depuis un poste fixe en fonction de l'opérateur, conseil spécialisé
- **Suisse**, Quelle: **DE**: +41 / 848 85 85 00, **FR**: +41 / 848 85 85 01, I: +41 / 848 858 530
Ackermann: **DE**: +41 / 848 85 85 11, **FR**: +41 / 848 85 85 21, I: +41 / 848 858 530
- **Pays-Bas** : centre d'appel 0900-1901 (15 c/mn)

Pour nous permettre de vous aider aussi rapidement que possible, merci de préciser :

Le nom de l'article : Douche courbe „Florenz“ 93279442–34818506
et le **numéro d'article** sous lequel vous avez commandé cet article (voir facture).

Importé par baumarkt direkt GmbH & Co KG, Alter Teichweg 25, D-22081 Hamburg

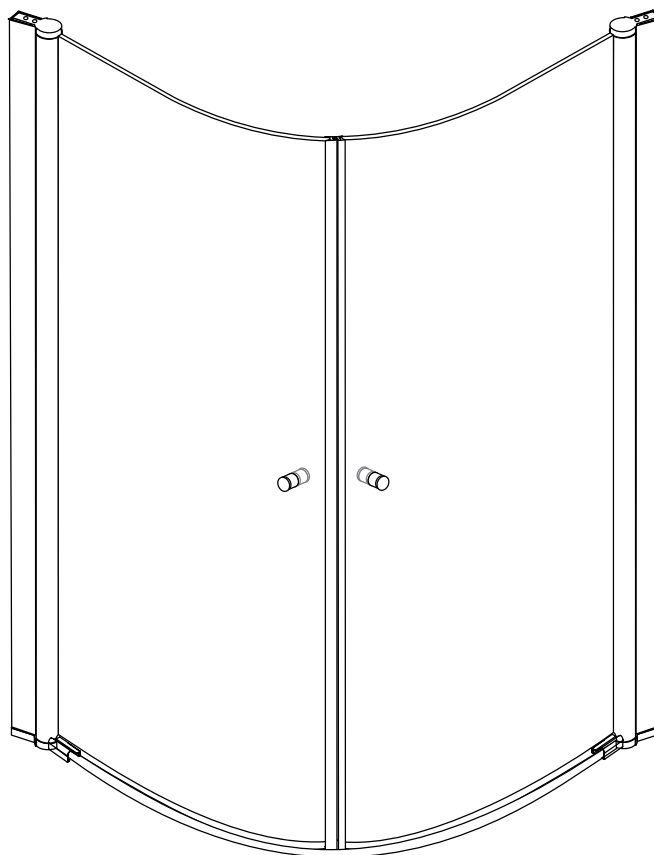

Doccia circolare „Florenz“

93279442-34818506

900x900x1900 mm

D

**Aufbauanleitung
Runddusche**

I

**Istruzioni d'installazione
Doccia circolare**

GB

**Installation Instruction
Circular Shower**

F

**Instructions d'installation
Douche courbe**

D: Nachdruck, auch auszugsweise, nicht gestattet! **GB:** Reproduction, even in extracts, is not permitted! **F:** Toute reproduction de ce mode d'emploi même par extraits est interdite ! **IT:** È vietata la riproduzione, anche parziale. **NL:** Nadruk, ook slechts gedeeltelijk, niet toegestaan!

Istruzione n° 201901131153296121026804

IMPORTANTE, CONSERVARE IL PRESENTE DOCUMENTO PER UN FUTURO RIFERIMENTO!
LEGGERE CON ATTENZIONE!

Uso conforme

- Il presente articolo è un'unità prefabbricata per la doccia.
- L'articolo è destinato esclusivamente all'uso privato.



Avvisi di sicurezza

- Pericolo di soffocamento / lesioni! L'imbballaggio non è un giocattolo per bambini. Potrebbero soffocarsi con la pellicola o ferirsi con l'involucro.
- Fare attenzione che i bambini non mettano in bocca piccole parti quali bulloni, tappi ecc. L'ingerimento potrebbe comportare il soffocamento.
- Pericolo di danneggiamento! Prima del montaggio, leggere attentamente le istruzioni di montaggio e accertarsi dell'assenza di danni da trasporto. Installare l'articolo con la massima cura.
- Il montaggio dell'articolo è consentito solo alle persone esperte. Si consiglia di effettuare il montaggio con l'aiuto di una seconda persona.
- Pericolo di lesioni! Durante il montaggio, fare attenzione ai bordi taglienti di alcune parti.
- Montare l'articolo esclusivamente a ridosso di una parete adatta e massiccia.
- **Attenzione:** Il fissaggio dell'arredo alla parete va effettuato da una persona esperta, dato che il montaggio richiede l'utilizzo di tasselli adatti alla parete.
- Accertarsi dell'assenza di cavi e tubi nei punti di perforazione.
- Controllare la parete con un cercametri prima di effettuare i fori.
- Prestare attenzione alle superfici in vetro! Tenerle ben salde durante la il loro montaggio per evitare che cadano.
- Impermeabilizzare la parete della doccia all'esterno con del silicone. Dopo l'impermeabilizzazione, attendere 24 ore prima dell'utilizzo della doccia.
- Per l'allacciamento della vasca alla rete di scarico, si consiglia di utilizzare un sifone normale con un tubo di scarico flessibile.
- Per ordinare le parti di ricambio (ved. lista dei ricambi) si prega di rivolgersi al servizio clienti.
- VST (vetro di sicurezza temprato) è un vetro float temprato termicamente. La tempra viene ottenuta tramite un trattamento termico e, in caso di rottura, la lastra VST presenta piccoli cocci di vetro smussati. In questo modo viene ridotto al minimo il rischio di lesioni.

Avvisi per la pulizia

Per la pulizia si consiglia l'utilizzo di una spugna o di un panno morbido. Sono sufficienti i detersivi ecologici e/o delicati. Si sconsiglia l'utilizzo di detersivi aggressivi o contenenti solventi. Non utilizzare oggetti taglienti, lana d'acciaio, agenti chimici o abrasivi contenenti sabbia. Potrebbero danneggiare la superficie e comportare di conseguenza la decadenza della garanzia. Le incrostazioni leggere di calcare si possono rimuovere facilmente con dell'aceto.

Pulire le superfici in vetro con un panno morbido e detergente per vetro e asciugarle successivamente con un panno asciutto.

Attrezzi necessari

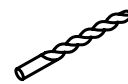
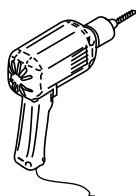
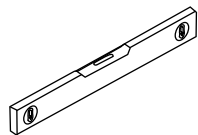
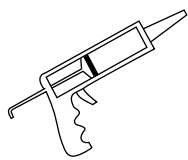

Ø 6mm

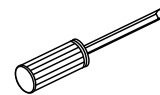



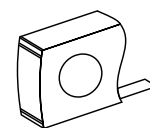
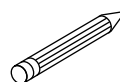
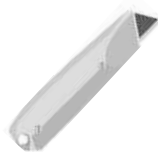
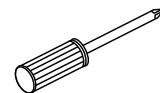





Ø 3.2mm

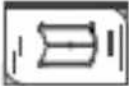

L'elevato peso del prodotto potrebbe rendere necessario l'aiuto di una seconda persona per il montaggio

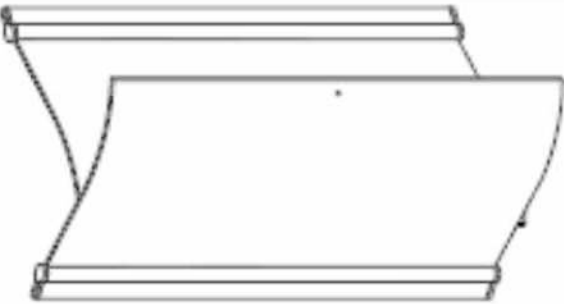

Contenuto della confezione

1x Istruzioni di montaggio	→	
[1] 8x Tasselli da muro* [2] 8x Viti 4x35*	→	
[3] 2x Montanti a muro	→	
[4] 8x Viti 4x6 [5] 8x Tappi coprivite	→	
[6] 2x Deflettori di spruzzi	→	
[7] 2x Ante	→	
[8] 2x Guarnizioni magnetiche	→	
[9] 2x Set di maniglie	→	
[10] 2x Clips	→	
[11] 1x Guarnizione in alluminio	→	

Schema di montaggio

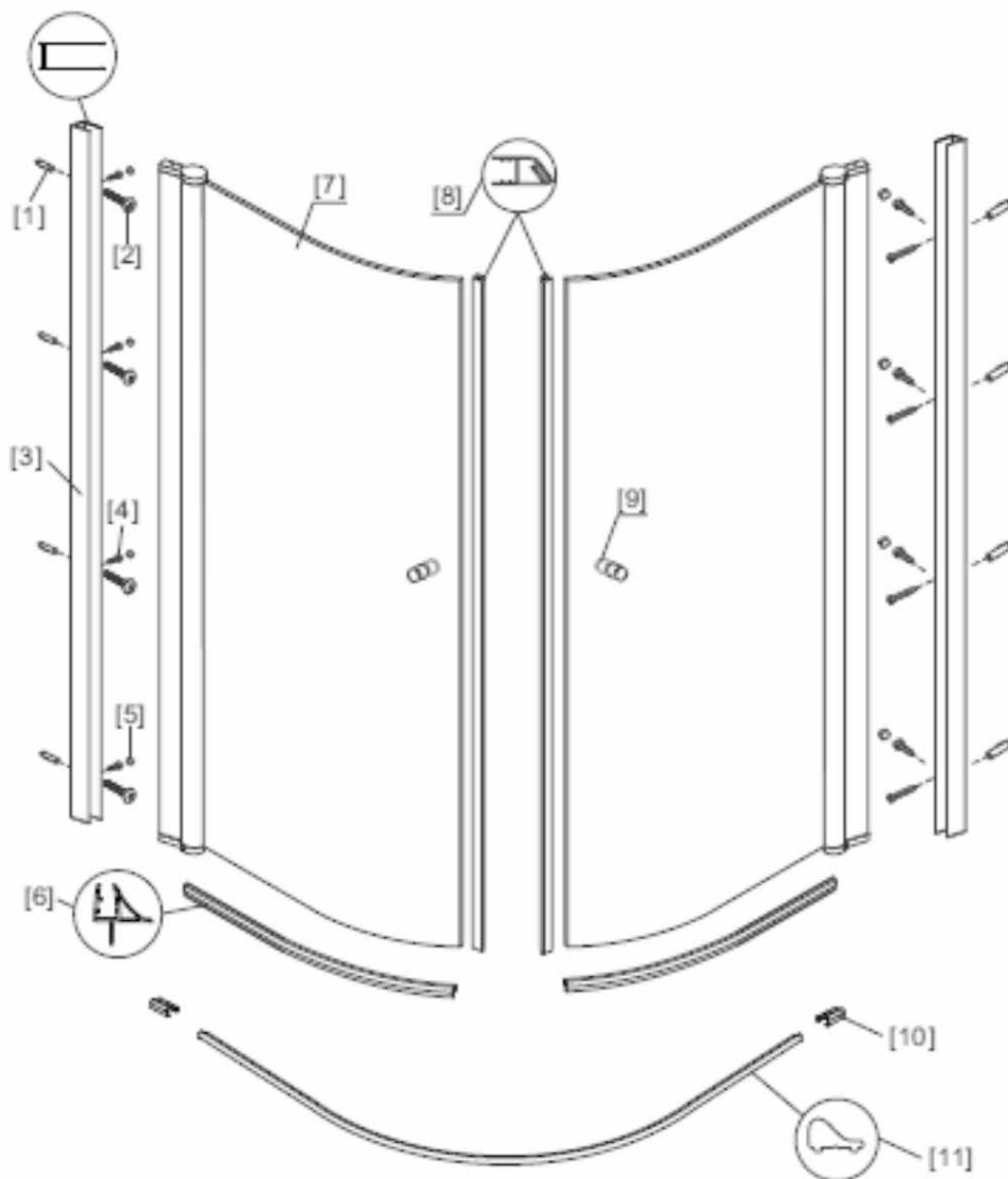

- [1] 8x Tasselli da muro*
- [2] 8x Viti 4x35*
- [3] 2x Montanti a muro
- [4] 8x Viti 4x6
- [5] 8x Tappi coprivite
- [6] 2x Deflettori di spruzzi

- [7] 2x Ante
- [8] 2x Guarnizioni magnetiche
- [9] 2x Set di maniglie
- [10] 2x Clips
- [11] 1x Guarnizione in alluminio

* Non inclusi

Fasi di assemblaggio

Fase 1

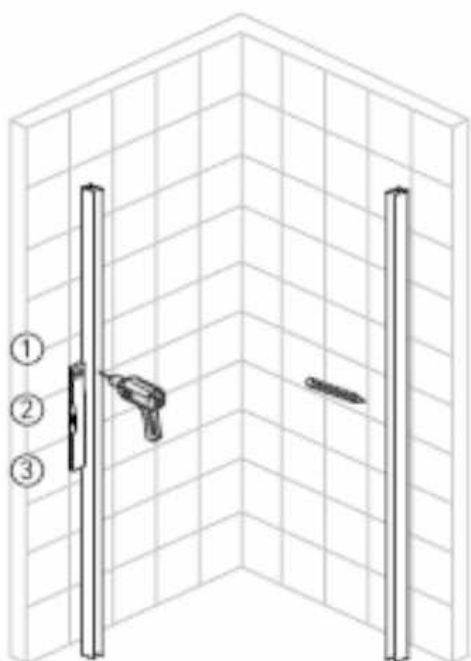

La profondità del foro deve essere maggiore della lunghezza del tassello.

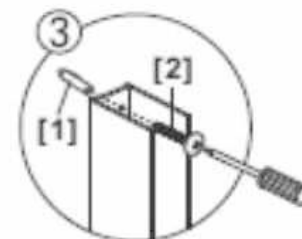
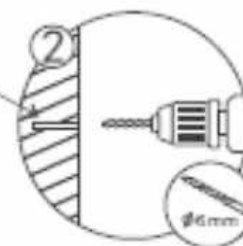
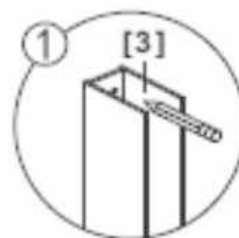

Fase 2

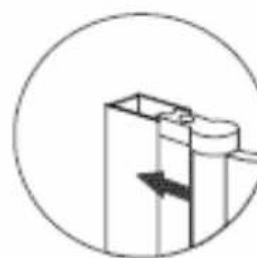
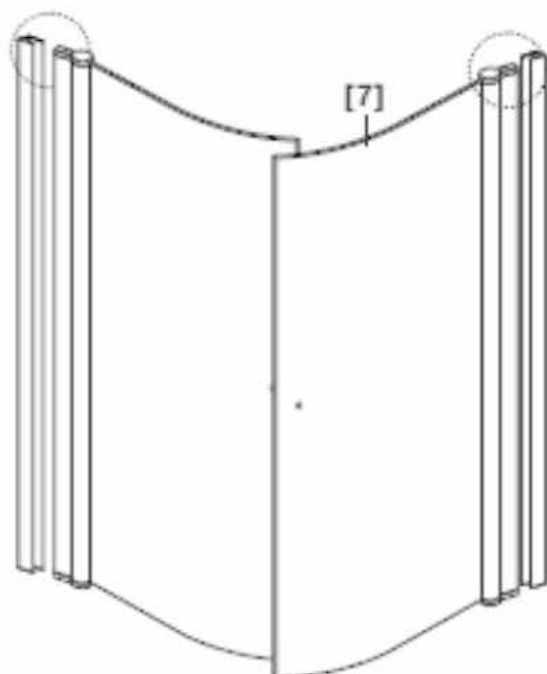

Fase 3

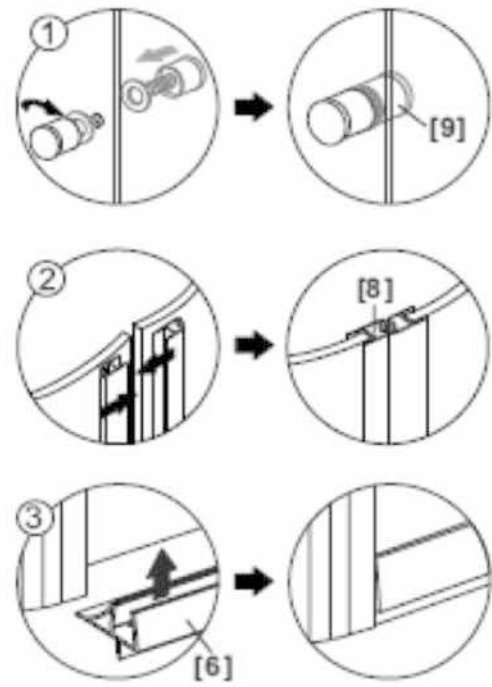
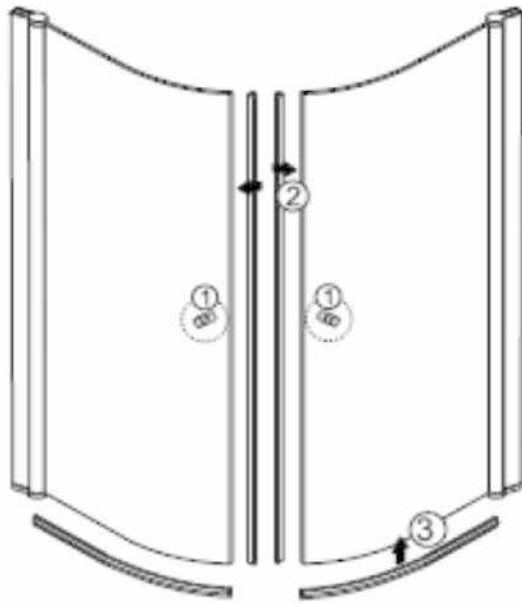

Fase 4

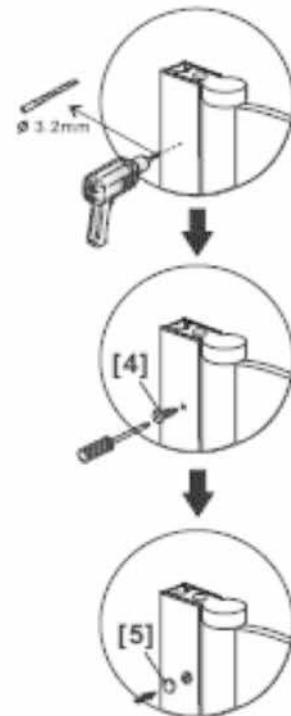
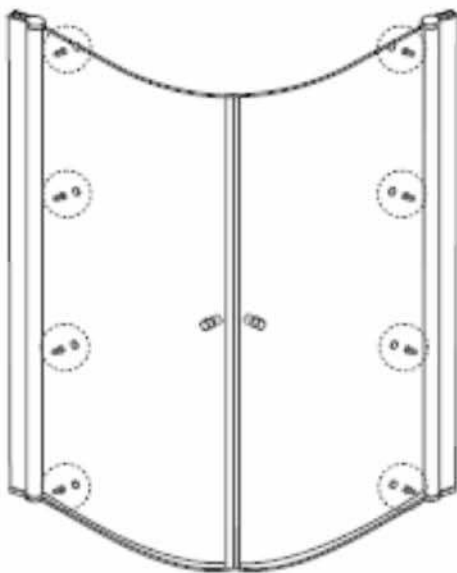

vista interna

Fase 5

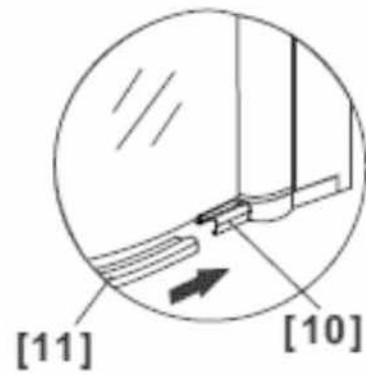
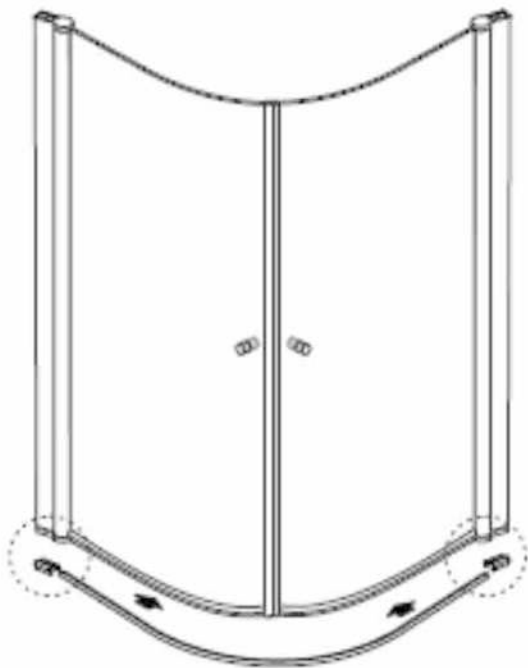

Fase 6

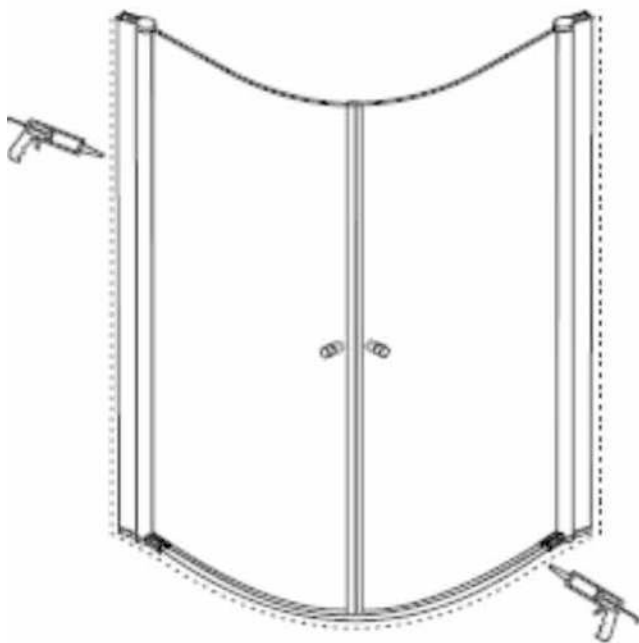

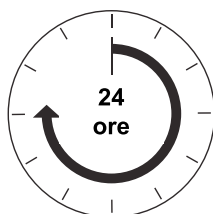

Sigillare il profilo a parete su entrambi i lati
e attendere 24 ore prima del primo utilizzo.

Smaltimento

Qualora l'articolo non dovesse più servire, ogni consumatore è obbligato per legge allo smaltimento separato delle vecchie apparecchiature consegnandole ad esempio all'ecocentro del proprio comune / quartiere.

Il nostro servizio

Il nostro team di servizio vi offre una rapida consulenza specialistica:

- **Germania:** telefono 01806-63 06 30, rete fissa 20ct/chiamata, telefonia mobile max. 60 ct/ chiamata
- **Austria, Universal:** telefono +43 / 662-4485 59, rete fissa a secondo del gestore, consulenza specialistica per il fai da te – Otto: +43 / 316-606 159 rete fissa a secondo del gestore, consulenza specialistica per il fai da te – Quelle: +43 / 662-9005 59 rete fissa a secondo del gestore, consulenza specialistica per il fai da te
- **Svizzera, Quelle:** **DE:** +41 / 848 85 85 00, **FR:** +41 / 848 85 85 01, **I:** +41 / 848 858 530
Ackermann: **DE:** +41 / 848 85 85 11, **FR:** +41 / 848 85 85 21, **I:** +41 / 848 858 530
- **Paesi bassi,** call center 0900-1901 (15ct/min.)

Per poter garantire un celere aiuto, si prega di indicare:

Il **nome dell'articolo:** Doccia circolare „Florenz“ 93279442–34818506
e il **codice articolo** con il quale avete ordinato l'articolo (ved. scontrino).

Imported by baumarkt direkt GmbH & Co KG, Alter Teichweg 25, D-22081 Hamburg

