

MODICA 7

355-97-...-9

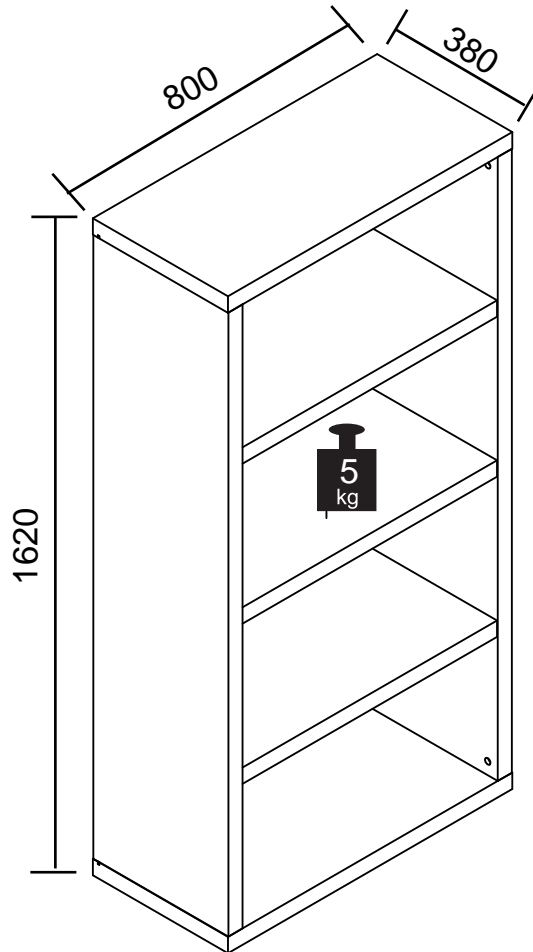

NUMER	L	W	T	COUNT	COLI
1	800	380	40	2	1/1
2	1520	379	40	2	1/1
3	718	360	40	1	1/1
4	718	360	40	2	1/1
5	1530	728	3	1	1/1

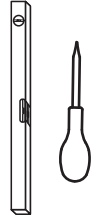
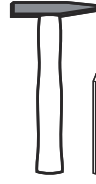
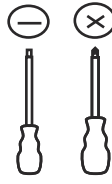
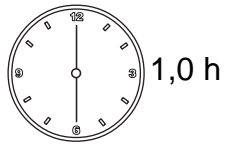
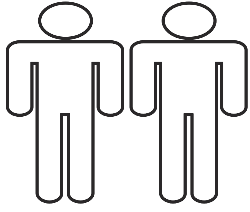
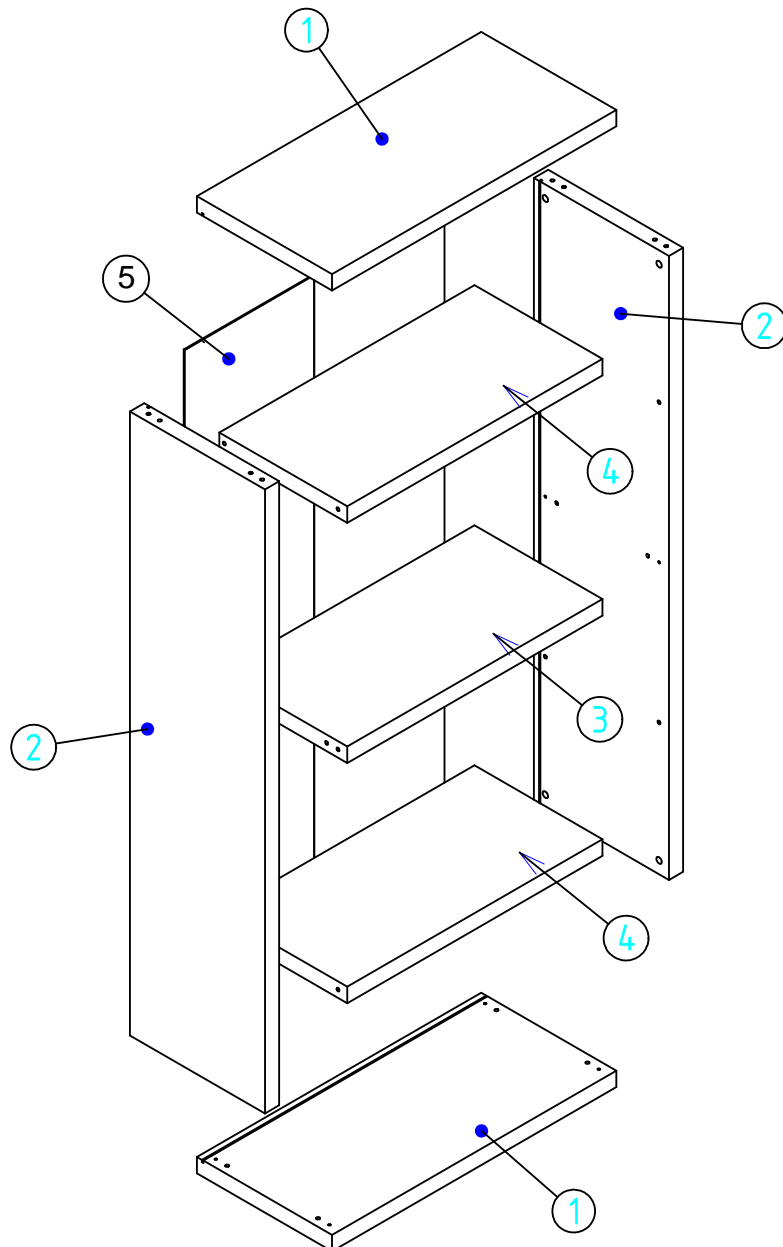
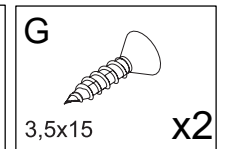
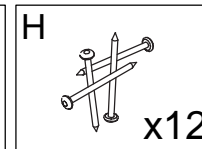
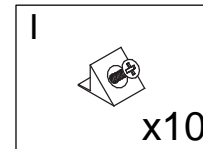
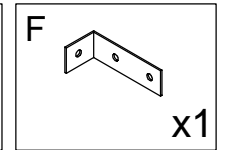
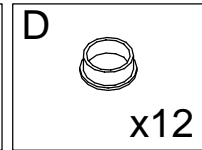
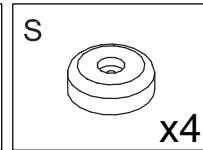
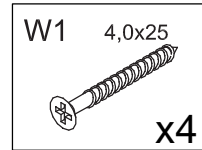
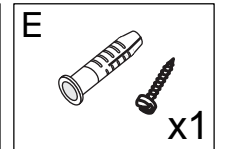
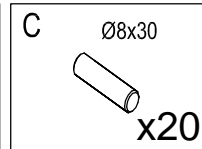
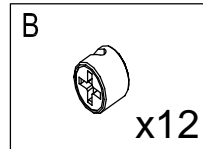
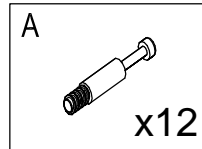

1

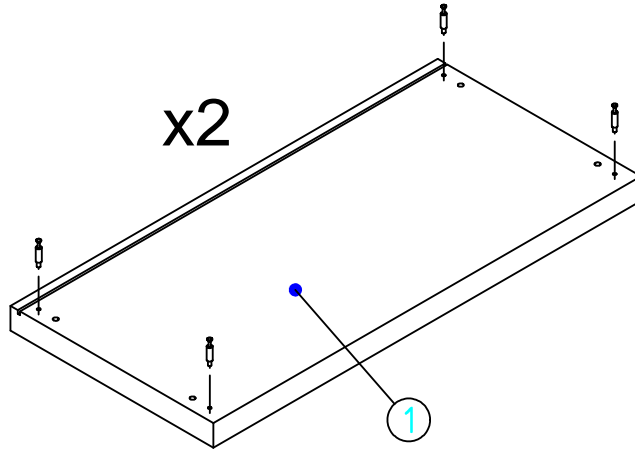
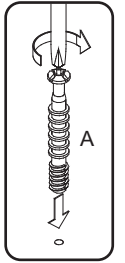
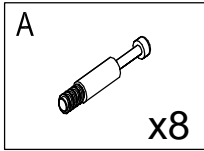

2

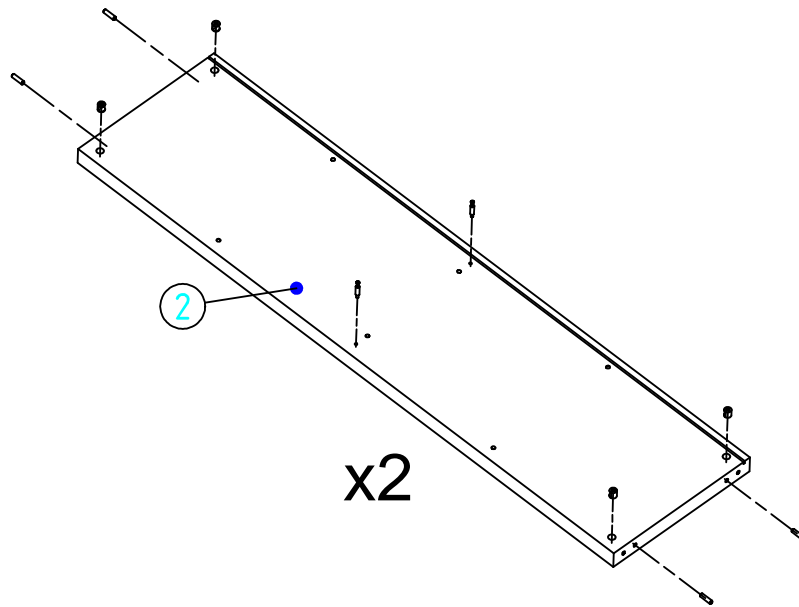
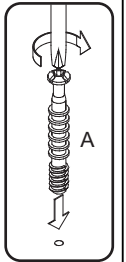
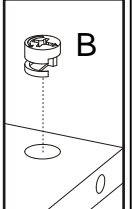
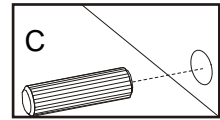
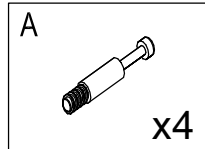
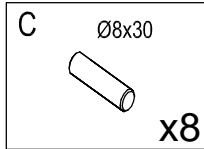
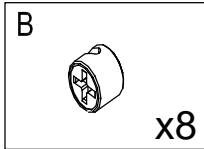

3

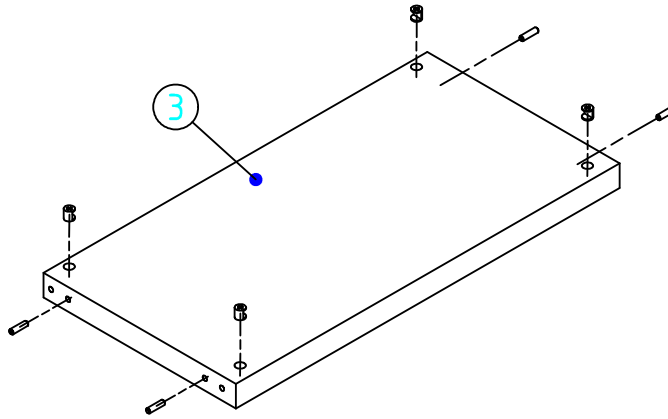
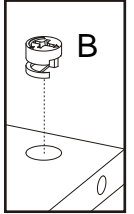
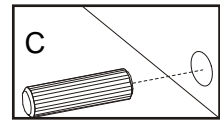
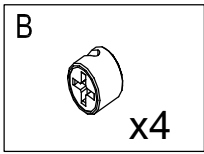
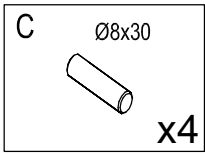

4

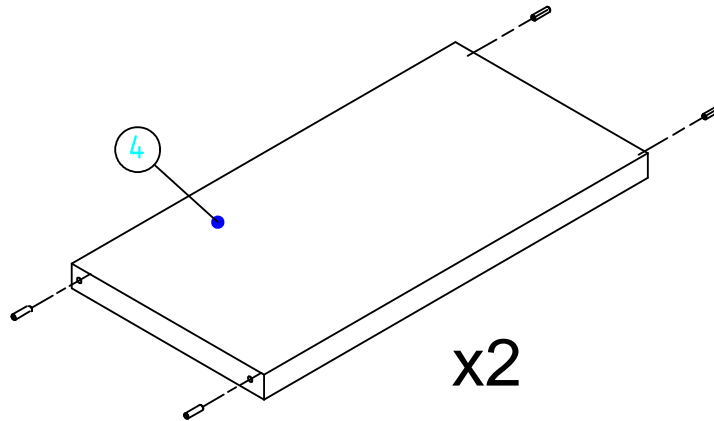
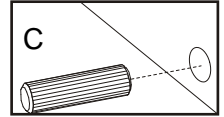
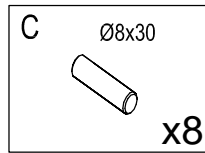

5

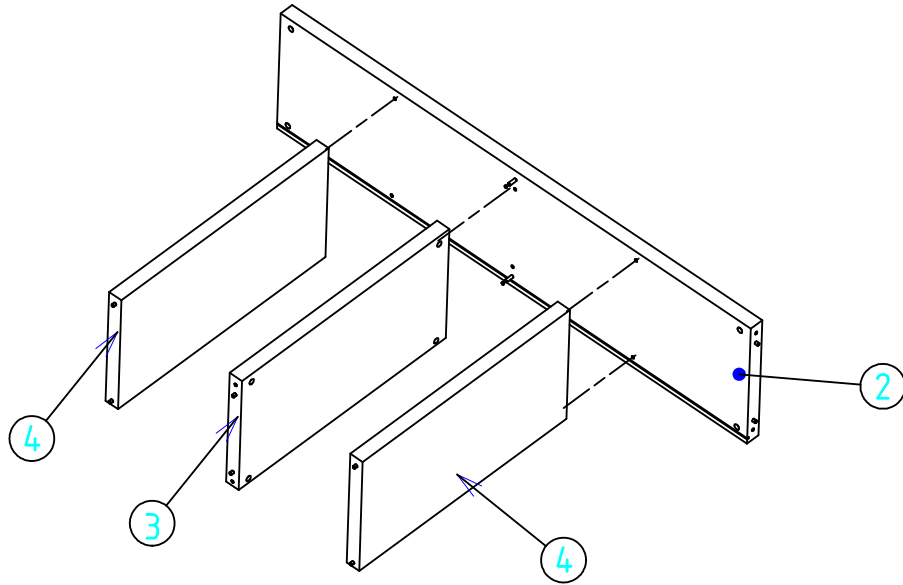
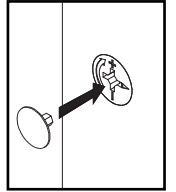
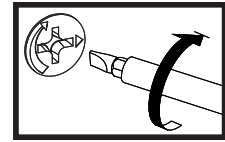
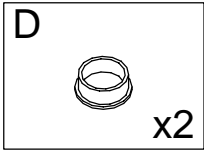

6

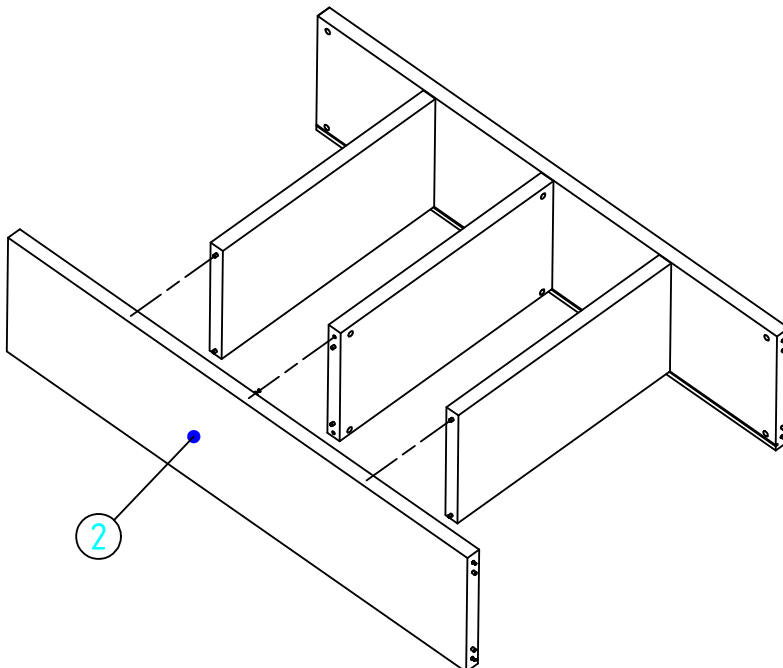
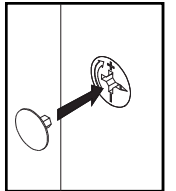
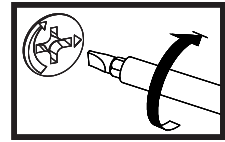
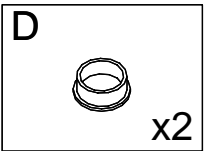

7

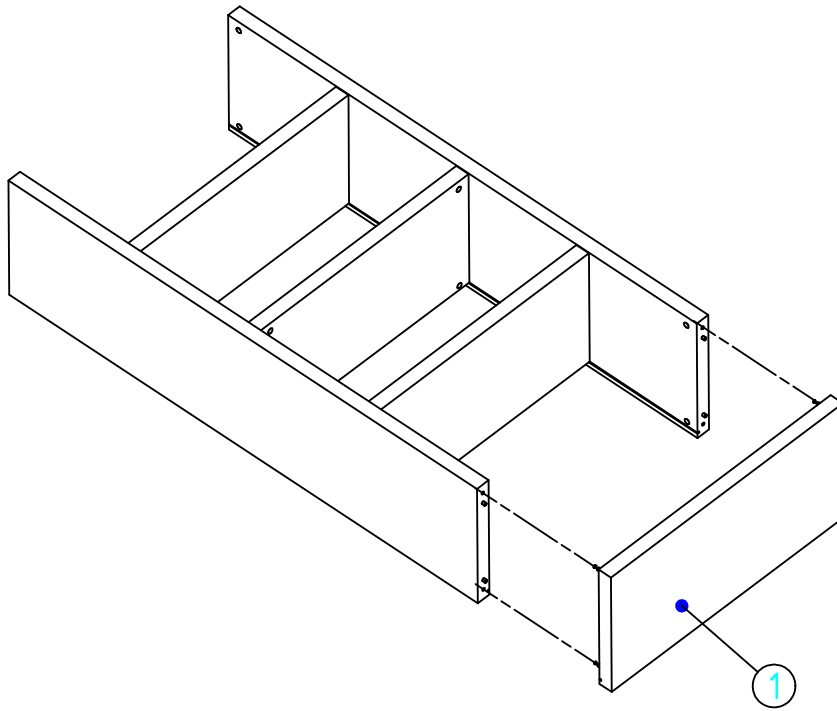
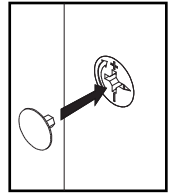
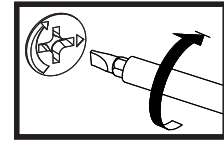
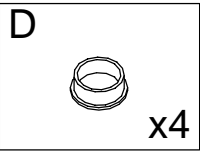

8

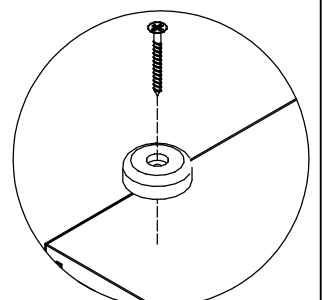
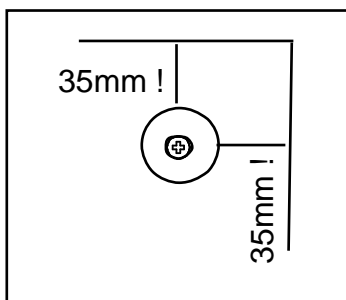
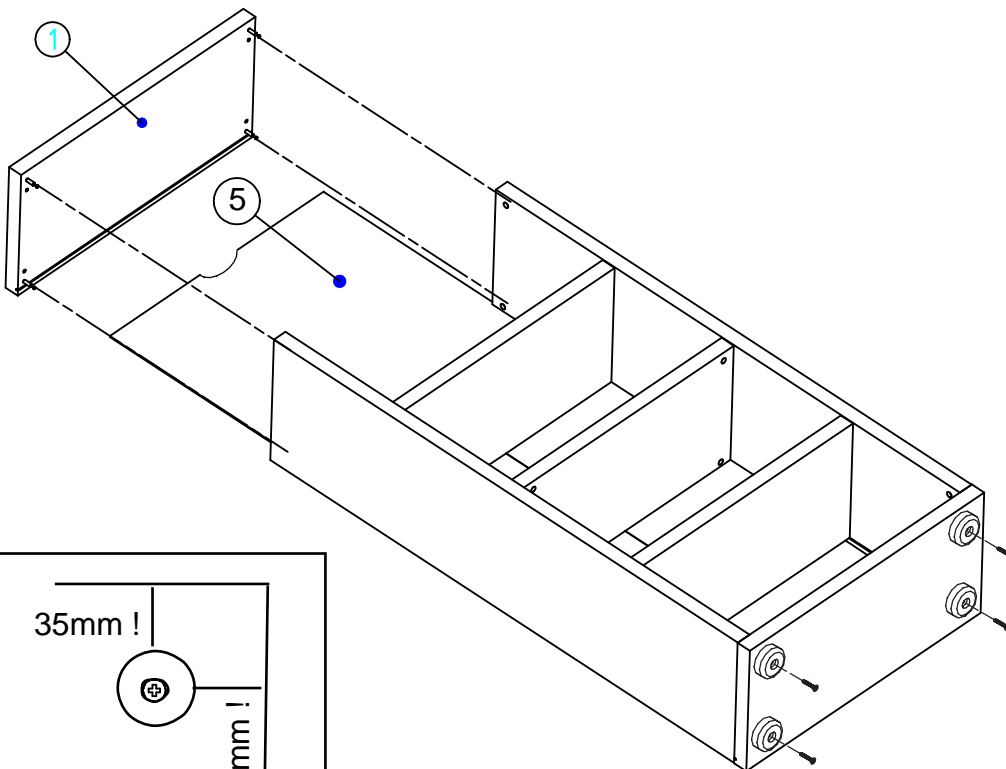
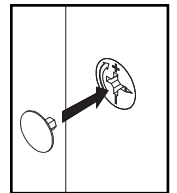
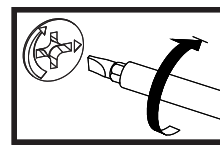
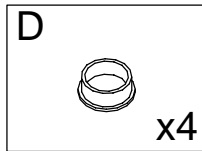
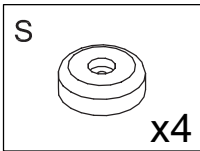
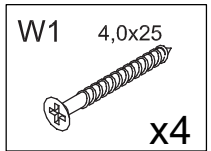

9

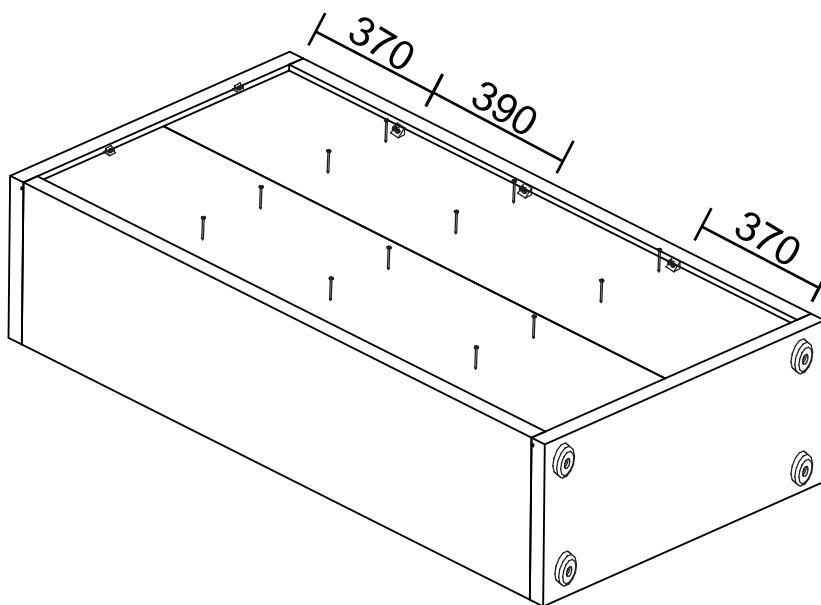
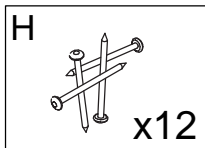
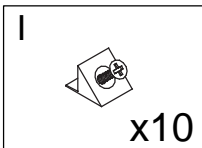

10

