

GOTLAND
8169
8179
2019-07/1

- | | | | |
|-----------|--|-----------|---|
| D | MONTAGEANLEITUNG
BEDIENUNGSANLEITUNG | GB | ASSEMBLY INSTRUCTIONS
INSTRUCTION MANUAL |
| NL | HANDLEIDING VOOR DE MONTAGE
GEBRUIKSAANWIJZING | PL | INSTRUKCJA MONTAŻU
INSTRUKCJA OBSŁUGI |
| TR | MONTAJ TALIMATI
KULLANIM KLAVUZU | RU | ИНСТРУКЦИЯ ПО МОНТАЖУ
ИНСТРУКЦИЯ ПО ЭКСПЛУАТАЦИИ |
| RO | INSTRUCȚIUNI DE INSTALARE
INSTRUCȚIUNI DE UTILIZARE | IT | ISTRUZIONI DI MONTAGGIO
MANUALE DI ISTRUZIONI |
| FR | NOTICE DE MONTAGE
MANUEL INSTRUCTIONS | SK | MONTÁŽNY NÁVOD
NÁVOD NA POUŽITIE |
| HU | KÖZGYŰLÉS UTASÍTÁSOK
KEZELÉSI UTASÍTÁS | CZ | MONTÁŽNÍ NÁVOD
NÁVOD K POUŽITÍ |
| SI | NAVODILA ZA MONTAŽO
NAVODILA ZA UPORABO | PT | INSTRUÇÕES DE MONTAGEM
MANUAL DO USUÁRIO |
| ES | INSTRUCCIONES DE MONTAJE
MANUAL DEL USUARIO | HR | UPUTE ZA MONTAŽU
UPUTE ZA UPOTREBU |

Name · Naam · Nazwa · İsim · Название · Nume · Nome · Názov · Názov ·
 Název · Neve

GOTLAND; HOERNUM; TRONDHEIM

Typ · Type · Tip · Тип · Típo · Típus

☎ 8169+0088; 8179+0088

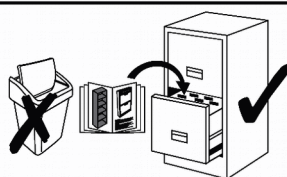

A

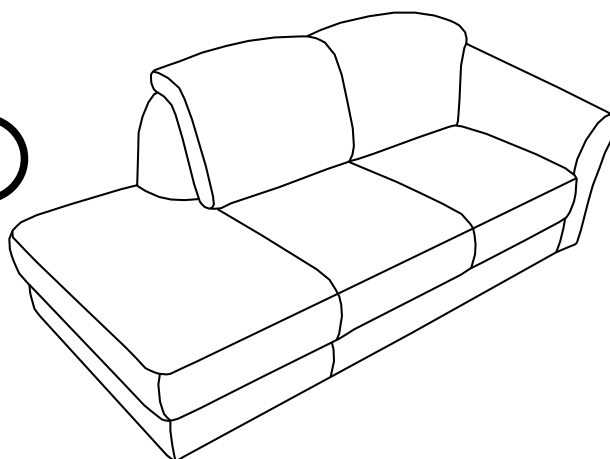

B

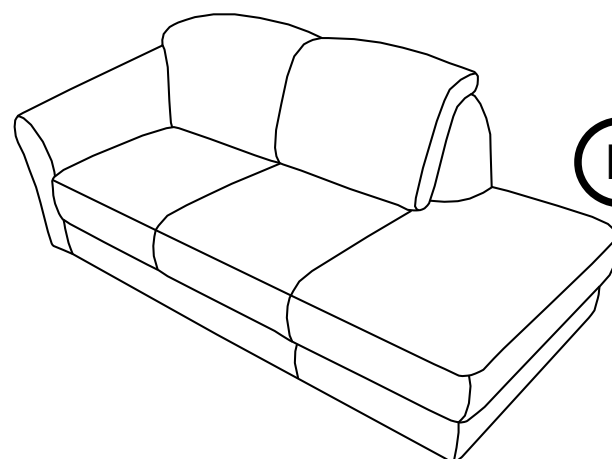

v1

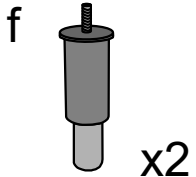
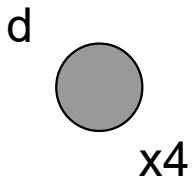
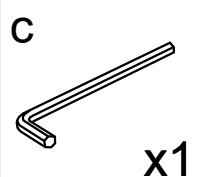
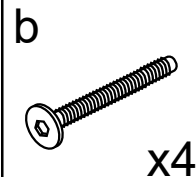
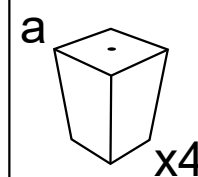
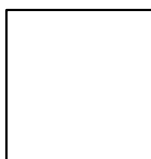

v2

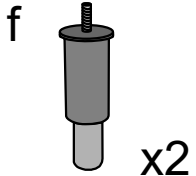
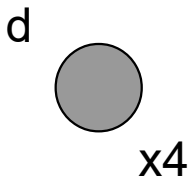
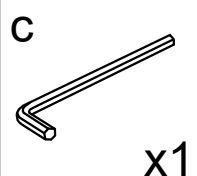
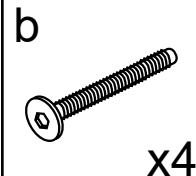

v3

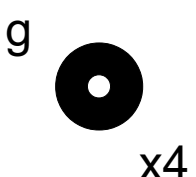
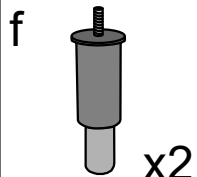
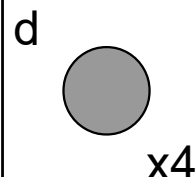
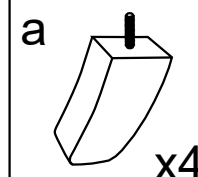
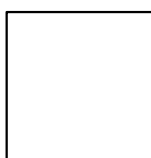

v4

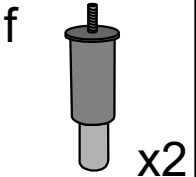
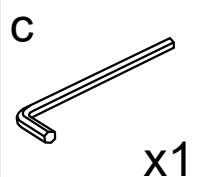
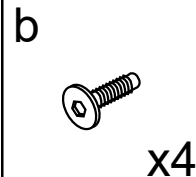
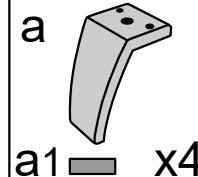

0088

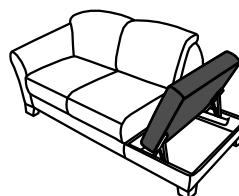

v1 v2

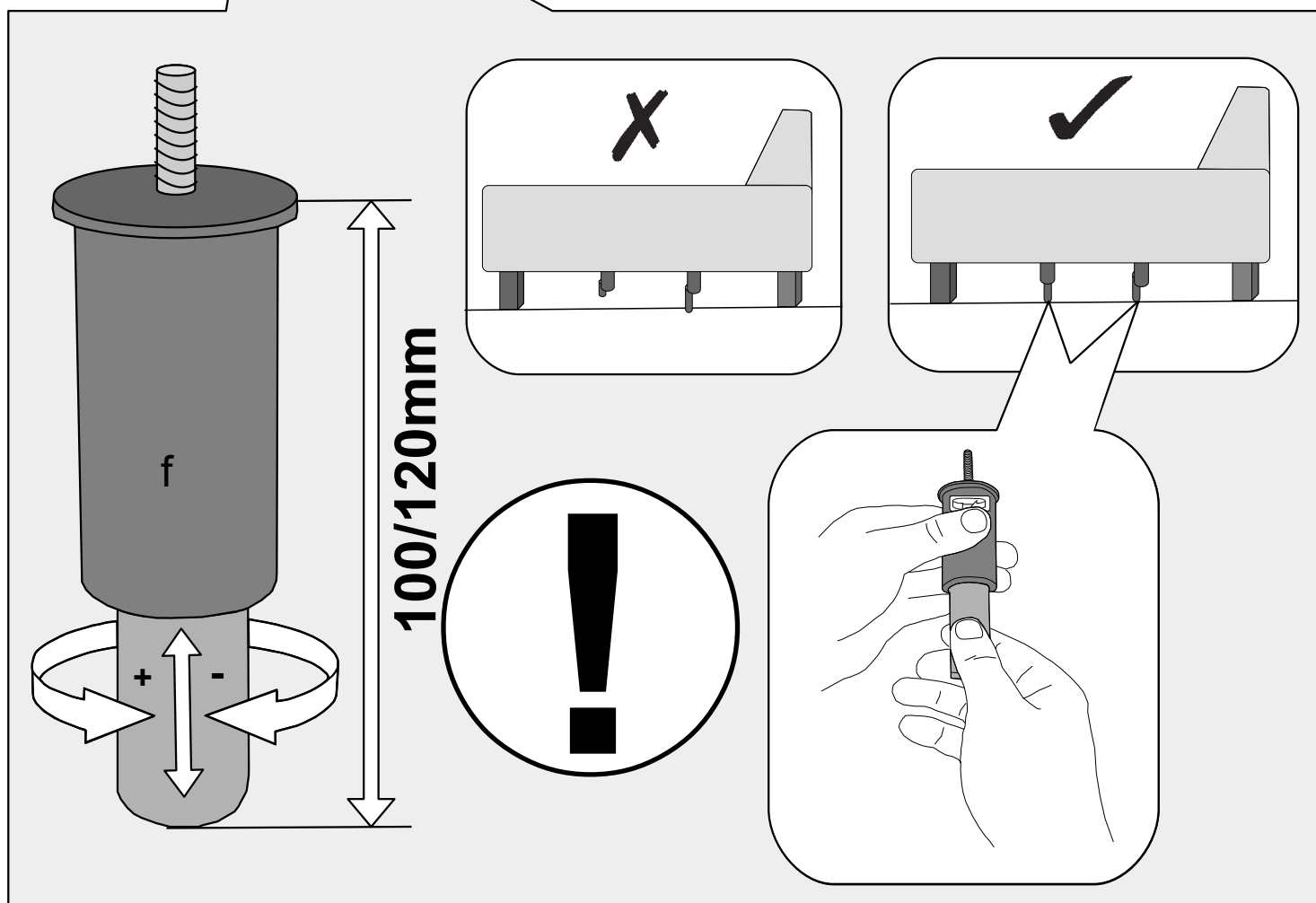
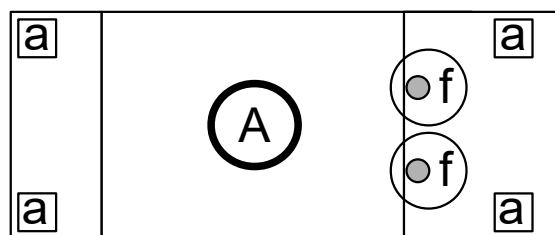
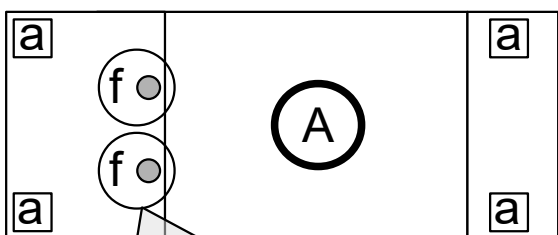
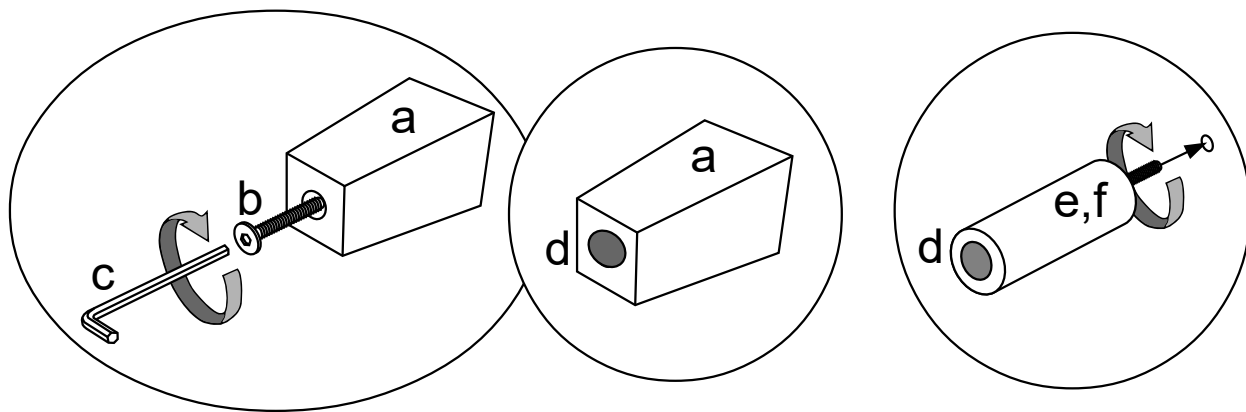
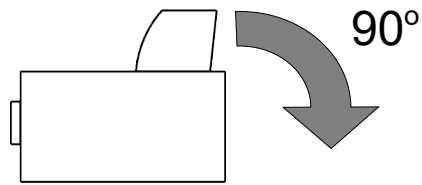

v3

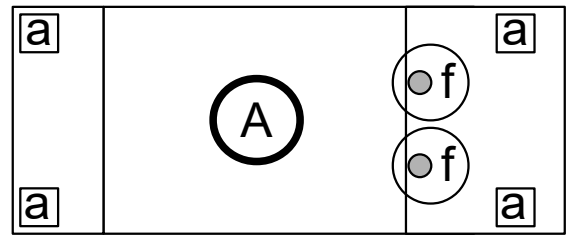
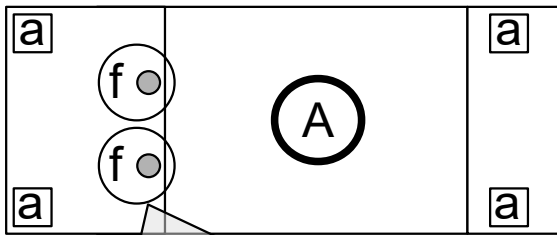
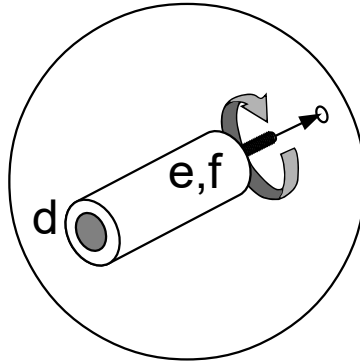
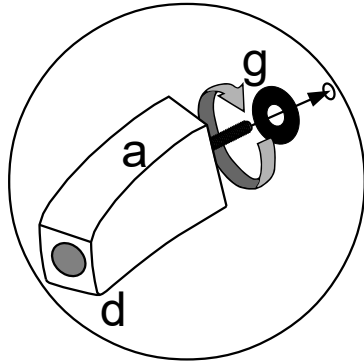
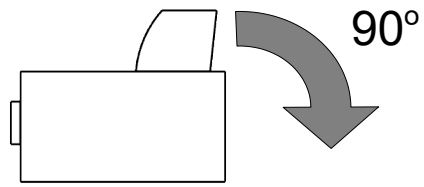

f

100/120mm

X

✓

!

+

-

This large diagram illustrates the correct installation of component 'f'. On the left, a vertical assembly is shown with a threaded rod passing through a cap and component 'f'. A dimension line indicates a height of 100/120mm. Below component 'f', a vertical double-headed arrow is labeled with '+' and '-' signs, and curved arrows indicate rotation. To the right, two inset diagrams show correct and incorrect installation methods. The top-left inset, marked with a large 'X', shows a component being pushed down without the rod. The top-right inset, marked with a checkmark, shows the component being pushed down with the rod. A large exclamation mark in a circle is positioned below these insets. At the bottom right, a hand is shown holding the component with the rod, demonstrating the correct grip.

v4

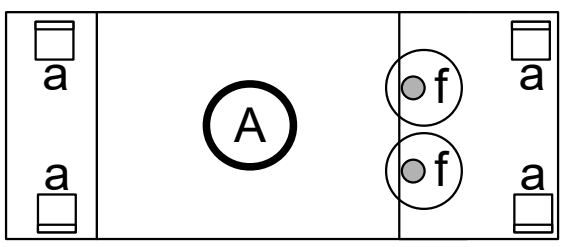
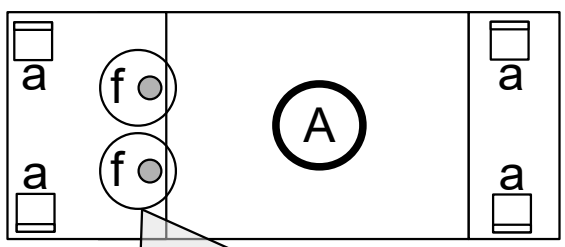
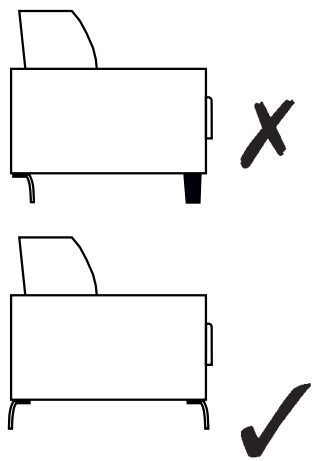
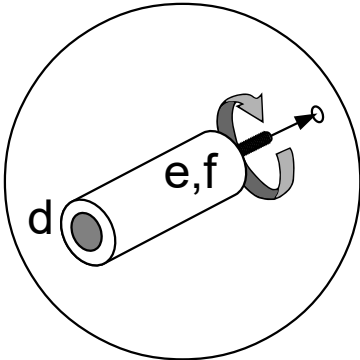
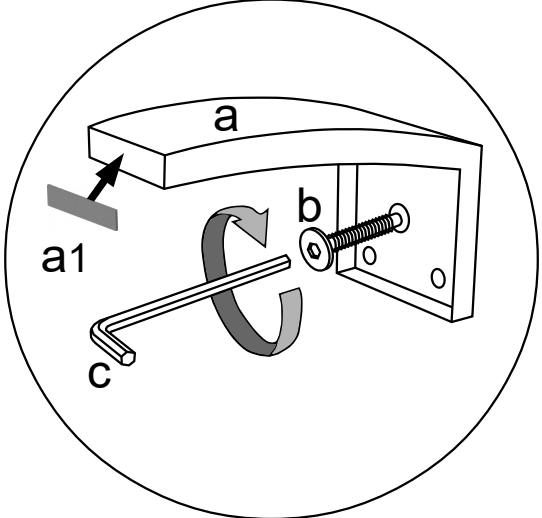
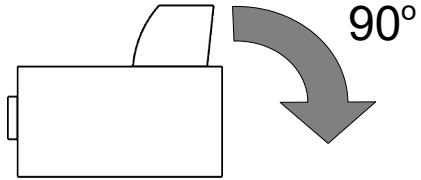

100/120mm

f

+

-

!

✓

X

0088

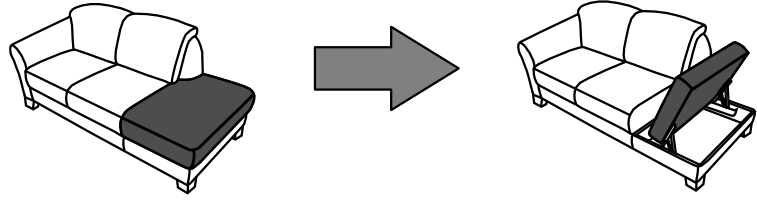

A B

