

*Madita*  
*Art. Nr. 2848150*  
1/6

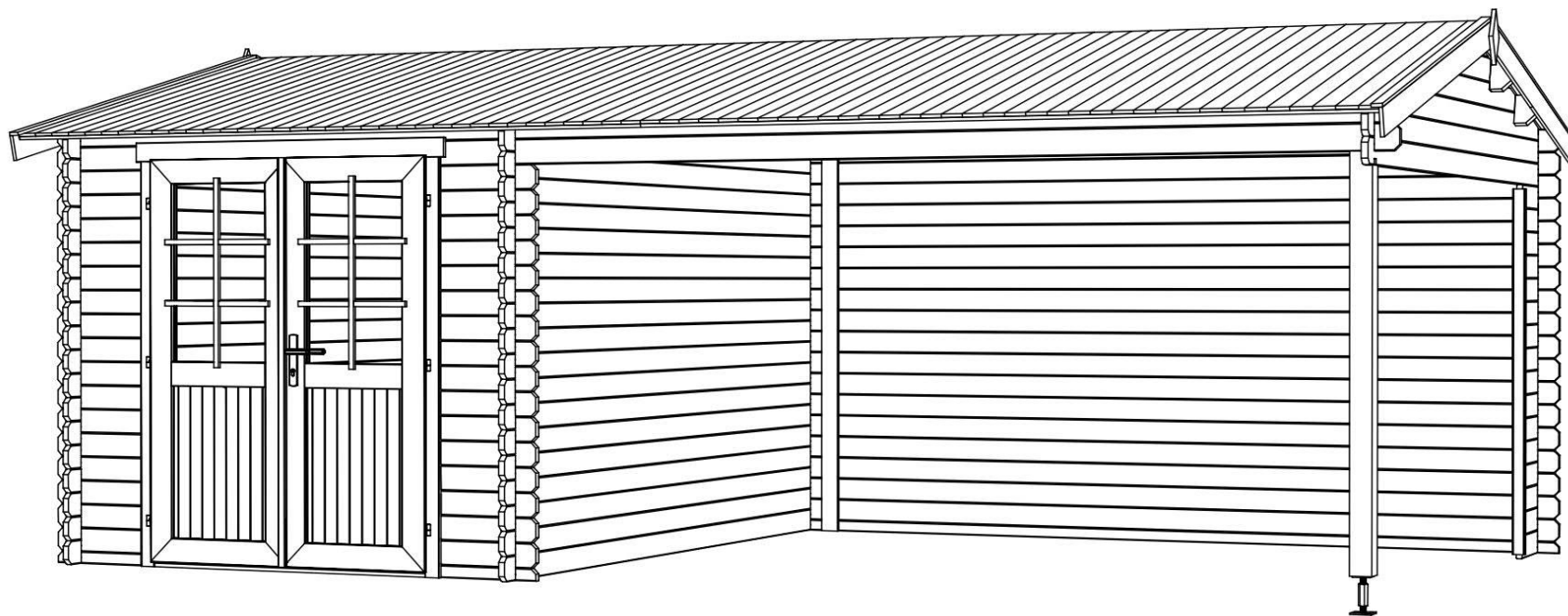

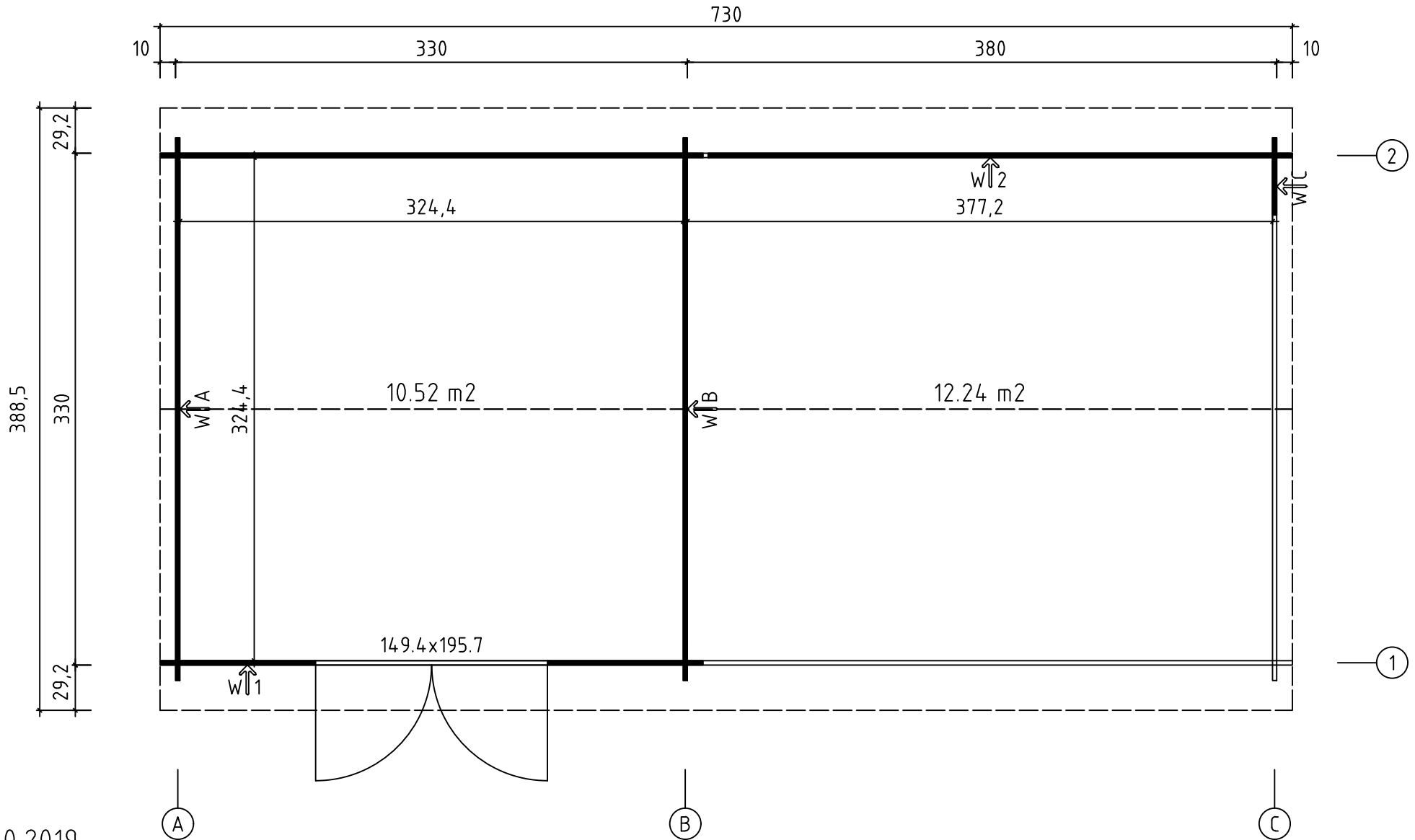





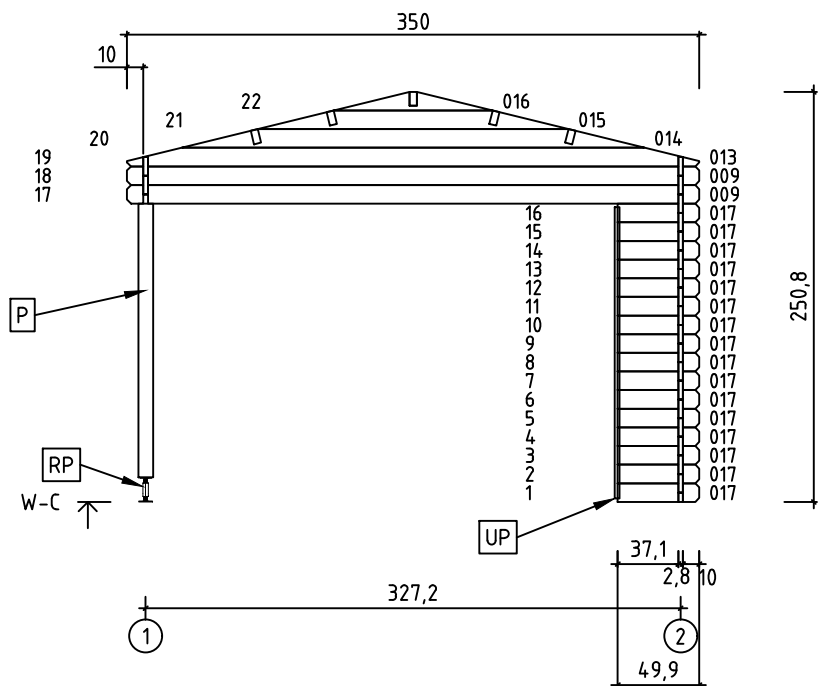
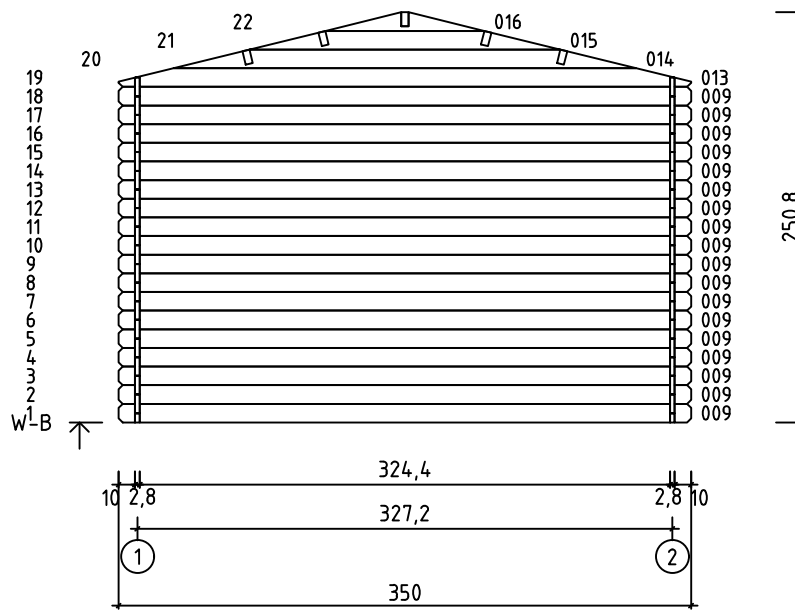
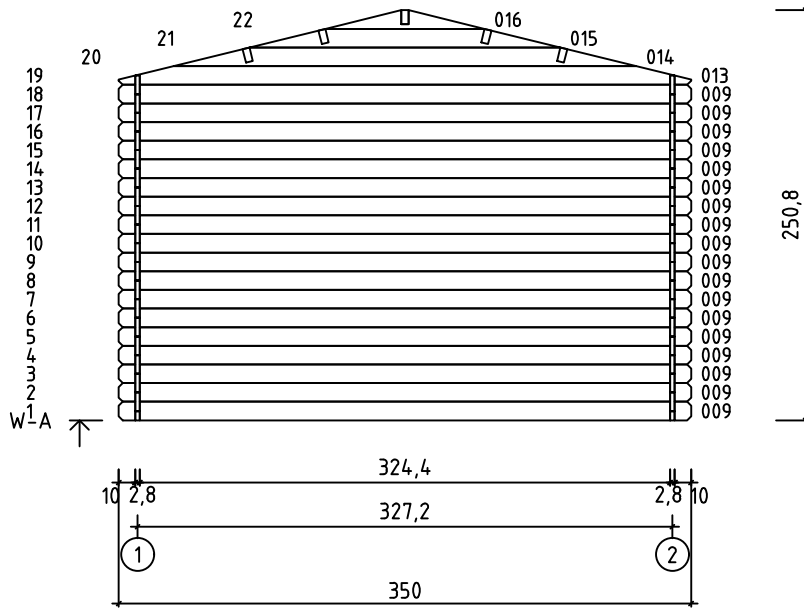

Art.Nr. 2848150

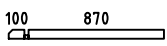
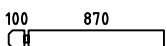
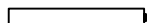
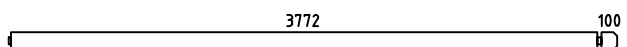
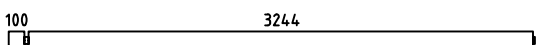
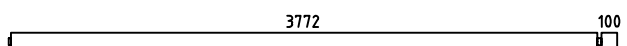
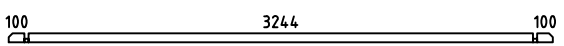
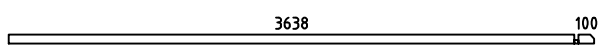
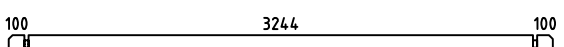
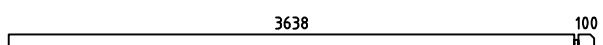
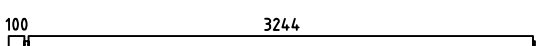
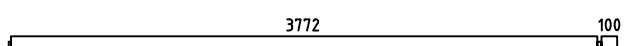

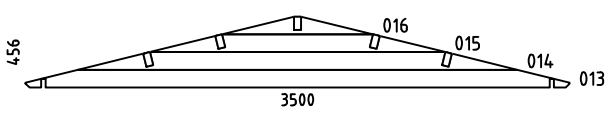
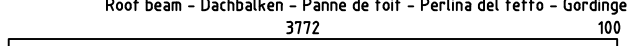
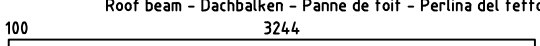
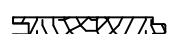

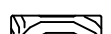

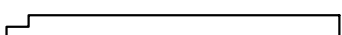





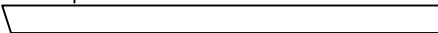
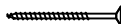
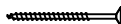
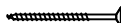





Groundplan - Grundplan - Plan de masse - Planimetria - Plattegrond - Põhiplaan





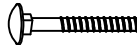





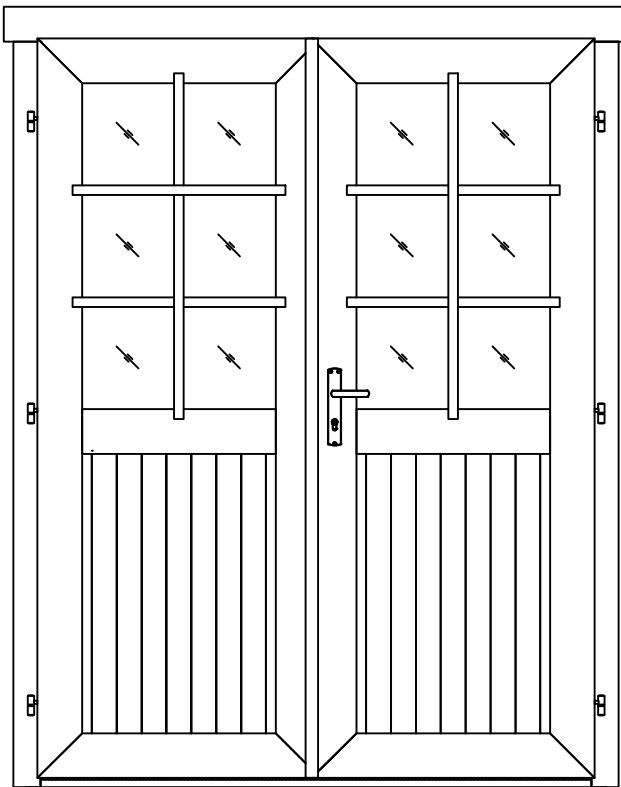
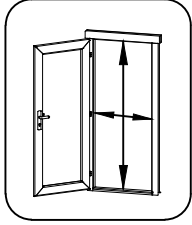
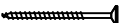
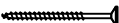
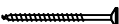

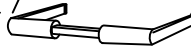
Pos	11.10.2019 Piece list - Stückliste - Liste des pièces - Elementi - Stuklijst - Tükítabel Art.Nr. 2848150	5/6	Q	P (mm)	L (mm)
001			2	28x57	998
002			33	28x114	998
003			1	28x114	884
004			1	28x114	3914
005			1	28x120	3386
006			1	28x120	3914
007			1	28x57	3500
008			1	28x57	3766
009			55	28x114	3500
010			17	28x114	3766
011			1	28x120	3386
012			1	28x120	3914
017			16	28x114	499
WA-1 WB-1 WC-1			1 1 1		
A-PR2	Roof beam - Dachbalken - Panne de toit - Perlina del tetto - Gordingen / dakbalk - Pärlin 		5	44x140	3914
A-PR1	Roof beam - Dachbalken - Panne de toit - Perlina del tetto - Gordingen / dakbalk - Pärlin 		5	44x140	3386
DB	Roof boards - Dachbretter - Voliges - Perlina per tetto - Dakhout - Katuselaud 		164	90x15	2000
HP	H-profile - H-profilis - Profile H - Profilo ad H - H-profiel - H-profiil 		1	58x90	2050
DPL	Roofing felt fillet - Dachpappenleiste - Baguette de fixation du feutre bitumeux - Asse per fissaggio guaina bituminosa - Afdeklijst asfaltpapier - Katusepapiilist 		4	15x45	2050
DPP-1	Roofing felt (strip) - Dachpappe (bahnen) - Feutre bitumeux (bande) - Cartone catramato - Asfaltpapier (baan) - Katusepapp 		5		7400
P	Post - Pfosten - Poteau - Piede registrabile - Stijl - Post 		1	90x90	1780
DRV-1	Roof edge reinforcement - Dachrandverstärkung - Corniere de renfort de bord de toit - Rinforzo x tetto - Dakrand versterking - Räästatugevdus 		4	15x45	3650

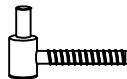
Pos	11.10.2019 Piece list - Stückliste - Liste des pièces - Elementi - Stuklijst - Tükítabel Art.Nr. 2848150 6/6	Q	P (mm)	L (mm)
KFS-1	Storm protection - Sturmleiste - Latte anti-tempete - Protezione anti vento - Stormverankering / beveiliging - Tormikinnusliist 	5	22x45	2500
UP	U-profile - U-profils - Profile u - Profilo ad u - U-profiel - U-profiil 	1	28x58	1780
GL	Gable moulding - Giebelleiste - Planche de rive - Finitura per frontale e retro del tetto - Gevellijst - Viilulaud 	4	15x120	2050
HS8	Screw for gable segment - Schrauben für deckblatt - Vis pour fixation losange de finition - Viti x frontali tetto - Schroef voor gevelpunt segment - Kruvi rombile 	4	3.5x35	
HS9	Screw for u-profile - Schraube zur befestigung u-profils - Vis a tete fraisée pour profil u - Vite per profilo ad u - Schroef ter bevestiging u-profiel - Kruvi U-profiilile 	6	3.5x50	
HS9	Screw for gable moulding - Schrauben für giebelleiste - Vis pour fixation planche de rive - Vite per fissare finiture davanti e dietro del tetto - Schroef voor gevellijst - Kruvi viilulauale 	32	3.5x50	
HS4	Screw for roof edge reinforcement - Schrauben für dachrandverstärkung - Vis pour fixation corniere renfort de bord de toit - Viti x rinforzo bordo tetto - Schroef voor dakrand versterking - Kruvi räästatugevdusele 	32	3x30	
HS14	Screw for post - Schrauben für pfosten - Vis de fixation des poteaux - Viti per inviare - Schroef voor stijlen - Kruvi postile 	2	4.5x80	
HS13	Screw for h-profile - Schraube zur befestigung h-profils - Vis a tete fraisée pour profil h - Vite per profilo ad h - Schroef ter bevestiging h-profiel - Kruvi H-profiilile 	1	4x60	
HS18	Screw for roof beams - Schrauben für dachbalken - Vis pour fixation pannes de toit - Viti per perline del tetto - Schroef voor gordingen / dakbalken - Kruvi pärlinitele 	20	5x120	
HS18	Screw for wall details - Schraube für wand details - Vis pour mur details - Viti per elementi della porta - Schroef voor wand details - Kruvi seinadetailile 	6	5x120	
HS18	Screw for gable - Schrauben für giebel - Vis pour fixation des pignons - Viti per timpano - Schroef voor gevelpunt - Kruvi viilude kinnitamiseks 	6	5x120	
HS20	Screw for post height adjustment - Schrauben für regulierungsschraube für pfosten - Vis de fixation de support réglable de poteau - Viti per fissare ed aggiustare l'altezza del palo verticale - Schroef voor hoogte instelling stijlen - Kruvi vajumispolidile 	8	6x50	
SH28	Hammer block - Schlagholz - Calle de frappe - Blocco di legno da usare come cuscinetto quando si usa il martello - Slagklos - Löögiklots 	1		
SFS	Nut for storm protection - Schraubenmutter für sturmleiste - Ecrou pour latte anti-tempete - Dado x asta protezione vento - Moer voor stormverankering - Mutter tormikinnusliistule 	10	D6	
NF4	Zn nail for roof - Zn nagel für dachbretter - Pointe pour fixation voliges de toit - Chiodi x perline tetto - Spijker(nagel) voor dakhout - Nael katuselauale 	682	2x50	
NF5	Zn nail for roofing felt fillet - Zn nagel für dachpappenleiste - Pointe pour baguette de fixation feutre bitumeux - Chiodi x carta bituminosa x tetto - Spijker(nagel) voor asfaltpapier afdekljst - Papiliistunael 	20	2x40	
NF6	Roofing nails for roofing felt - Nägel für dachpappe - Pointe pour fixation feutre bitumeux - Chiodi per cartone catramato - Asfaltnagel - Papinael 	300	2.8x15	
BFS	Bolt for storm protection - Bolzen für sturmleiste - Boulon pour latte anti-tempete - Bullone x asta protezione vento - Bout voor stormankerlat - Puidupolt tormikinnusliistule 	10	6x60	
GS	Gable segment - Deckblatt - Losange de finition - Decorazione in legno x frontale tetto - Gevelpunt segment - Romb 	2		
DFS	Washer for storm protection - Dichtscheibe für sturmleiste - Rondelle pour latte anti-tempete - Rondella x asta protezione vento - Afdichtring voor storm strip - Seib tormikinnusliistule 	10	D6	
RP	Post height adjustment - Pfostenträger verstellbar - Support réglable de poteau - Piede registrabile in altezza - Stelschroef voor stijlpost - Vajumispost 	1	D20	
	Door - Tür - Porte - Porte - Deur - Uks 1494x1957 TUK.2.056.SVP.MMb SGC	1		

Pos	13.01.2017	Piece list - Stückliste - Liste des pièces - Elementi - Stuklijst - Tükítabel 14.94x1957 TUK.2.056.SVP.MMb SGC	1/1	Q	P (mm)	L (mm)
		Glass size - Glasgröße - Taille de la vitre - Misura del vetro - Glas afmeting - Klaasi mõõt: 514x855 mm				
		 				
HS1	Screw for georgian bars - Schraube für sprossen - Vis pour croisillons - Viti per unire la griglia georgiana della finestra - Schroeven voor raamverdeling - Krugi ukse peffeliistule		12	2.5x20		
HS4	Screw for door fillet - Schraube zur befestigung türleiste - Vis pour fixation baguette d'arret de porte - Viti per massellino della porta - Schroef voor deurlijst - Krugi ukse kokkuvaltssiliistule		5	3x30		
HS16	Screw for door jamb - Schraube für türrahmen - Vis de fixation partie haute avec montants du cadre de porte - Viti x fissaggio montanti porte - Schroef voor deurkozijn - Krugi ukse lengile		4	5x90		
HS25	Screw for doorstep - Schrauben für swelle - Vis pour fixation barre de seuil - Vite per soglia della porta - Schroef voor deurdorpel - Krugi lävepakule		3	4.5x65		
TL4	Door handle fittings - Türgriff - Poignee de porte - Maniglie - Deurhendel / klink - Ukse käepide		1			
TL5	Set of door lock covers - Schlossblenden - Set de garnitures de porte - Copertura serrature - Slot sluitplaat set - Ukse lukuplaat		1			
	Cylinder lock - Zylinderschloss - Barillet de porte - Serratura - Cylinder slot - Ukse lukusüdamik		1	30x35		
	Male bolt hinge for door - Türband - Partie male de paumelle de porte - Cerniera anube x porta - Scharnier bout - Ukse polthing isane		6			
	Striker for barrel bolt - Hülse für grendelriegel - Gache au sol du targette - Boccola per fermo della porta - Huls voor vergrendelingsschuif - Vasturaud ukse servariivile		2			