

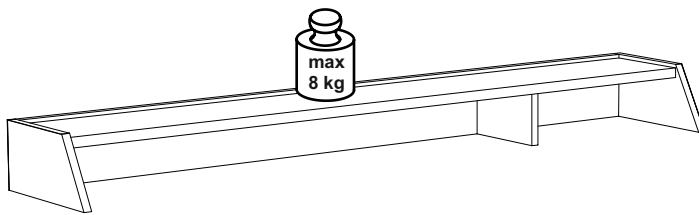

- |   |  |  |
|---|--|--|
| (D) Videounterstützte Montageanleitung            | (GB) Video-assisted assembly instructions            | (FR) Instructions de montage assistées par vidéo |
| (TR) Video destekli kurulum talimatları           | (IT) Istruzioni di montaggio video-assistite         | (NL) Video-ondersteunde montage-instructies      |
| (RU) инструкция по монтажу с помощью видеосигнала | (CZ) Instalační pokyny podporované videem            | (HU) Video-támogatott telepítési utasítások      |
| (RO) Instrucțiuni de instalare acceptate video    | (PL) Instrukcje montażu wspomagane sygnałem wizyjnym | (SK) Inštaláčné pokyny podporované videom        |

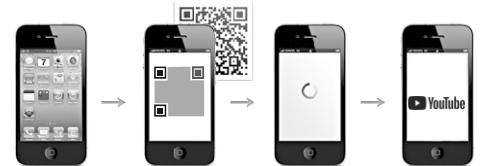

Art.-Nr.: **0215\_SA**

REPC-Nr.:

# Schreibtischaufsatz



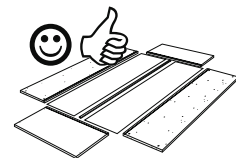
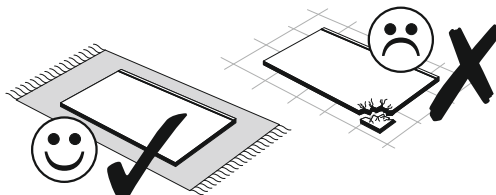
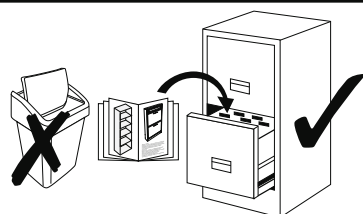
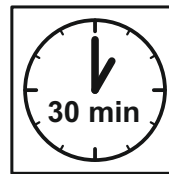
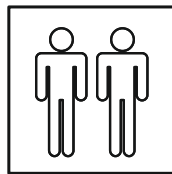
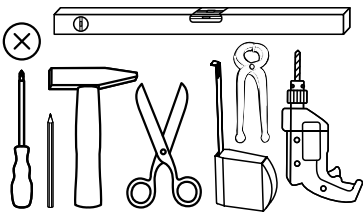



Service • Assistenza • Dienstverlening • Serwis  
Servis • Szerviz • Сервисная служба

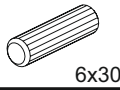

SCAN ME

Das Ersatzteil-Anforderungsformular finden Sie auf  
The replacement parts requisition form you find on  
<https://www.maeusbacher.de/ersatzteile/>

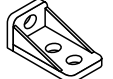
# BT1-00275 Colli 1/1

B02-90 2x	 6x30	B02-10 8x		B02-20 8x		
B05-130 1x		B03-134 6x		B02-133 1x		B01-122 2x
						 4x13



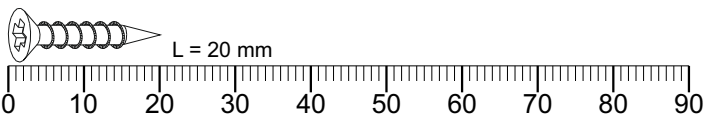

▶ SCAN ME

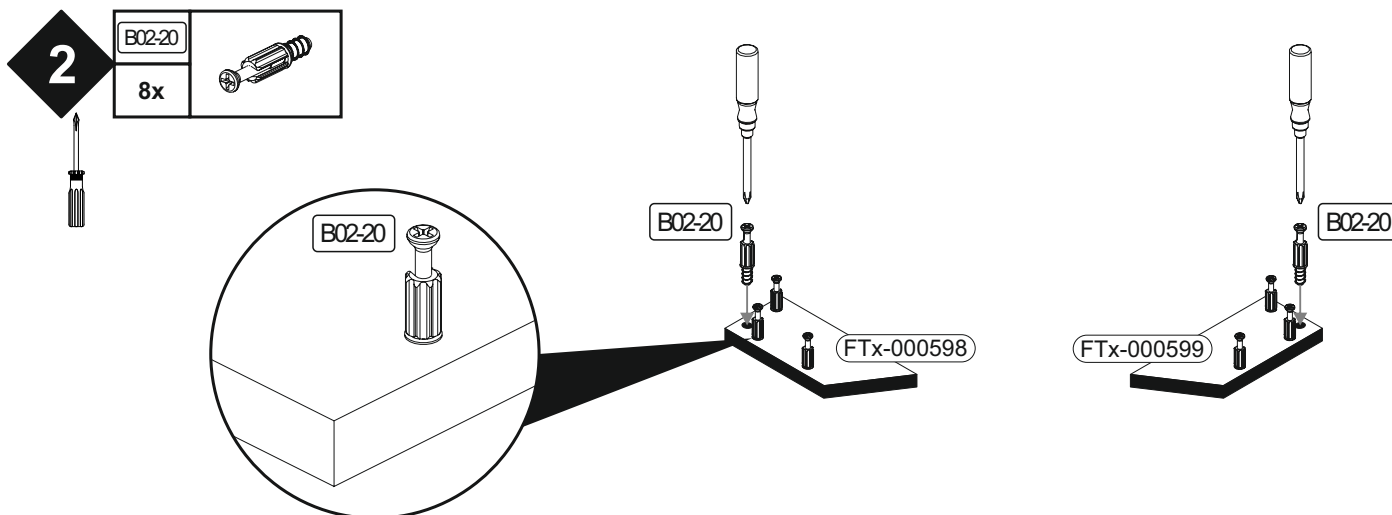
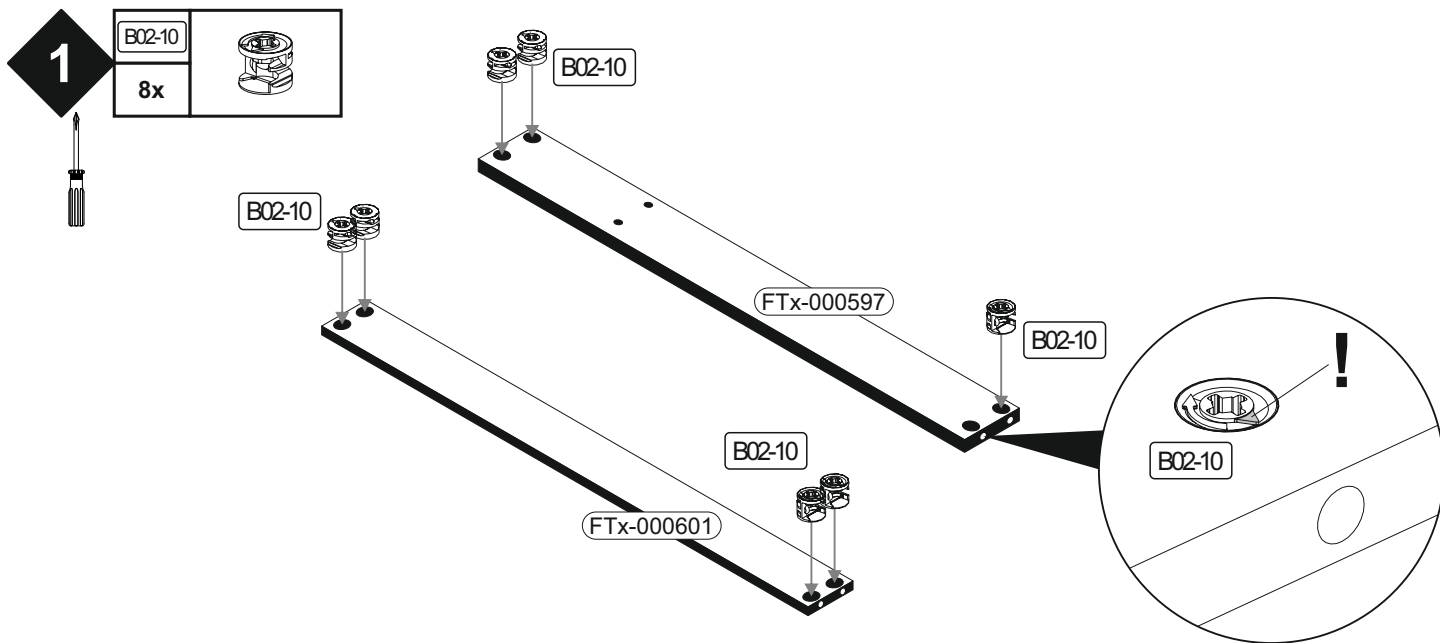
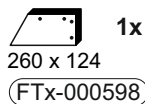
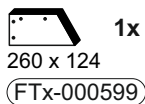
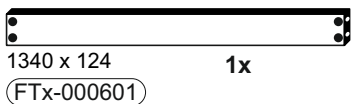
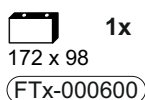
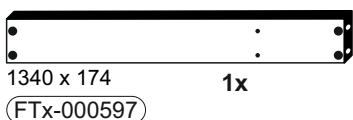

## Colli 1/1

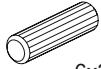

<b>3</b>	B02-90	
	2x	6x30
	B05-130	
	1x	

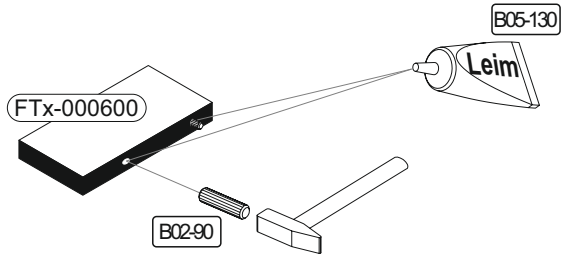
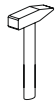

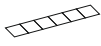
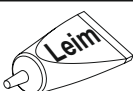
<b>4</b>	B03-134	
	2x	
	B05-130	
	1x	

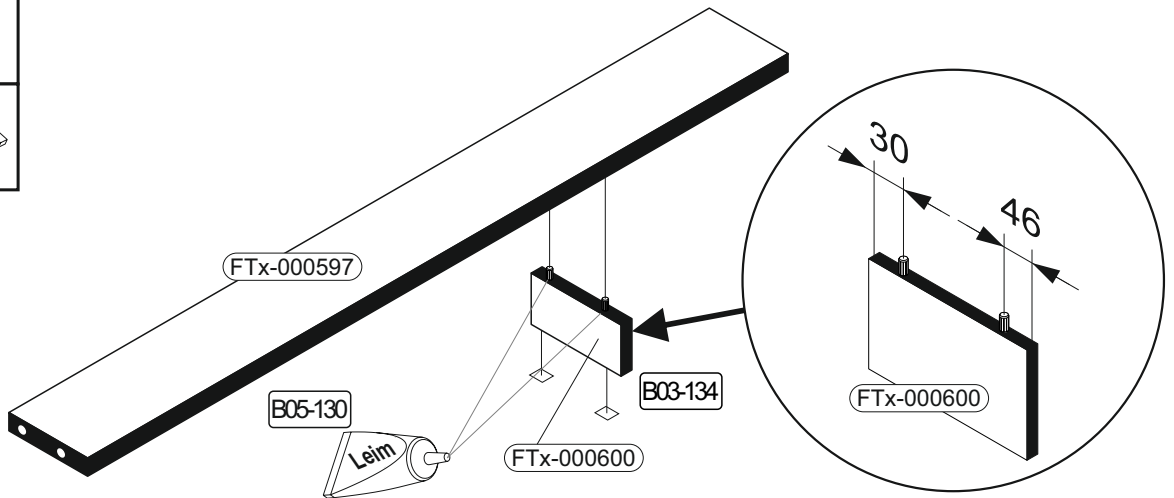

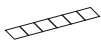
<b>5</b>	B03-134	
	4x	

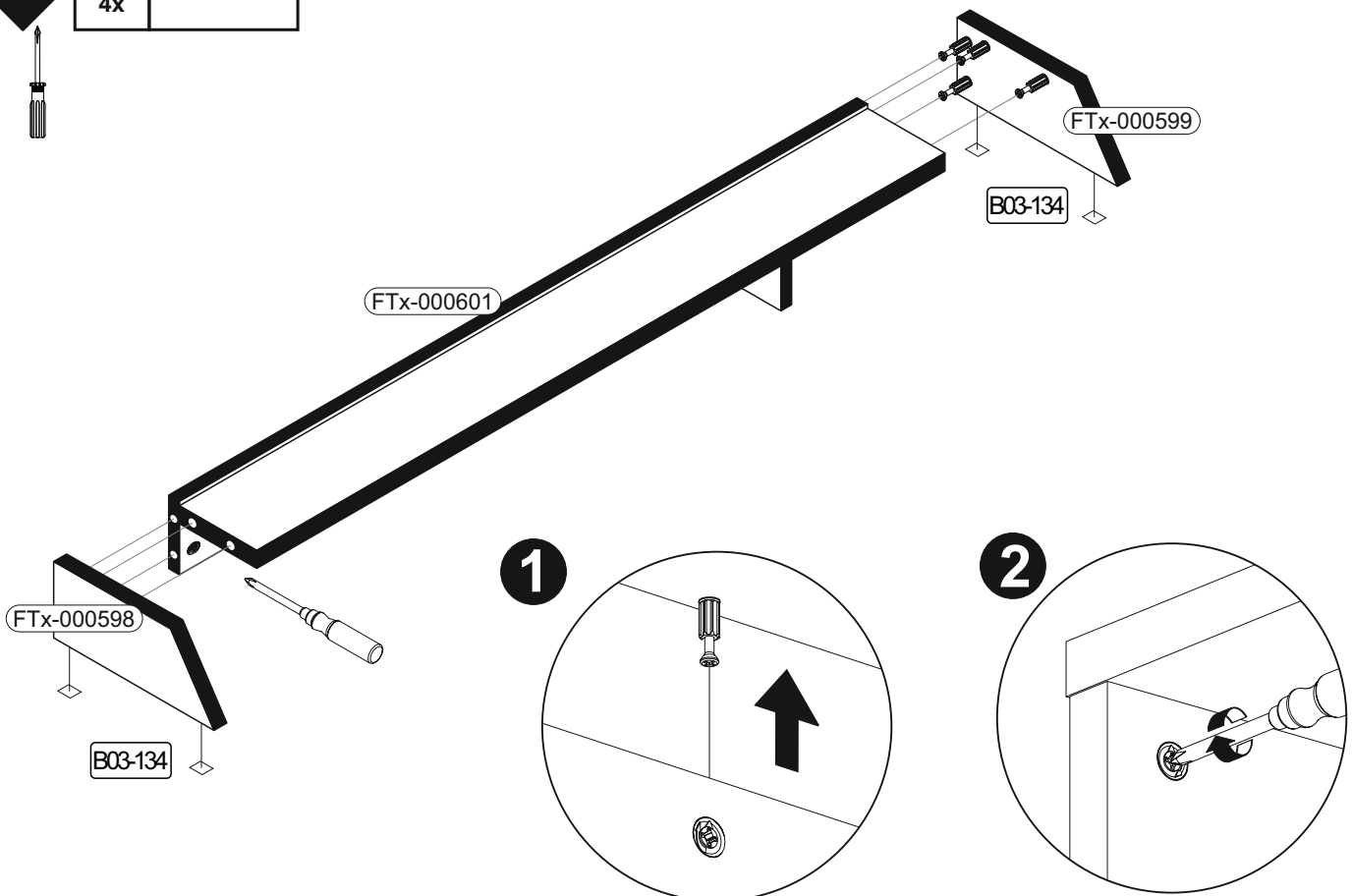

6



B02-133		B01-122	
1x		2x	4x13

