

KURZANLEITUNG



Die Sicherheitshinweise und Gebrauchsanleitung können auf unserer Internetseite docs.whirlpool.eu heruntergeladen werden, bitte die Anweisungen auf der Rückseite des Heftes befolgen.



Lesen Sie vor Inbetriebnahme des Geräts sorgfältig die Sicherheitshinweise.

PRODUKTBESCHREIBUNG

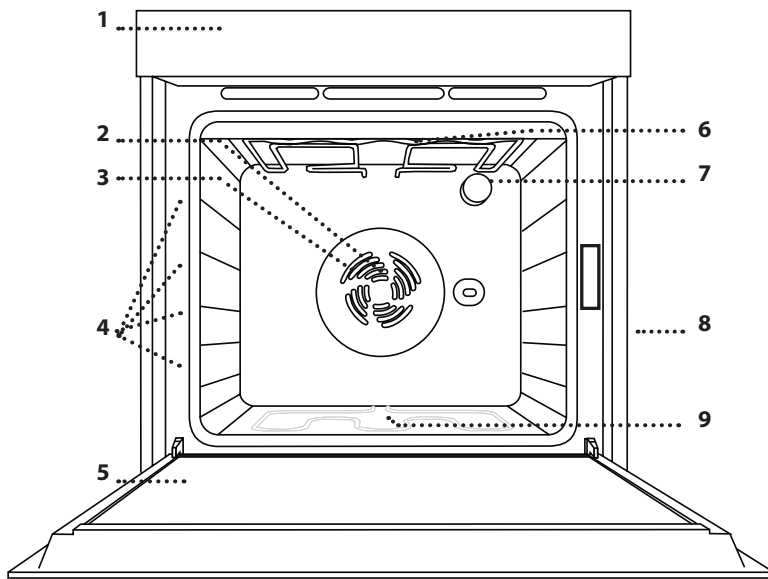

1. Bedienfeld
2. Gebläse
3. Ringheizelement (nicht sichtbar)
4. Seitengitter (die Einschubebene wird auf der Vorderseite des Ofens angezeigt)
5. Tür
6. Oberes Heizelement/Grill
7. Lampe
8. Typenschild (nicht entfernen)
9. Bodenheizelement (nicht sichtbar)

BEDIENTAFEL

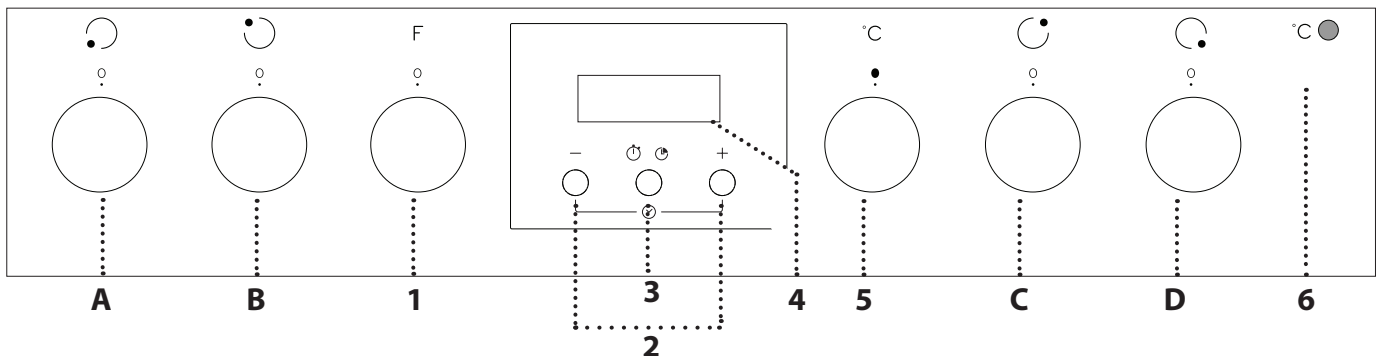

OFENBEDIENELEMENTE

1. AUSWAHLKNOPF

Zum Einschalten des Ofens durch Funktionsauswahl.
Auf **O** drehen, um den Ofen auszuschalten.

2. +/- TASTE

Zum Erhöhen oder Verringern des auf dem Display angezeigten Wertes.

3. ZEIT-TASTE

Zur Auswahl der verschiedenen Einstellungen: Dauer, Abschaltzeit, Timer.

4. DISPLAY

5. THERMOSTATREGLER

Drehen Sie den Regler zum Wählen der gewünschten Temperatur.

6. KONTROLLEUCHE THERMOSTAT/VORHEIZEN

Schaltet sich während dem

Heizvorgang an. Schaltet sich aus, wenn die gewünschte Temperatur erreicht ist.

BEDIENKNÖPFE DES KOCHFELDS

- A. Kochfeld vorne links.
- B. Kochfeld hinten links.
- C. Kochfeld hinten rechts.
- A. Kochfeld vorne rechts.

Bitte beachten: Alle Bedienknöpfe sind versenkbar. Drücken Sie den Bedienknopf mittig ein, um ihn aus der Versenkung zu holen.

ROST

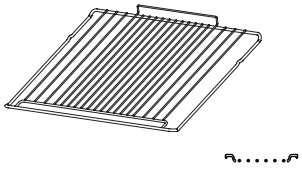

FETTPFANNE (WENN VORHANDEN)

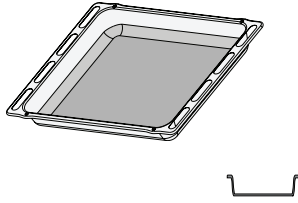

BACKBLECH

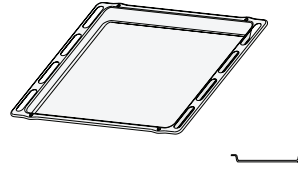

Die Anzahl und Art der Zubehörteile kann je nach gekauftem Modell variieren. Weitere Zubehörteile sind separat über den Kundenservice erhältlich.

DEN ROST UND ANDERE ZUBEHÖRTEILE EINSETZEN

- Den Rost horizontal einsetzen, indem dieser durch die Laufschielen geschoben wird; sicherstellen, dass die Seite mit dem erhöhten Rand nach oben zeigt.
- Andere Zubehörteile, wie Fettpfanne oder Backblech, werden auf die gleiche Weise horizontal eingesetzt wie der Rost.

ENTFERNEN UND ERNEUTES ANBRINGEN DER SEITENGITTER

- Zum Entfernen der Seitengitter die Befestigungsschrauben (sofern vorhanden) auf beiden Seiten mithilfe einer Münze oder eines Werkzeugs entfernen. Dann die Gitter anheben und deren untere Teile aus ihren Halterungen ziehen: Jetzt können die Seitengitter entfernt werden.
- Zum erneuten Anbringen der Seitengitter, diese wieder in ihrem oberen Sitz anbringen. Die Seitengitter halten, in den Garraum schieben und anschließend in die Position im unteren Sitz herablassen. Drehen Sie die Befestigungsschrauben wieder ein.

FUNKTIONEN

OFF
Zum Ausschalten des Ofens.

LAMPEN
Zum Ein-/Ausschalten der Ofenbeleuchtung.

OBER/UNTERHITZE
Zum Garen aller Arten von Gerichten auf einer Einschubebene.

HYDROCLEANING
Zum Entfernen der bei den Garvorgängen entstandenen Verschmutzung durch einen Zyklus bei niedriger Temperatur. Der Dampf, der durch dieses spezielle Reinigungsprogramm bei niedriger Temperatur entsteht, ermöglicht das einfache Entfernen von Schmutz und Speiseresten. 200 ml Trinkwasser auf den Ofenboden geben und die Funktion 35 Minuten bei 90°C verwenden. Die Funktion aktivieren, wenn der Ofen kalt ist und ihn für 15' abkühlen lassen.

UMLUFT
Zum Garen von Fleisch und Backen von salzigen oder süßen Kuchen mit flüssiger Füllung auf einer Ebene sowie Pizza auf einer oder zwei Ebenen. Zum Garen auf zwei Ebenen. Für ein gleichmäßigeres Ergebnis tauschen Sie die Position der Speisen nach halber Garzeit.

GRILL
Zum Grillen von Steaks, Grillspießen und Bratwürsten, zum Überbacken von Gemüse oder Rösten von Brot. Beim Grillen von Fleisch wird die Verwendung eines Backblechs zum Aufsammeln der Garflüssigkeiten empfohlen: Die Fettpfanne unter eine beliebige Einschubebene unter den Rost stellen und 500 ml Trinkwasser zufügen.

GRATIN
Zum Garen großer Fleischstücke (Keulen, Roastbeef, Hähnchen). Es wird die Verwendung eines Backblechs zum Aufsammeln der Garflüssigkeiten empfohlen: Die Fettpfanne unter eine beliebige Einschubebene unter den Rost stellen und 500 ml Trinkwasser zufügen. Der Drehspieß (falls vorhanden) kann mit dieser Funktion verwendet werden.

AUFTAUEN
Zur Beschleunigung des Auftauens von Speisen.

TURBOGEBLÄSE
Zum Backen von Speisen mit knusprigem Boden und weicher Oberfläche. Ideal zum Backen von Kuchen mit flüssiger Füllung und ohne vorgebackene Masse auf einer Einschubebene. Diese Funktion eignet sich auch zum Garen von Tiefkühlfertigkost.

MEHRERE EINSCHUBEBENEN
Zum gleichzeitigen Garen verschiedener Speisen bei gleicher Temperatur auf zwei Einschubebenen. Die Funktion erlaubt das Garen ohne Geschmacksübertragung von einer Speise auf die anderen.

UNTEN
Zum Anbräunen der Unterseite der Speise. Die Funktion kann auch zum Schmoren, zum Fertigkochen von sehr flüssigen Speisen (süß oder sauer) oder zum Verdicken von Saucen und Bratensaft verwendet werden.

ERSTE INBETRIEBNAHME DES GERÄTS

1. EINSTELLEN DER UHRZEIT

Wenn den Ofen zum ersten Mal eingeschaltet wird, muss die Zeit eingestellt werden: „AUTO“ und „0.00“ blinken auf dem Display.



Um die Uhrzeit einzustellen, drücken Sie die Tasten – und + gleichzeitig: Stellen Sie die Uhrzeit mit den Tasten + und – ein.

Bitte beachten: Um die Tageszeit im Nachhinein zu ändern, zum Beispiel nach einem längeren Stromausfall, müssen Sie die Zeit zurückstellen

2. EINSTELLEN DES TONS

Nach Auswahl der gewünschten Zeit, die *Zeit-Taste* drücken: Auf dem Display wird „ton 1“ angezeigt.



Um den gewünschten Ton auszuwählen, die Taste – drücken, dann die *Zeit-Taste* zur Bestätigung.

3. AUFHEIZEN DES OFENS

Ein neuer Ofen kann Gerüche freisetzen, die bei der Herstellung zurückgeblieben sind: Das ist ganz normal. Vor dem Garen von Speisen wird daher empfohlen, den Ofen in leerem Zustand aufzuheizen, um mögliche Gerüche zu entfernen.

Schutzkarton und Klarsichtfolie aus dem Ofen entfernen und die Zubehörteile entnehmen. Den Ofen für ungefähr eine Stunde auf 250 °C bevorzugt mit der „Umluft“-Funktion aufheizen. Der Ofen muss während dieser Zeit leer sein.

Die Anweisungen zur korrekten Einstellung der Funktion befolgen.

Bitte beachten: Es wird empfohlen, den Raum nach dem ersten Gebrauch des Geräts zu lüften.

TÄGLICHER GEBRAUCH

1. AUSWÄHLEN EINER FUNKTION

Um eine Funktion auszuwählen, den *Auswahlknopf* auf das Symbol für die gewünschte Funktion drehen.

2. EINE FUNKTION AKTIVIEREN

Um die Funktion zu aktivieren, müssen Sie den *Thermostatregler* auf die gewünschte Temperatur drehen.

Um die Funktion jederzeit zu unterbrechen, den Ofen ausschalten, den *Auswahlknopf* und den *Thermostatregler* auf 0 und ● drehen.

3. VORHEIZEN

Sobald die Funktion aktiviert wurde, schaltet sich die Kontrollleuchte des Thermostat ein und signalisiert, dass das Vorheizen begonnen hat.

Am Ende dieses Vorgangs, schaltet sich die Kontrollleuchte des Thermostats aus und gibt an, dass der Ofen die eingestellte Temperatur erreicht hat: An diesem Punkt die Speise in den Ofen stellen und den Garvorgang fortsetzen.

Bitte beachten: Wird die Speise in den Ofen gestellt, bevor das Vorheizen beendet ist, kann dies negative Auswirkungen auf das endgültige Garergebnis haben.

. PROGRAMMIERTES GAREN

Nach Auswahl und Aktivierung der Funktion kann die Dauer eingestellt werden.



DAUER

Die *Zeit-Taste* drücken: Das Symbol 🔔 blinkt.



Die *Zeit-Taste* erneut drücken: Auf dem Display wird „DUR“ angezeigt und „AUTO“ blinkt.

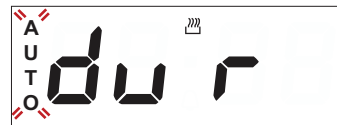

Die Dauer mit den Tasten + und – einstellen. Nach einigen Sekunden wird auf dem Display die Tageszeit angezeigt während AUTO zur Bestätigung der Einstellung weiterhin aufleuchtet.



Um die restliche Garzeit anzuzeigen, die *Zeit-Taste* mindestens 2 Sekunden lang drücken. Um sie bei Bedarf zu ändern, die Taste erneut drücken und mit den Tasten + und – die Dauer verändern.

Nach Ablauf der Garzeit, schaltet das Symbol 🔔 ab, ein Alarm ertönt und **AUTO** blinkt auf dem Display.



Drücken Sie zur Deaktivierung des Alarms eine beliebige Taste.

Drehen Sie den Funktionsknopf und *Thermostatregler* zurück auf 0 und ●, drücken Sie dann die *Zeit-Taste* mindestens 2 Sekunden lang, um den Ofen auszuschalten.

TIMER EINSTELLEN

Diese Option unterbricht oder aktiviert nicht das Garen, aber ermöglicht es Ihnen die Anzeige als Timer zu verwenden, sowohl wenn eine Funktion aktiviert ist als auch bei ausgeschaltetem Ofen.

Um den Timer zu aktivieren, die *Zeit-Taste* lang drücken: das Symbol  blinkt auf dem Display.



Die gewünschte Dauer mit den Tasten + und – einstellen: Der Countdown beginnt nach einigen Sekunden.



Auf dem Display wird die Tageszeit angezeigt und  leuchtet weiterhin auf und bestätigt damit, dass der Timer eingestellt wurde.

Bitte beachten: Wenn Sie die Timereinstellung ansehen und ggf. ändern möchten, drücken Sie erneut die *Zeit-Taste* 2 Sekunden lang.

BETRIEB DES KOCHFELDS

(siehe Bedienungsanleitung des Kochfelds).

Drehen Sie den Bedienknopf der zugehörigen Kochzone im Uhrzeigersinn auf die gewünschte Position.

Das Bedienfeld des Backofens verfügt über 4 Bedienknöpfe, mit denen das Kochfeld bedient wird. Die Bedienknöpfe sind mit einer Strichskala entsprechend den verschiedenen Leistungstufen und verschiedenen Funktionssymbolen versehen.

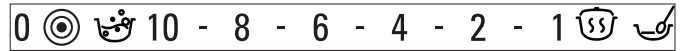

SCHMELZSTUFE

Zum Aufgehen von Teig, Aufweichen von gekühlter Butter, Warmhalten von Milch in der Trinkflasche oder von Babynahrung, zur Herstellung von Joghurt, zum Schmelzen von Schokolade, usw. Diese Betriebsart funktioniert nur bei leuchtender Restwärme-Kontrollleuchte. Achten Sie darauf, dass die Restwärme-Kontrollleuchte der Kochzone leuchtet, die Sie verwenden möchten. Drehen Sie den Bedienknopf auf . Zum Abschalten der Funktion brauchen Sie nur die Position des Bedienknopfs zu ändern.



WARMHALTEN

Zur Beibehaltung einer gleichbleibenden Temperatur von 60 °C im Backofen. Zum Auswählen dieser Funktion drehen Sie den Bedienknopf auf .

TURBOSTUFE

Mit dieser Funktion kann Wasser schneller zum Sieden gebracht werden. Sie bleibt für eine vorgegebene Zeit eingeschaltet. Nach Ablauf dieser Zeit schaltet die Kochzone automatisch zur höchsten Leistungsstufe zurück. Die Funktion kann auch während eines Garvorgangs zugeschaltet werden. Wichtig: Stellen Sie vor dem Einschalten dieser Funktion einen Topf auf die entsprechende Kochzone, um die Oberfläche des Kochfelds nicht zu beschädigen. Die für diese Funktion angegebenen Leistungswerte werden für alle Glaskeramik-Kochfelder garantiert. Um die Funktion zu wählen, stellen Sie einen Topf auf die gewählte Kochzone, und drehen Sie den Bedienknopf auf . Zum Abschalten der Funktion brauchen Sie nur die Position des Bedienknopfs zu ändern.

MULTIZONE

Diese Funktion ist für das vordere linke und hintere rechte Kochfeld zuschaltbar. Sie vergrößert den Heizbereich für besonders große, ovale oder rechteckige Töpfe. Zuschalten: Drehen Sie den Bedienknopf auf  und warten Sie, bis die entsprechende Restwärme-Kontrollleuchte blinkt. Zum Einschalten der dreifachen Kochzone (falls vorhanden) warten Sie, bis die Kontrollleuchte schneller blinkt. Dann stellen Sie die gewünschte Leistungsstufe durch Drehen des Bedienknopfes gegen den Uhrzeigersinn ein. Die Restwärme-Kontrollleuchte leuchtet weiterhin, um anzuzeigen, dass das Kochfeld eingeschaltet ist. Zum Ausschalten den Bedienknopf auf  drehen.

Bitte beachten: Die Funktion „Multizone“ lässt sich nur bei den doppelten oder dreifachen Kochzonen des Kochfelds verwenden

GARTABELLE

REZEPT	FUNKTION	VORHEIZEN	TEMPERATUR (°C)	DAUER (MIN)	EINSCHUBEBENE UND ZUBEHÖRTEILE
Hefekuchen		Ja	160 - 180	35 - 55	2
		Ja	150 - 170	30 - 90	3 1
Gefüllter Kuchen (Käsekuchen, Strudel, Apfelmuchen)		Ja	150 - 190	30 - 85	2
		Ja	150 - 190	35 - 90	3 1
Plätzchen / Törtchen		Ja	170 - 180	15 - 40	3
		Ja	150 - 175	20 - 45	3 1
Beignets		Ja	180	30 - 40	3
		Ja	170 - 190	35 - 45	3 1
Meringue		Ja	90	120 - 130	3
		Ja	90	130 - 150	3 1
Brot / Pizza / Fladenbrot		Ja	190 - 250	15 - 50	2
		Ja	190 - 250	25 - 50	3 1
Tiefkühlpizza		Ja	250	10 - 15	2
		Ja	250	10 - 20	3 1
Herzhaftes Gebäck (Gemüsetorte, Quiche)		Ja	175 - 200	40 - 50	2
		Ja	175 - 190	50 - 65	3 1
Blätterteigtörtchen / Herzhaftes Blätterteiggebäck		Ja	180 - 200	20 - 30	3
		Ja	175 - 200	25 - 45	3 1
Lasagne / überbackene Pasta / Cannelloni / Aufläufe		Ja	190 - 200	40 - 65	2
Lamm, Kalb, Rind, Schwein 1 kg		Ja	190 - 200	90 - 110	2
Hähnchen / Kaninchen / Ente 1 kg		Ja	190 - 200	65 - 85	2
Truthahn / Gans 3 kg		Ja	190 - 200	140 - 180	1/2
Lamm/Kalb/ Rind/Schwein 1 kg		Ja	180 - 200	40 - 60	2
Schweinebraten mit Kruste 2 kg		Ja	175 - 200	50 - 60	2
Hähnchen/Kaninchen/Ente 1 kg		Ja	200	2 - 5	4

FUNKTIONEN					
	Ober-/Unterhitze	Grill	Gratiniert	Heißluft	Umluft

ZUBEHÖRTEILE					
	Ofenrost	Kuchenform auf Rost	Fettpfanne / Backblech oder Kuchenform auf Rost	Fettpfanne / Backblech	Fettpfanne mit 500 ml Wasser

REZEPT	FUNKTION	VORHEIZEN	TEMPERATUR (°C)	DAUER (MIN)	EINSCHUBEBENE UND ZUBEHÖRTEILE
Puter/Gans 3 kg		Ja	190 - 200	140 - 180	4 3
Fisch gebacken/in Folie (Filets, ganz)		Ja	180 - 200	40 - 60	2
Gefülltes Gemüse (Tomaten, Zucchini, Auberginen)		Ja	175 - 200	50 - 60	2
Toast		Ja	200	2 - 5	4
Fischfilets/Steaks		Ja	200	30 - 40 *	4 3
Wurstchen/Fleischspieße/ Rippchen/Hamburger		Ja	200	30 - 50 *	4 3
Brathähnchen 1-1,3 Kg		-	200	55 - 70 *	2 1
Roastbeef englisch 1 kg		-	200	35 - 50 **	2
Lammkeule / Schweinshaxe		-	200	60 - 90 **	2
Bratkartoffeln		-	200	45 - 55 **	2
Gemüsegratin		-	200	20 - 30	2
Lasagne, Fleisch		Ja	200	50 - 100 ***	3 1
Fleisch & Kartoffeln		Ja	200	45 - 100 ***	3 1
Fisch & Gemüse		Ja	175	30 - 50 ***	3 1

* Das Gargut nach halber Garzeit wenden.

** Das Gargut nach zwei Dritteln der Garzeit wenden (bei Bedarf).

*** Vertauschen Sie die Einschubebenen nach halber Garzeit.

**** Voraussichtliche Zeitdauer: Je nach persönlichen Vorlieben können die Speisen zu verschiedenen Zeitpunkten aus dem Ofen genommen werden.

Die Gebrauchsanleitung mit der Tabelle der erprobten Rezepte, die für die Zertifizierungsstellen in Übereinstimmung mit der IEC-Norm IEC 60350-1 zusammengestellt wurden, auf docs.indesit.eu herunterladen.

FUNKTIONEN	 Ober-/Unterhitze	 Grill	 Gratinert	 Heißluft	 Umluft
ZUBEHÖRTEILE	 Ofenrost	 Kuchenform auf Rost	 Fettpfanne / Backblech oder Kuchenform auf Rost	 Fettpfanne / Backblech	 Fettpfanne mit 500 ml Wasser

WARTUNG UND REINIGUNG



Für weitere Informationen die Gebrauchsanleitung auf docs.whirlpool.eu runterladen

Vor dem Ausführen beliebiger Wartungs- oder Reinigungsarbeiten sicherstellen, dass der Ofen abgekühlt ist.

Verwenden Sie keine Dampfreiniger.

Keine Stahlwolle, Scheuermittel oder aggressive/ätzende Reinigungsmittel verwenden, da diese die Flächen des Gerätes beschädigen können.

Schutzhandschuhe tragen.

Vor dem Ausführen beliebiger Wartungsarbeiten muss der Ofen von der Stromversorgung getrennt sein.

AUSSENFLÄCHEN

Reinigen Sie die Flächen mit einem feuchten Mikrofasertuch.

Sollten sie stark verschmutzt sein, einige Tropfen von pH-neutralem Reinigungsmittel verwenden. Reiben Sie mit einem trockenen Tuch nach.

Keine aggressiven Reinigungs- oder Scheuermittel verwenden. Falls ein solches Mittel versehentlich mit den Flächen des Geräts in Kontakt kommt, dieses sofort mit einem feuchten Mikrofasertuch reinigen.

INNENFLÄCHEN

• Den Ofen nach jedem Gebrauch abkühlen lassen und anschließend reinigen, vorzugsweise wenn dieser noch warm ist, um durch Speiserückstände verursachte Ablagerungen oder Flecken zu entfernen.

Zum Trocknen von Kondensation, die sich beim Garen von Speisen mit einem hohen Wassergehalt bildet, den Ofen vollständig abkühlen lassen und anschließend mit einem Tuch oder Schwamm trockenwischen. Das Glas der Backofentür mit einem geeigneten Flüssigreiniger reinigen

- Die Backofentür kann zum Reinigen vollständig ausgehängt werden .

ZUBEHÖRTEILE

Die Zubehörteile nach dem Gebrauch in Geschirrspülmittellauge einweichen, Backofenhandschuhe verwenden, solange die Zubehörteile noch heiß sind. Speiserückstände können dann mit einer Spülbürste oder einem Schwamm entfernt werden.

AUSWECHSELN DER LAMPE

1. Trennen Sie den Ofen von der Stromversorgung.
2. Die Abdeckung von der Beleuchtung abschrauben, die Lampe ersetzen und die Abdeckung erneut an der Beleuchtung festschrauben.
3. Schließen Sie den Ofen wieder an das Stromnetz an.

Bitte beachten: Verwenden Sie nur Glühlampen mit 25-40 W/230 V Typ E-14, T 300°C oder Halogenlampen mit 20-40 W/230 V Typ G9, T 300° C. Die im Gerät verwendete Lampe ist speziell für Elektrogeräte konzipiert und ist nicht für die Beleuchtung von Räumen geeignet (EU-Verordnung 244/2009). Die Glühlampen sind über unseren Kundendienst erhältlich.

-Bei der Verwendung von Halogenlampen, diese nicht mit bloßen Händen berühren, da sie durch die Fingerabdrücke beschädigt werden könnten. Den Backofen erst benutzen, nachdem die Abdeckung der Beleuchtung wieder aufgesetzt wurde.

AUSBAU UND ERNEUTES ANBRINGEN DER TÜR

1. Zur Entfernung der Tür, diese vollständig öffnen und die Haken senken, bis sie sich in entriegelter Position befinden.

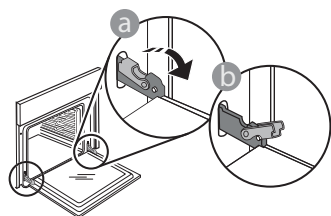

2. Die Tür so weit wie möglich schließen. Die Tür mit beiden Hände festhalten – diese nicht am Griff festhalten. Die Tür einfach entfernen, indem sie weiter geschlossen und gleichzeitig nach oben gezogen wird, bis sie sich aus ihrem Sitz löst. Die Tür seitlich abstellen und auf eine weiche Oberfläche legen. Die Tür seitlich abstellen und auf eine weiche Oberfläche legen.

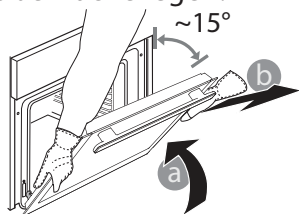

3. Die Tür erneut anbringen, indem sie zum Ofen geschoben wird und die Haken der Scharniere auf ihre Sitze ausgerichtet werden, den oberen Teil auf seinem Sitz sichern.

4. Die Tür senken und anschließend vollständig öffnen. Die Haken in ihre Ausgangsposition senken: Sicherstellen, dass die Haken vollständig gesenkt werden.

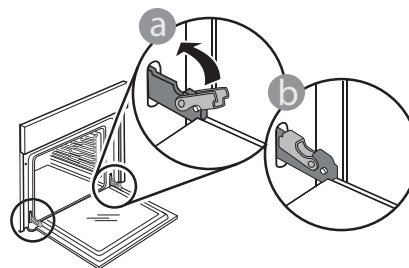

Einen leichten Druck ausüben, um zu überprüfen, dass sich die Haken in der korrekten Position befinden.

5. Versuchen, die Tür zu schließen und sicherstellen, dass sie auf das Bedienfeld ausgerichtet ist. Ist dies nicht der Fall, die oben aufgeführten Schritte wiederholen: Die Tür könnte beschädigt werden, wenn dies nicht richtig funktioniert.

Problem	Mögliche Ursache	Abhilfemaßnahme
Der Ofen funktioniert nicht.	Stromausfall. Trennung von der Stromversorgung.	Überprüfen, ob das Stromnetz Strom führt und der Backofen an das Netz angeschlossen ist. Schalten Sie den Backofen aus und wieder ein, um festzustellen, ob die Störung erneut auftritt.
Das Display zeigt ein „F“ gefolgt von einer Nummer an.	Softwareproblem.	Das nächste Kundendienstzentrum kontaktieren und die Nummer angeben, die dem Buchstaben „F“ folgt.

HILFREICHE TIPPS



Für weitere Informationen die Gebrauchsanleitung auf docs.whirlpool.eu runterladen

LESEN DER GARTABELLE

Die Tabelle listet die besten Funktionen, Zubehörteile und Einschubebenen auf, die für die verschiedenen Arten von Speisen zu verwenden sind. Die Garzeiten gelten ab dem Moment, in dem Sie das Gargut in den Ofen geben, die (eventuell erforderliche) Vorheizzeit zählt nicht dazu. Die Gartemperaturen und -zeiten sind nur Richtwerte und sind von der Menge des Garguts und von den verwendeten Zubehörteilen abhängig. Zunächst die niedrigeren Einstellungen verwenden und, falls das erzielte Garergebnis nicht den Wünschen entspricht, zu den höheren Einstellungen übergehen. Es wird empfohlen, die mitgelieferten Zubehörteile und vorzugsweise Kuchenformen und Backbleche aus dunklem Metall zu verwenden. Es können auch Töpfe und Zubehörteile aus feuerfestem Glas oder Keramik verwendet werden, aber es ist zu berücksichtigen, dass sich die Garzeiten dadurch etwas verlängern

GLEICHZEITIGES GAREN VERSCHIEDENER SPEISEN

Bei der Verwendung der Funktion „Heißluft“ lassen sich verschiedene Speisen, welche die gleiche Gartemperatur erfordern (z. B.: Fisch und Gemüse) auf verschiedenen Einschubebenen gleichzeitig garen. Die Speise mit kürzerer Garzeit aus dem Ofen nehmen und die Speisen mit längerer Garzeit weiterhin im Ofen lassen.

TECHNISCHE DATEN

Die technischen Daten mit Angabe der Energiedaten für dieses Gerät können auf der Internetseite docs.whirlpool.eu runtergeladen werden

WIE IST DIE GEBRAUCHSANLEITUNG ERHÄLTlich?

> Die Gebrauchsanleitung von unserer Internetseite docs.whirlpool.eu runterladen (es kann der QR-Code verwendet werden), dabei den Produkthandelscode angeben.



> Alternativ unseren Kundendienst kontaktieren.

UNSEREN KUNDENDIENST KONTAKTIEREN

Unsere Kontaktdaten sind im Garantiehandbuch zu finden. Wird der Kundendienst kontaktiert, bitte die Codes auf dem Typenschild des Produkts angeben.

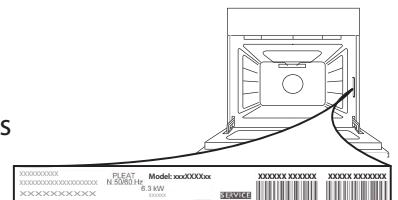

DAILY REFERENCE GUIDE



You can download the Safety Instructions and the Use and Care Guide by visiting our website docs.whirlpool.eu and following the instructions on the back of this booklet.



Before using the appliance carefully read the Health and Safety guide.

PRODUCT DESCRIPTION

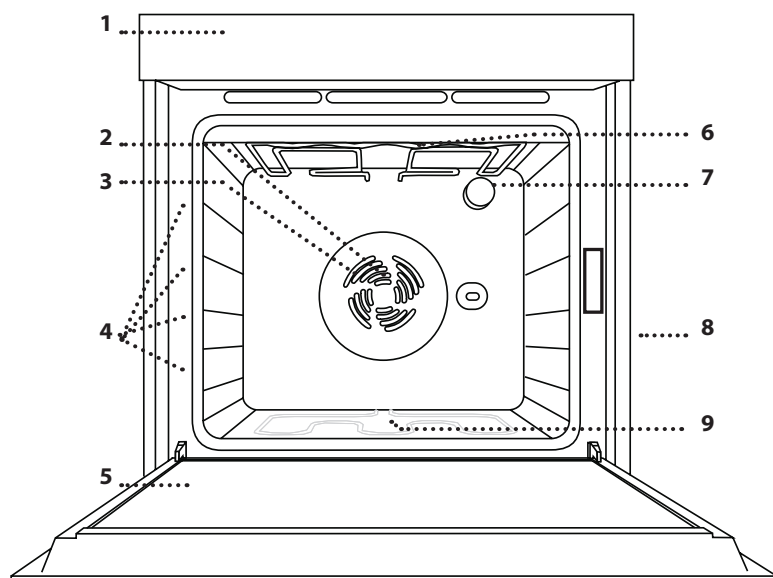

1. Control panel
2. Fan
3. Circular heating element (non-visible)
4. Shelf guides (the level is indicated on the front of the oven)
5. Door
6. Upper heating element/grill
7. Lamp
8. Identification plate (do not remove)
9. Bottom heating element (non-visible)

CONTROL PANEL

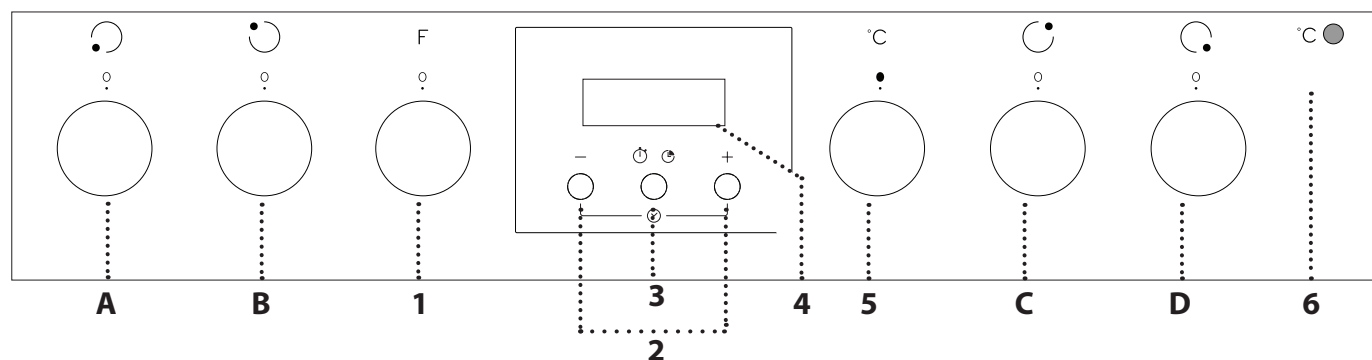

OVEN CONTROLS

1. SELECTION KNOB

For switching the oven on by selecting a function. Turn to the **O** position to switch the oven off.

2. +/- BUTTON

To decrease or increase the value shown on the display.

3. TIME BUTTON

For selecting the various settings: duration, timer.

4. DISPLAY

5. THERMOSTAT KNOB

Turn to select the temperature you require.

6. LED THERMOSTAT/ PREHEATING

Switches on during the heating

process. Switches off once the desired temperature is reached.

CONTROL KNOBS FOR COOKTOP

A. for front left hotplate.
B. for rear left hotplate.
C. for rear right hotplate.
D. for front right hotplate.

Please note: all the knobs are retractable. Press the knobs in the middle and they pop up.

WIRE SHELF

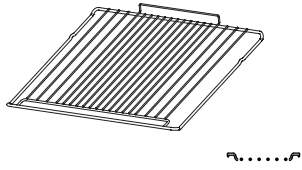

DRIP TRAY (IF PRESENT)

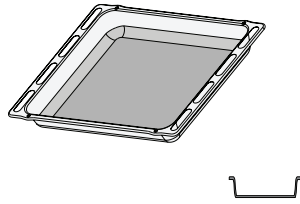

BAKING TRAY

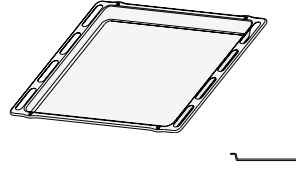

The number and the type of accessories may vary depending on which model is purchased. Other accessories can be purchased separately from the After-sales Service.

INSERTING THE WIRE SHELF AND OTHER ACCESSORIES

- Insert the wire shelf horizontally by sliding it across the shelf guides, making sure that the side with the raised edge is facing upwards.
- Other accessories, such as the drip tray and the baking tray, are inserted horizontally in the same way as the wire shelf.

REMOVING AND REFITTING THE SHELF GUIDES

- To remove the shelf guides, remove the fixing screws (if present) on both sides with the aid of a coin or a tool. Lift the guides up and pull the lower parts out of their seatings: The shelf guides can now be removed.
- To refit the shelf guides, first fit them back into their upper seating. Keeping them held up, slide them into the cooking compartment, then lower them into position in the lower seating. Refit the fixing screws.

FUNCTIONS

OFF
For switching off the oven.

LIGHT
To switch the oven light on/off.

CONVENTIONAL
For cooking any kind of dish on one shelf.

HYDROCLEANING
To eliminate the dirt created by cooking by means of a low temperature cycle. The action of the steam released during this special low-temperature cleaning cycle allows dirt and food residues to be removed with ease. Pour 200 ml of drinking water on the bottom of the oven and use the function for 35' at 90°C. Activate the function when the oven is cold and let it cool down for 15'.

CONVECTION BAKE
For cooking meat and pies with liquid filling (savory or sweet) on a single shelf, and pizzas on one or two shelves. When cooking on two levels, switch the position of the dishes halfway through cooking to cook food more evenly.

GRILL
For grilling steaks, kebabs and sausages, cooking vegetables au gratin or toasting bread. When grilling meat, we recommend using a tray to collect the cooking juices: Position the pan on any of the levels below the wire shelf and add 500 ml of drinking water.

GRATIN
For roasting large joints of meat (legs, roast beef, chicken). We recommend using a tray to collect the cooking juices: Position the pan on any of the levels below the wire shelf and add 500 ml of drinking water. The turnspit (if provided) can be used with this function.

DEFROSTING
To speed up defrosting of food.

TURBOFAN
For food with a crisp base and soft top. Ideal for cooking cakes with liquid filling and no precooked base on a single shelf. This function is also ideal for frozen convenience foods.

MULTILEVEL
For cooking a variety of food requiring the same temperature on two shelves at the same time. This function can be used to cook different foods without odours being transferred from one food to another.

BOTTOM
For browning the bottom of the dishes. The function can also be used for slow cooking, to finish cooking very liquid dishes (sweet or savour) or to thicken sauces and gravies.

USING THE APPLIANCE FOR THE FIRST TIME

1. SETTING THE TIME

You will need to set the time when you switch on the appliance for the first time: "AUTO" and "0.00" flash on the display.



To set the time of day, press buttons $-$ and $+$ at the same time: Set the time of day using the $+$ and $-$ buttons.

Please note: To change the time of the day afterwards for example following lengthy power outages, you will need to reset the time

2. SETTING THE TONE

Having selected the desired time value, press the *time button*: The display shows "ton 1".



To select the desired tone, press button $-$, then press the *time button* to confirm.

3. HEAT THE OVEN

A new oven may release odours that have been left behind during manufacturing; this is completely normal. Before starting to cook food, we therefore recommend heating the oven with it empty in order to remove any possible odours.

Remove any protective cardboard or transparent film from the oven and remove any accessories from inside it. Heat the oven to 250 °C for about one hour, preferably using the "Convection Bake" function. The oven must be empty during this time. Follow the instructions for setting the function correctly.

Please note: It is advisable to air the room after using the appliance for the first time.

DAILY USE

1. SELECT A FUNCTION

To select a function, turn the *selection knob* to the symbol for the function you require.

2. ACTIVATE A FUNCTION

To start the function you have selected, turn the *thermostat knob* to set the temperature you require.

To interrupt the function at any time, switch off the oven, turn the *selection knob* and the *thermostat knob* to 0 and ●.

3. PREHEATING

Once the function has been activated, the LED thermostat will switch on signalling that the preheating process has begun.

At the end of this process, the LED thermostat switches off indicating that the oven has reached the set temperature: at this point, place the food inside and proceed with cooking.

Please note: Placing the food in the oven before preheating has finished may have an adverse effect on the final cooking result.

. PROGRAMMING COOKING

After selecting and activating the function, it is possible to set the duration values.

 DURATION

Press the *time button*: the  symbol flashes.



Press the *time button* again: the display shows DUR and AUTO flashes.

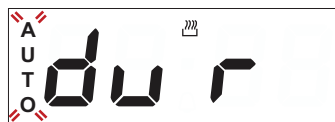

Set the duration using the buttons $+$ and $-$. After a few seconds, the display shows the time of the day while AUTO remains lit, confirming the setting.



To view the remaining cooking time press the *time button* for at least 2 seconds. To change it, if necessary, press it again a second time, using $+$ and $-$ buttons to modify the duration.

At the end of cooking, the symbol  switches off, an alarm sounds and **AUTO** flashes on the display.



Press any button to deactivate the alarm. Return the function knob and *thermostat knob* to 0 and ●, then press the *time button* for at least 2 seconds to switch off the oven.

SETTING THE TIMER

This option does not interrupt or activate cooking but allows you to use the display as a timer, both while a function is active and when the oven is off.

To activate the timer, long press the *time button*: the  symbol flashes on the display.



Use the + and – buttons to set the desired duration: the countdown begins after a few seconds.

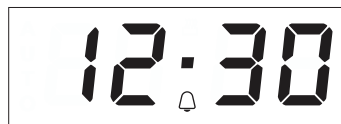

The display shows the time of the day and the  remains lit, confirming the timer has been set.

Please note: To view the countdown and change it if necessary, press the *time button* 2 seconds again.

• **COOKTOP OPERATION**
(see the instructions supplied with the cooktop).

Turn the control knob of the relevant hotplate clockwise to the desired power setting.

The oven control panel features 4 adjustable knobs for cooktop operation. The cooktop control knobs are marked with a numerical scale corresponding to different power settings, and a series of function symbols.

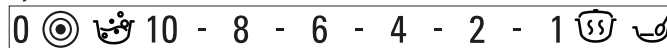

GENTLE HEAT

To allow dough to rise, to soften butter taken from the fridge, to keep baby bottles or food warm, also for making yoghurt, melting chocolate, etc. This function is only available when the residual heat indicator is on. For this function, make sure the residual heat indicator of the desired hotplate is on. Turn the knob to . To deselect the function, change the position of the knob.

HEAT MAINTENANCE

To maintain a constant temperature of 60° until the end of cooking. To select this function, turn the knob to .

FAST BOIL



























































This function is used to bring water to the boil rapidly and remains on for a preset time. At the end of the preset time, the cooktop automatically returns to the maximum power setting. This function can be selected even during cooking. Important: before selecting this function, make sure the pot is positioned on the selected hotplate in order to avoid any damage to the cooktop surface. The stated performance values for this function are those guaranteed for all glass ceramic cooktops. For this function, place the pot on the selected hotplate and turn the knob to . To deselect, change the position of the knob.

MULTIZONE





This is available on the front left and rear left hotplates. This extends the heating area of the cooktop in order to allow the use of large, oval or rectangular pots or cooking receptacles. To select this function: turn the knob to  and wait until the residual heat indicator for the hotplate begins to flash. To switch on the triple zone function (if available), wait until the LED begins flashing quickly. Select the power setting required by turning the knob anticlockwise. The residual heat indicator remains on to indicate that the cooktop is in use. To deselect, turn the knob to 0 by turning the knob anticlockwise.



































Please note: The multizone function can only be switched on for the double and triple hotplates of the cooktop

COOKING TABLE

RECIPE	FUNCTION	PREHEAT	TEMPERATURE (°C)	DURATION (MIN)	LEVEL AND ACCESSORIES
Leavened cakes		Yes	160 - 180	35 - 55	2 
		Yes	150 - 170	30 - 90	3 1  
Filled cakes (cheesecake, strudel, apple pie)		Yes	150 - 190	30 - 85	2 
		Yes	150 - 190	35 - 90	3 1  
Biscuits / Tartlets		Yes	170 - 180	15 - 40	3 
		Yes	150 - 175	20 - 45	3 1  
Choux buns		Yes	180	30 - 40	3 
		Yes	170 - 190	35 - 45	3 1  
Meringues		Yes	90	120 - 130	3 
		Yes	90	130 - 150	3 1  
Bread / Pizza / Focaccia		Yes	190 - 250	15 - 50	2 
		Yes	190 - 250	25 - 50	3 1  
Frozen pizza		Yes	250	10 - 15	2 
		Yes	250	10 - 20	3 1  
Savoury pies (vegetable pie, quiche)		Yes	175 - 200	40 - 50	2 
		Yes	175 - 190	50 - 65	3 1  
Vols-au-vent / Puff pastry crackers		Yes	180 - 200	20 - 30	3 
		Yes	175 - 200	25 - 45	3 1  
Lasagne / Baked pasta / Cannelloni / Flans		Yes	190 - 200	40 - 65	2 
Lamb / Veal / Beef / Pork 1 kg		Yes	190 - 200	90 - 110	2 
Chicken / Rabbit / Duck 1 kg		Yes	190 - 200	65 - 85	2 
Turkey / Goose 3 kg		Yes	190 - 200	140 - 180	1 / 2 
Lamb/veal/beef/pork 1 kg		Yes	180 - 200	40 - 60	2 
Roast pork with crackling 2 kg		Yes	175 - 200	50 - 60	2 
Chicken/rabbit/duck 1 kg		Yes	200	2 - 5	4 

FUNCTIONS					
	Conventional	Grill	Gratin	Forced Air	Convection Bake

ACCESSORIES					
	Wire shelf	Cake tin on wire shelf	Drip tray / baking tray or cake tin on wire shelf	Drip tray / Baking tray	Drip tray with 500 ml of water

RECIPE	FUNCTION	PREHEAT	TEMPERATURE (°C)	DURATION (MIN)	LEVEL AND ACCESSORIES
Turkey/goose 3 kg		Yes	190 - 200	140 - 180	4 3  
Baked fish / en papillote (fillets, whole)		Yes	180 - 200	40 - 60	2 
Stuffed vegetables (tomatoes, courgettes, aubergines)		Yes	175 - 200	50 - 60	2 
Toast		Yes	200	2 - 5	4 
Fish fillets / Steaks		Yes	200	30 - 40 *	4 3  
Sausages / Kebabs / Spare ribs / Hamburgers		Yes	200	30 - 50 *	4 3  
Roast chicken 1-1,3 kg		-	200	55 - 70 *	2 1  
Roast beef rare 1 kg		-	200	35 - 50 **	2 
Leg of lamb / Shanks		-	200	60 - 90 **	2 
Roast potatoes		-	200	45 - 55 **	2 
Vegetable gratin		-	200	20 - 30	2 
Lasagna & Meat		Yes	200	50 - 100 ***	3 1  
Meat & Potatoes		Yes	200	45 - 100 ***	3 1  
Fish & Vegetables		Yes	175	30 - 50 ***	3 1  











* Turn food halfway through cooking.

** Turn food two thirds of the way through cooking (if necessary).

*** Switch levels halfway through cooking.

**** Estimated length of time: dishes can be removed from the oven at different times depending on personal preference.

Download the Use and Care Guide by visiting the website docs.indesit.eu to consult the table of tested recipes filled out for the assessment institutes in accordance with the IEC 60350 - 1 standard.

FUNCTIONS					
	Conventional	Grill	Gratin	Forced Air	Convection Bake
ACCESSORIES					
	Wire shelf	Cake tin on wire shelf	Drip tray / baking tray or cake tin on wire shelf	Drip tray / Baking tray	Drip tray with 500 ml of water

MAINTENANCE AND CLEANING



Download the Use and Care Guide from docs.whirlpool.eu for more information

Make sure that the oven has cooled down before carrying out any maintenance or cleaning.

Do not use steam cleaners.

Do not use wire wool, abrasive scourers or abrasive/corrosive cleaning agents, as these could damage the surfaces of the appliance.

Wear protective gloves.

The oven must be disconnected from the mains before carrying out any kind of maintenance work.

EXTERIOR SURFACES

Clean the surfaces with a damp microfibre cloth. If they are very dirty, add a few drops of pH-neutral detergent. Finish off with a dry cloth. Do not use corrosive or abrasive detergents. If any of these products inadvertently comes into contact with the surfaces of the appliance, clean immediately with a damp microfibre cloth.

INTERIOR SURFACES

• After every use, leave the oven to cool and then clean it, preferably while it is still warm, to remove any

deposits or stains caused by food residues. To dry any condensation that has formed as a result of cooking foods with a high water content, leave the oven to cool completely and then wipe it with a cloth or sponge. Clean the glass in the door with a suitable liquid detergent

- The oven door can be removed to facilitate cleaning.

ACCESSORIES

Soak the accessories in a washing-up liquid solution after use, handling them with oven gloves if they are still hot. Food residues can be removed using a washing-up brush or a sponge.

REPLACING THE LAMP

1. Disconnect the oven from the power supply.
2. Unscrew the cover from the light, replace the bulb and screw the cover back on the light.
3. Reconnect the oven to the power supply.

Please note: Only use 25-40W/230V type E-14, T300°C incandescent lamps, or 20-40W/230 V type G9, T300°C halogen lamps. The bulb used in the product is specifically designed for domestic appliances and is not suitable for general room lighting within the home (EC Regulation 244/2009). Light bulbs are available from our After-sales Service.

- If using halogen bulbs, do not handle them with your bare hands as your fingerprints could cause damage. Do not use the oven until the light cover has been refitted.

REMOVING AND REFITTING THE DOOR

1. To remove the door, open it fully and lower the catches until they are in the unlock position.

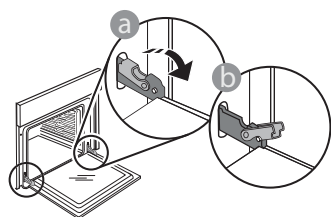

2. Close the door as much as you can. Take a firm hold of the door with both hands – do not hold it by the handle. Simply remove the door by continuing to close it while pulling it upwards at the same time until it is released from its seating. Put the door to one side, resting it on a soft surface.

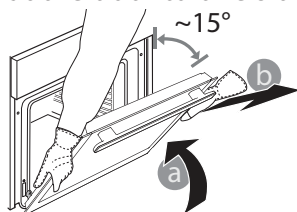

3. Refit the door by moving it towards the oven, aligning the hooks of the hinges with their seating and securing the upper part onto its seating.

4. Lower the door and then open it fully. Lower the catches into their original position: Make sure that you lower them down completely.

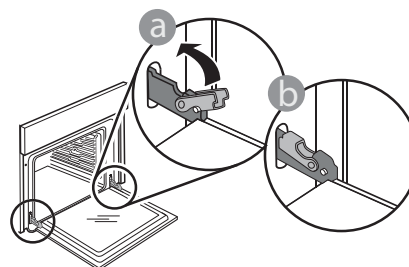

Apply gentle pressure to check that the catches are in the correct position.

5. Try closing the door and check to make sure that it lines up with the control panel. If it does not, repeat the steps above: The door could become damaged if it does not work properly.

Problem	Possible cause	Solution
The oven is not working.	Power cut. Disconnection from the mains.	Check for the presence of mains electrical power and whether the oven is connected to the electricity supply. Turn off the oven and restart it to see if the fault persists.
The display shows the letter "F" followed by a number.	Software problem.	Contact you nearest Client After-sales Service Centre and state the number following the letter "F".

USEFUL TIPS



Download the Use and Care Guide from docs.whirlpool.eu for more information

HOW TO READ THE COOKING TABLE

The table lists the best function, accessories and level to use to cook various different types of food. Cooking times start from the moment food is placed in the oven, excluding preheating (where required). Cooking temperatures and times are approximate and depend on the amount of food and the type of accessory used. Use the lowest recommended settings to begin with and, if the food is not cooked enough, then switch to higher settings. Use the accessories supplied and preferably dark-coloured metal cake tins and baking plates. You can also use Pyrex or stoneware pans and accessories, but bear in mind that cooking times will be slightly longer

COOKING DIFFERENT FOODS AT THE SAME TIME

Using the "Forced Air" function, you can cook different foods which require the same cooking temperature at the same time (for example: fish and vegetables), using different shelves. Remove the food which requires a shorter cooking time and leave the food which requires a longer cooking time in the oven.

PRODUCT FICHE

The product fiche with energy data of this appliance can be downloaded from the website docs.whirlpool.eu

HOW TO OBTAIN THE USE AND CARE GUIDE

> Download the Use and Care Guide from our website docs.whirlpool.eu (you can use this QR Code), specifying the product's commercial code.



> Alternatively, contact our Client After-sales Service.

CONTACTING OUR AFTER-SALES SERVICE

You can find our contact details in the warranty manual. When contacting our Client After-sales Service, please state the codes provided on your product's identification plate.

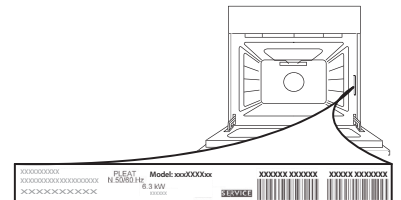

GUIDE D'UTILISATION QUOTIDIENNE



Vous pouvez télécharger les Consignes de sécurité et le Guide d'utilisation et d'entretien en visitant notre site Web docs.whirlpool.eu et en suivant les consignes au dos de ce livret.

! Lire attentivement les Consignes de santé et de sécurité avant d'utiliser l'appareil.

DESCRIPTION DU PRODUIT

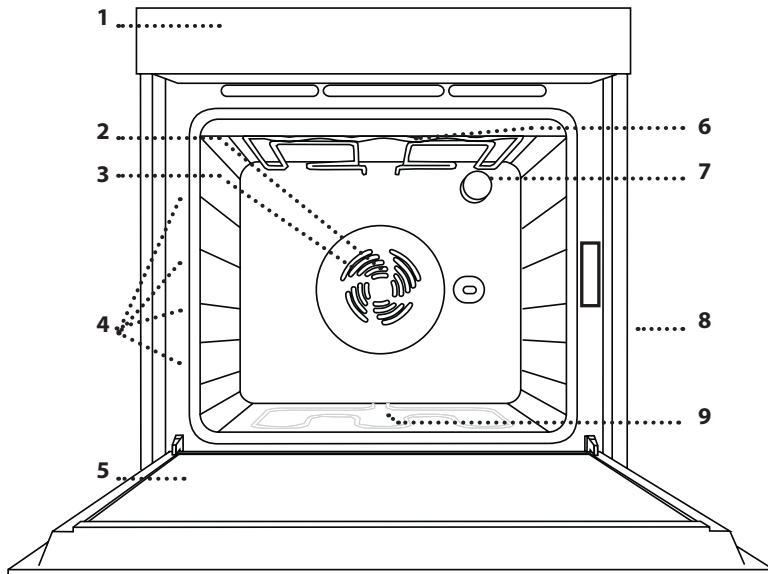

1. Panneau de commande
2. Ventilateur
3. Élément chauffant rond (invisible)
4. Supports de grille (le niveau est indiqué à l'avant du four)
5. Porte
6. Élément chauffant supérieur/grill
7. Ampoule
8. Plaque signalétique (ne pas enlever)
9. Élément chauffant inférieur (invisible)

PANNEAU DE COMMANDE

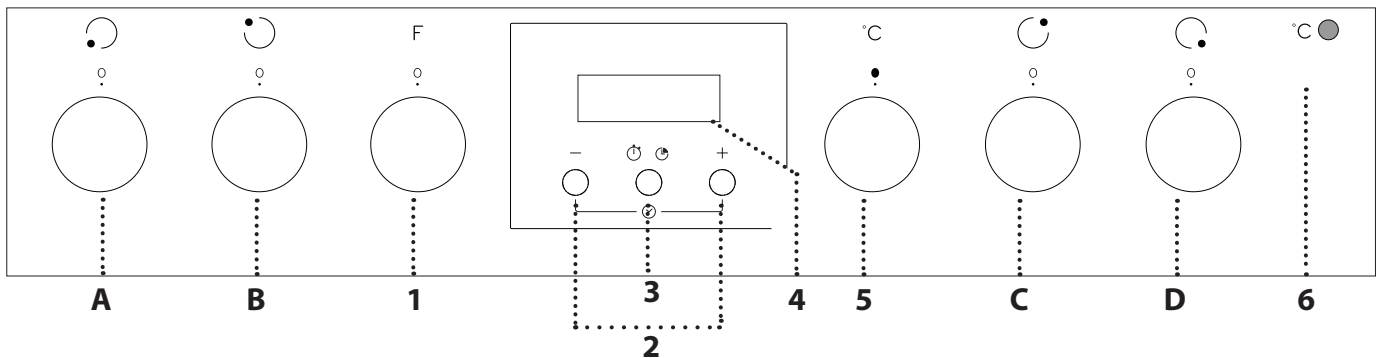

COMMANDES DU FOUR

1. BOUTON DE SÉLECTION

Pour allumer le four en sélectionnant une fonction. Tournez à la position **O** pour éteindre le four.

2. TOUCHE +/-

Pour diminuer ou augmenter la valeur affichée à l'écran

3. TOUCHE HEURE

Pour sélectionner les différents réglages : durée, minuterie.

4. ÉCRAN

5. BOUTON THERMOSTAT

Tournez pour sélectionner la température désirée.

6. VOYANT THERMOSTAT / PRÉCHAUFFAGE

S'allume pendant le processus de chauffage. S'éteint une fois la température désirée atteinte.

BOUTONS DE COMMANDE DE LA TABLE DE CUISSON

- A. pour la zone de cuisson avant gauche.
- B. pour la zone de cuisson arrière gauche.
- C. pour la zone de cuisson arrière droite.
- D. pour la zone de cuisson avant gauche.

Veuillez noter : tous les boutons sont escamotables. Appuyez au centre des boutons pour les faire sortir.

GRILLE MÉTALLIQUE

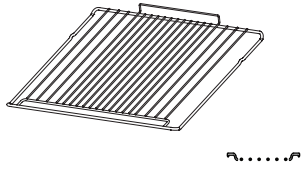

LÈCHEFRITE (SELON LE MODÈLE)

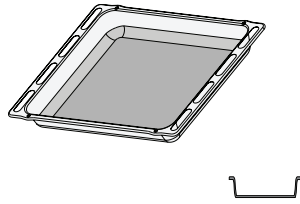

PLAQUE DE CUISSON

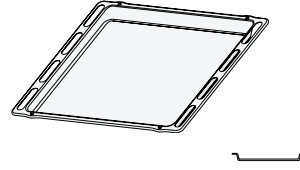

Le nombre et type d'accessoires peuvent varier selon le modèle acheté. Il est possible d'acheter séparément d'autres accessoires auprès du Service Après-Vente.

INSÉRER LA GRILLE MÉTALLIQUE ET LES AUTRES ACCESSOIRES

- Insérez la grille métallique horizontalement en la glissant sur les supports de grille; assurez-vous que le côté avec le bord relevé est placé vers le haut.
- Les autres accessoires, comme la lèche-frite et la plaque de cuisson, sont introduits de la même manière que la grille.

ENLEVER ET REPLACER LES SUPPORTS DE GRILLE

- Pour enlever les supports de grille, enlevez les vis de fixation (selon le modèle) sur les deux côtés à l'aide d'une pièce de monnaie ou d'un outil. Soulevez les supports et sortez les parties inférieures de leurs appuis : Les supports de grille peuvent maintenant être enlevés.
- Pour replacer les supports de grille, vous devez en premier les replacer dans leur appui supérieur. En les maintenant soulevés, glissez-les dans le compartiment de cuisson, abaissez-les ensuite dans leur appui inférieur. Remplacez les vis de fixation.

FONCTIONS

OFF
Pour éteindre le four.

ÉCLAIRAGE
Pour allumer/éteindre la lumière du four.

TRADITIONNEL
Pour cuire tout type de plat sur une seule grille.

HYDROCLEANING
Pour éliminer la saleté créée par la cuisson au moyen d'un cycle basse température. L'action de la vapeur créée lors de ce cycle de nettoyage à basse température spécial permet d'enlever la saleté et les résidus d'aliments plus facilement. Versez 200 ml d'eau potable au fond du four et utilisez la fonction pendant 35' à 90°C. Lancer la fonction lorsque le four est froid et laissez-le refroidir 15 minutes.

CONVECTION FORCÉE
Pour cuire des viandes et des tartes contenant une garniture liquide (salée ou sucrée) sur une seule grille et des pizzas sur une ou deux grilles. Pour une cuisson sur deux niveaux, inversez les plats à mi-cuisson pour obtenir un résultat plus homogène.

GRIL
Pour cuire des biftecks, des brochettes, et des saucisses, faire gratiner des légumes et griller du pain. Pour la cuisson de la viande, nous vous conseillons d'utiliser une lèche-frite pour recueillir les jus de cuisson : Placez la lèche-frite, contenant 500 ml d'eau, sur n'importe quel niveau sous la grille.

GRATIN
Pour griller de gros morceaux de viande (gigots, rôti de bœuf, poulet). Nous vous conseillons d'utiliser une lèche-frite pour recueillir les jus de cuisson : Placez la lèche-frite, contenant 500 ml d'eau, sur n'importe quel niveau sous la grille. Le tournebroche (selon le modèle) peut être utilisé avec cette fonction.

DÉCONGÉLATION
Pour accélérer la décongélation des aliments.

VENTILATEUR TURBO
Pour les aliments avec une base croustillante et un dessus moelleux. Idéale pour cuire sur un seul niveau des tartes avec une garniture liquide sans base pré-cuite. Cette fonction est aussi idéale pour les produits surgelés.

MULTI-NIVEAU
Pour cuire des aliments différents, nécessitant la même température de cuisson, en même temps sur deux grilles. Cette fonction permet de cuire différents aliments sans transmettre les odeurs d'un aliment à l'autre.

FOND
Pour dorer le fond des plats. La fonction peut aussi être utilisée pour la cuisson lente, pour compléter la cuisson de plat très liquide (sucrés ou salés), ou pour épaissir les sauces.

UTILISER L'APPAREIL POUR LA PREMIÈRE FOIS

1. RÉGLAGE DE L'HEURE

Vous devez régler l'heure lorsque vous allumez l'appareil pour la première fois : « AUTO » et « 0.00 » clignotent à l'écran.



Pour régler l'heure, appuyez sur les touches — et ++ en même temps : Réglez l'heure à l'aide des touches + et —.

Veillez noter: Pour changer l'heure (par exemple, après une panne de courant prolongée, vous devrez régler l'heure de nouveau)

2. RÉGLER LA TONALITÉ

Après avoir sélectionné l'heure désiré, appuyez sur la *touche heure* : L'affichage indique « ton 1 ».



Pour sélectionner la tonalité désirée, appuyez sur la touche —, appuyez ensuite sur la *touche heure* pour confirmer.

3. CHAUFFER LE FOUR

Un nouveau four peut dégager des odeurs provenant de la fabrication : ceci est parfaitement normal. Avant de cuire des aliments, nous vous conseillons de chauffer le four à vide pour éliminer les odeurs. Enlevez les cartons de protection ou les pellicules transparentes du four, et enlevez les accessoires qui se trouvent à l'intérieur. Chauffez le four à 250 °C pour environ une heure en utilisant la fonction « Convection forcée ». Le four doit être vide durant cette opération. Suivez les directives pour régler correctement la fonction.

Veillez noter: Nous vous conseillons d'aérer la pièce après avoir utilisé l'appareil pour la première fois.

UTILISATION QUOTIDIENNE

1. SÉLECTIONNER UNE FONCTION

Pour sélectionner une fonction, tournez le *bouton de sélection* sur le voyant de la fonction désirée.

2. ACTIVER UNE FONCTION

Pour lancer la fonction que vous avez sélectionnée, tournez le *bouton du thermostat* pour régler la température requise.

Pour interrompre la fonction en tout temps ou éteindre le four, tournez le *bouton de sélection* et le *bouton de thermostat* à 0 et ●.

3. PRÉCHAUFFAGE

Une fois la fonction lancée, le voyant du thermostat s'allume pour vous indiquer que le préchauffage est en cours.

À la fin du processus, le voyant du thermostat s'éteint pour vous indiquer que le four a atteint la température désirée : vous pouvez maintenant placer les aliments à l'intérieur et débiter la cuisson.

Veillez noter: Placer les aliments dans le four avant la fin du préchauffage peut affecter la qualité de la cuisson.

PROGRAMMER LA CUISSON

Après avoir sélectionné et activé la fonction, il est possible de régler la durée.



DURÉE

Appuyez sur la *touche heure* : le voyant 🔔 clignote.



Appuyez sur la *touche heure* de nouveau : l'écran affiche « DUR » et « AUTO » clignote.

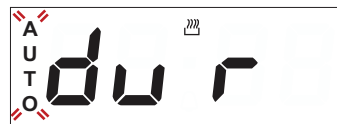

Réglez la durée à l'aide des touches + et —. Après quelques secondes, l'écran affiche l'heure alors qu' AUTO reste allumé, confirmant le réglage.



Pour voir le temps de cuisson restant, appuyez sur la *touche heure* pendant au moins 2 secondes. Pour le changer, au besoin, appuyez de nouveau en utilisant les touches + et — pour modifier la durée. À la fin de la cuisson, le voyant 🔔 s'éteint, une alarme sonore retentit, et **AUTO** clignote à l'écran.



Appuyez sur une touche quelconque pour désactiver l'alarme.

Retournez le bouton de fonction et le bouton *Thermostat* à 0 et ●, appuyez ensuite sur la *touche heure* pour au moins 2 secondes pour éteindre le four.

RÉGLER LA MINUTERIE

Cette option n'interrompt pas ou ne lance pas la cuisson, mais vous permet d'utiliser l'écran comme minuterie, durant le fonctionnement d'une fonction ou quand le four est éteint.

Pour activer la minuterie, appuyez fermement sur la *touche heure* : le voyant clignote à l'écran.



Utilisez les touches + et – pour régler la durée désirée : le compte à rebours démarre après quelques secondes.



L'écran affiche l'heure et le reste allumé, confirmant que la minuterie a été réglée.

Veillez noter: Pour afficher le compte à rebours et le changer, au besoin, appuyez de nouveau sur la *touche heure* pendant au moins 2 secondes.

• **FONCTIONNEMENT DE LA TABLE DE CUISSON**
(suivez les instructions qui accompagnent la table de cuisson).

Tournez le bouton de commande de la plaque chauffante sélectionnée dans le sens horaire jusqu'à la position désirée.

Le panneau de commandes du four présente 4 boutons réglables pour le fonctionnement de la table de cuisson. Les boutons de commande de la table de cuisson portent une échelle numérique correspondant à différentes puissances, ainsi qu'une série de symboles de fonction.

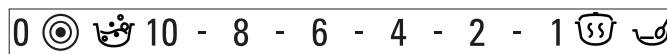

CHAUFFAGE LENT

Utilisez cette fonction pour faire lever une pâte, ramollir une plaquette de beurre dur sortie du réfrigérateur, réchauffer un biberon ou le repas d'un bébé, fabriquer du yaourt, faire fondre du chocolat, etc. Cette fonction est disponible uniquement lorsque l'indicateur de chaleur résiduelle est allumé. Vérifiez que l'indicateur de chaleur résiduelle de la zone de cuisson que vous désirez utiliser est allumé. Positionnez le bouton sur . Pour désactiver la fonction, changez la position du bouton.

MAINTIEN AU CHAUD

Cette fonction permet de maintenir la température du four à 60 °C jusqu'à la fin du cycle de cuisson. Pour sélectionner cette fonction, réglez le bouton sur .

ÉBULLITION RAPIDE



























































Cette fonction permet d'amener rapidement l'eau à ébullition et reste active pendant la durée prédéfinie. Dès que la durée de cuisson est écoulée, la table de cuisson retourne automatiquement à la puissance maximale. La fonction Ébullition rapide peut également être activée une fois que vous avez déjà commencé à cuisiner. Important : Veillez à placer l'ustensile de cuisson sur la zone de cuisson avant d'activer la fonction Ébullition rapide. À défaut, vous risqueriez d'endommager la surface vitrocéramique. Les performances spécifiées pour la fonction Ébullition rapide sont garanties pour tous les types de tables de cuisson vitrocéramiques. Pour activer la fonction, placez la cocotte sur la zone de cuisson désirée et réglez le bouton sur . Pour désactiver la fonction, changez la position du bouton.

MULTI ZONE



Disponible sur les plaques chauffantes avant gauches et arrière gauches. Ceci permet d'étendre la zone chauffante de la table de cuisson de façon à permettre l'utilisation de casseroles ou de plats de cuisson de grande taille, de forme ovale ou rectangulaire. Pour sélectionner cette fonction : tournez le bouton sur et attendez que le voyant de chaleur résiduelle de la plaque chauffante commence à clignoter. Pour activer la triple zone (si présente), attendez que le clignotement du voyant s'accélère. Sélectionnez la puissance désirée en tournant le bouton dans le sens inverse des aiguilles d'une montre. L'indicateur de chaleur résiduelle reste allumé, indiquant que la table de cuisson est allumée. Pour supprimer cette fonction, positionnez le bouton sur 0.

Veillez noter: La fonction Multizone peut uniquement être utilisée pour les plaques chauffantes double et triple de la table de cuisson

TABLEAU DE CUISSON

RECETTE	FONCTION	PRÉCHAUFFER	TEMPÉRATURE (°C)	DURÉE (MIN)	NIVEAU ET ACCESSOIRES
Gâteaux à pâte levée		Oui	160 - 180	35 - 55	2 
		Oui	150 - 170	30 - 90	3 1  
Gâteaux fourrés (gâteau au fromage, strudel, tarte aux pommes)		Oui	150 - 190	30 - 85	2 
		Oui	150 - 190	35 - 90	3 1  
Biscuits/Tartelettes		Oui	170 - 180	15 - 40	3 
		Oui	150 - 175	20 - 45	3 1  
Chouquettes		Oui	180	30 - 40	3 
		Oui	170 - 190	35 - 45	3 1  
Meringues		Oui	90	120 - 130	3 
		Oui	90	130 - 150	3 1  
Pain/Pizza/Fougasse		Oui	190 - 250	15 - 50	2 
		Oui	190 - 250	25 - 50	3 1  
Pizza congelée		Oui	250	10 - 15	2 
		Oui	250	10 - 20	3 1  
Tourtes (tourte aux légumes, quiche)		Oui	175 - 200	40 - 50	2 
		Oui	175 - 190	50 - 65	3 1  
Vol-au-vent/Feuilletés		Oui	180 - 200	20 - 30	3 
		Oui	175 - 200	25 - 45	3 1  
Lasagnes / pâtes cuites / cannellonis / tartes		Oui	190 - 200	40 - 65	2 
Agneau / veau / bœuf / porc 1 kg		Oui	190 - 200	90 - 110	2 
Poulet / lapin / canard 1 kg		Oui	190 - 200	65 - 85	2 
Dinde / Oie 3 kg		Oui	190 - 200	140 - 180	1 / 2 
Agneau / veau / bœuf / porc 1 kg		Oui	180 - 200	40 - 60	2 
Porc rôti avec grattons 2 kg		Oui	175 - 200	50 - 60	2 
Poulet/lapin/canard 1 kg		Oui	200	2 - 5	4 

FONCTIONS					
	Convection naturelle	Gril	Gratin	Chaleur pulsée	Convection forcée

ACCESSOIRES					
	Grille métallique	Moule à gâteaux sur la grille	Lèche-frite/plaque à pâtisserie ou moule à gâteaux sur grille	Lèche-frite / Plaque de cuisson	Lèche-frite contenant 500 ml d'eau

RECETTE	FONCTION	PRÉCHAUFFER	TEMPÉRATURE (°C)	DURÉE (MIN)	NIVEAU ET ACCESSOIRES
Dinde/oie 3 kg		Oui	190 - 200	140 - 180	4 3
Poisson au four / en papillote (filet, entier)		Oui	180 - 200	40 - 60	2
Légumes farcis (tomates, courgettes, aubergines)		Oui	175 - 200	50 - 60	2
Rôtie		Oui	200	2 - 5	4
Filets de poisson / biftecks		Oui	200	30 - 40 *	4 3
Saucisses / brochettes / côtes levées / hamburgers		Oui	200	30 - 50 *	4 3
Poulet rôti 1 - 1,3 kg		-	200	55 - 70 *	2 1
Rosbif saignant 1 kg		-	200	35 - 50 **	2
Cuisse d'agneau / Jarrets		-	200	60 - 90 **	2
Pommes de terre rôties		-	200	45 - 55 **	2
Légumes gratinés		-	200	20 - 30	2
Lasagnes & Viandes		Oui	200	50 - 100 ***	3 1
Viandes & Pommes de terre		Oui	200	45 - 100 ***	3 1
Poisson & légumes		Oui	175	30 - 50 ***	3 1

* Tourner les aliments à mi-cuisson.

** Au besoin, retournez les aliments aux deux tiers de la cuisson).

*** Changez les niveaux à la mi-cuisson.

**** Temps approximatif : les plats peuvent être retirés du four en tout temps, selon vos préférences personnelles.

Téléchargez le Guide d'utilisation et d'entretien en visitant notre site Web docs.indesit.eu pour consulter le tableau de recettes testées pour les institutions d'évaluation conformément à la norme CEI 60350- 1.

FONCTIONS					
	Convection naturelle	Gril	Gratin	Chaleur pulsée	Convection forcée
ACCESSOIRES					
	Grille métallique	Moule à gâteaux sur la grille	Lèche-frite/plaque à pâtisserie ou moule à gâteaux sur grille	Lèche-frite / Plaque de cuisson	Lèche-frite contenant 500 ml d'eau

NETTOYAGE ET ENTRETIEN



Pour plus d'information, téléchargez le Guide d'utilisation et d'entretien sur docs.whirlpool.eu

Assurez-vous que l'appareil est froid avant de le nettoyer ou d'effectuer des travaux d'entretien.

N'utilisez pas de nettoyeur à vapeur.

N'utilisez pas de laine d'acier, de tampons à récurer abrasifs, ou des détergents abrasifs ou corrosifs, ils pourraient endommager les surfaces de l'appareil.

Utilisez des gants de protection.

L'appareil doit être débranché de l'alimentation principale avant d'effectuer des travaux d'entretien.

SURFACES EXTÉRIEURES

Nettoyez les surfaces à l'aide d'un chiffon en microfibre humide.

Si elles sont très sales, ajoutez quelques gouttes de détergent à pH neutre. Essuyez avec un chiffon sec. N'utilisez pas de détergents corrosifs ou abrasifs. Si l'un de ces produits entre en contact avec des surfaces de l'appareil, nettoyez immédiatement à l'aide d'un chiffon en microfibre humide.

SURFACES INTÉRIEURES

• Après chaque utilisation, laissez le four refroidir et nettoyez-le, de préférence lorsqu'il est encore tiède, pour enlever les dépôts ou taches laissés par les

résidus de nourriture.

Pour enlever la condensation qui se serait formée lors de la cuisson d'aliments avec une forte teneur en eau, laissez le four refroidir complètement et essuyez-le avec un chiffon ou une éponge. Nettoyer la vitre de la porte avec un détergent adéquat

• La porte du four peut être enlevée pour faciliter le nettoyage .

ACCESSOIRES

Faire tremper les accessoires dans de l'eau contenant un détergent à vaisselle; utilisez des gants de cuisine s'ils sont encore chauds. Utilisez une brosse à vaisselle ou une éponge pour enlever les résidus d'aliments.

REPLACEMENT DE L'AMPOULE

1. Débranchez le four.
2. Dévissez le couvercle de l'ampoule, remplacez l'ampoule, et revissez le couvercle.
3. Rebranchez le four à l'alimentation électrique.

Veillez noter: Utilisez uniquement des ampoules à incandescence de 25-40 W/230 V type E-14, T300 °C, ou des ampoules halogènes de 20-40W/230 V type G9, T300 °C. L'ampoule utilisée dans l'appareil est spécialement conçue pour les appareils électroménagers et ne convient pas pour l'éclairage d'une pièce de la maison (Règlement CE 244/2009). Ces ampoules sont disponibles auprès de notre Service après-vente.

- Ne manipulez pas les ampoules à halogène à mains nues, les traces laissées par vos empreintes pourraient les endommager. Avant d'utiliser le four, assurez-vous que le couvercle de l'ampoule a bien été remis en place.

ENLEVER ET RÉINSTALLER LA PORTE

1. Pour enlever la porte, ouvrez-la complètement et abaissez les loquets jusqu'à qu'ils soient déverrouillés.

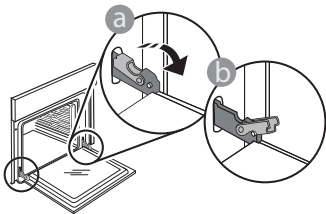

2. Fermez le plus possible la porte. Tenez la porte fermement avec les deux mains – ne la tenez pas par la poignée. Enlevez simplement la porte en continuant à la fermer tout en la tirant vers le haut jusqu'à ce qu'elle soit dégagée de ses appuis. Placez la porte de côté, l'appuyant sur une surface souple. Placez la porte de côté, l'appuyant sur une surface souple.

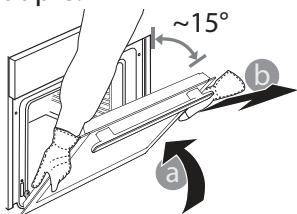

3. Réinstallez la porte en la plaçant devant le four pour aligner les crochets des charnières avec leurs appuis, et insérez la partie supérieure sur son appui.

4. Abaissez la porte pour ensuite l'ouvrir complètement. Abaissez les loquets dans leur position originale : Assurez-vous de les abaisser complètement.

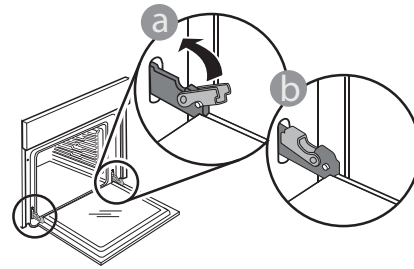

Appliquez une légère pression pour vous assurer que les loquets sont bien placés.

5. Essayez de fermer la porte et assurez-vous qu'elle est alignée avec le panneau de commande. Sinon, répétez les étapes précédentes : La porte pourrait s'endommager si elle ne fonctionne pas correctement.

Problème	Cause possible	Solution
Le four ne fonctionne pas.	Coupure de courant. Débranchez de l'alimentation principale.	Assurez-vous qu'il n'y a pas de panne de courant et que le four est bien branché. Éteignez puis rallumez le four pour voir si le problème persiste.
L'écran affiche la lettre « F » suivi d'un numéro.	Problème de logiciel.	Prenez en note le numéro qui suit la lettre « F » et contactez le Service Après-vente le plus près.

CONSEILS UTILES



Pour plus d'information, téléchargez le Guide d'utilisation et d'entretien sur docs.whirlpool.eu

COMMENT LIRE LE TABLEAU DE CUISSON

Le tableau indique la meilleure fonction, les accessoires, et le niveau à utiliser pour la cuisson des différents types d'aliments. Les temps de cuisson commencent au moment de l'introduction du plat dans le four et ne tiennent pas compte du préchauffage (s'il est nécessaire). Les températures et temps de cuisson sont approximatifs et dépendent de la quantité d'aliments et du type d'accessoire. Pour commencer, utilisez les valeurs conseillées les plus basses, et si les aliments ne sont pas assez cuits, augmentez-les. Utilisez les accessoires fournis, et de préférence des moules à gâteau en métal foncés et des plats de cuisson. Vous pouvez aussi utiliser des plaques et accessoires en pyrex ou en céramique ; cependant, les temps de cuisson seront sensiblement plus longs

CUIRE DES ALIMENTS DIFFÉRENTS EN MÊME TEMPS

La fonction « Chaleur pulsée » permet de cuire simultanément plusieurs aliments nécessitant la même température de cuisson (par exemple : poisson et légumes), sur différentes grilles. Enlevez les aliments qui demandent moins de cuisson et laissez dans le four les aliments qui ont besoin de plus de cuisson.

FICHE TECHNIQUE

La fiche technique de l'appareil, incluant les taux d'efficacité énergétique, peuvent être téléchargées sur notre site Web docs.whirlpool.eu

COMMENT OBTENIR LE GUIDE D'UTILISATION ET ENTRETIEN

> Téléchargez le Guide d'utilisation et d'entretien sur notre site Web docs.whirlpool.eu (vous pouvez utiliser ce code QR), en précisant le code commercial du produit.



> Une autre façon est de contacter notre Service Après-vente.

CONTACTER LE SERVICE APRÈS-VENTE

Vous pouvez trouver les informations pour nous contacter dans le livret de garantie. Lorsque vous contactez notre Service Après-vente, veuillez indiquer les codes disponibles sur la plaque signalétique de l'appareil.

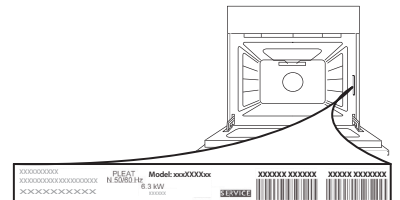

400011603916/B



SNELLE REFERENTIEGIDS



U kunt de Veiligheidsinstructies en de Gids voor Gebruik en Onderhoud downloaden van onze website docs.whirlpool.eu en de instructies aan de achterzijde van dit boekje opvolgen.



Lees voordat u het apparaat gaat gebruiken zorgvuldig de gids voor Gezondheid en Veiligheid.

PRODUCTBESCHRIJVING

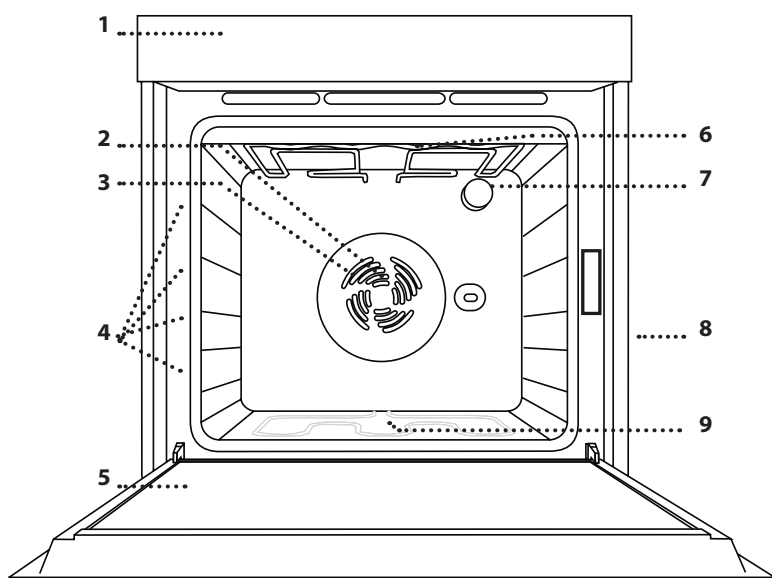

1. Bedieningspaneel
2. Ventilator
3. Circulair verwarmingselement (niet zichtbaar)
4. Roostergeleiders (het niveau staat aangegeven op de voorkant van de oven)
5. Deur
6. Bovenste verwarmingselement/grill
7. Lamp
8. Identificatieplaatje (niet verwijderen)
9. Onderste verwarmingselement (niet zichtbaar)

BEDIENINGSPANEEL

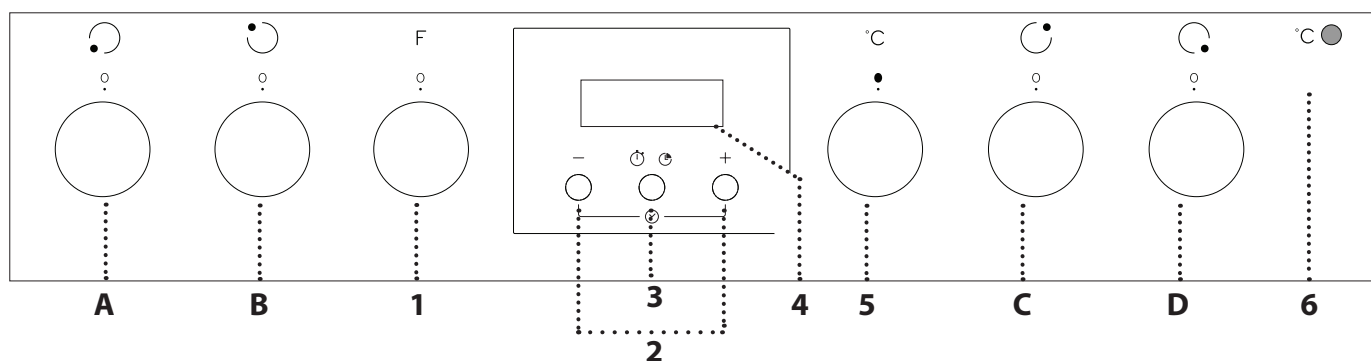

BEDIENINGSELEMENTEN OVEN

1. SELECTIEKNOP

Om de oven in te schakelen door het selecteren van een functie. De schakelaar op O draaien om de oven uit te schakelen.

2. +/- TOETS

Voor het verhogen of verlagen van de waarde op de display.

3. TIJDTOETS

Voor het selecteren van diverse instellingen: duur, kookwekker.

4. DISPLAY

5. THERMOTAATKNOP

Draai om de gewenste temperatuur te selecteren.

6. LED THERMOTAAT/VOORVERWARMING

Gaat aan tijdens het verwarmen.

Gaat uit eens de gewenste temperatuur bereikt is.

BEDIENINGSKNOPPEN KOOKPLAAT

- A. voor kookzone linksvoor.
- B. voor kookzone linksachter.
- C. voor kookzone rechtsachter.
- D. voor kookzone rechtsvoor.

Let op: alle knoppen zijn verzonken. Druk op het midden van de knop om ze uit hun zitting te laten komen.

ROOSTER

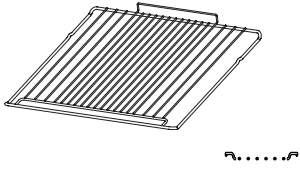

DRUIPPLAAT (INDIEN AANWEZIG)

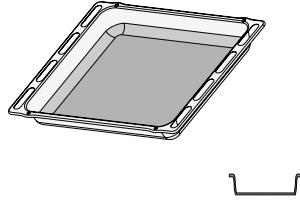

BAKPLAAT

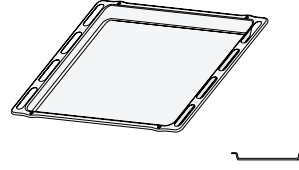

Het aantal en type van accessoires is afhankelijk van het model dat u aangekocht hebt. Bij de Whirlpool Consumentenservice kunt u apart andere accessoires aanschaffen.

PLAATSEN VAN HET ROOSTER EN ANDERE ACCESSOIRES

- Schuif het rooster horizontaal over de geleiders en zorg ervoor dat de zijde met de geheven rand naar boven gericht is.
- Andere accessoires, zoals de opvangbak en de bakplaat, worden op dezelfde wijze als het rooster horizontaal in de oven geschoven.

DE GELEIDERS VAN HET ROOSTER VERWIJDEREN EN TERUGPLAATSEN

- Om de roostergeleiders te verwijderen, verwijdert u de schroeven (indien aanwezig) aan beide kanten met behulp van een munt of een gereedschap. Til de geleiders op en trek de onderste gedeelten uit hun zittingen: De roostergeleiders kunnen nu verwijderd worden.
- Om de geleiders opnieuw te plaatsen, moeten ze eerst terug in hun bovenste zitting worden geplaatst. Houd ze rechtop, schuif ze in de ovenruimte en laat ze dan in de juiste positie in de onderste zitting zakken. Monteer de bevestigingsschroeven weer.

FUNCTIES



OFF

Om de oven uit te schakelen.



LAMPJES

Om het ovenlampje in/uit te schakelen.



CONVENTIONEEL

Voor het bereiden van gerechten op één steunhoogte.



HYDROCLEANING

Voor het verwijderen van door bereiding ontstaan vuil door middel van een lagetemperatuurcyclus. Door de werking van de waterdamp die tijdens deze speciale reinigingscyclus op lage temperatuur vrijkomt kunnen vuil en voedselresten gemakkelijk worden verwijderd. Doe 200 ml drinkbaar water onder in de oven en gebruik de functie gedurende 35' op 90°C. Activeer de functie wanneer de oven koud is en laat 15' afkoelen.



CONVECTIEBAKKEN

Voor het bereiden van vlees en taarten met een vloeibare vulling (hartig of zoet) op één steunhoogte en pizza's op één of twee steunhoogtes. Bij bereiding op twee steunhoogtes wordt geadviseerd om de gerechten halverwege de bereiding van plaats te verwisselen voor een gelijkmatiger resultaat.



GRILL

Voor het grillen van karbonades, spiesen en worstjes, gratineren van groenten of om brood te roosteren. Voor het grillen van vlees wordt geadviseerd de opvangbak te gebruiken om het braadvet op te vangen: Plaats de pan op één van de niveaus onder het rooster en voeg 500 ml drinkwater toe.



GRATIN

Voor het grillen van grote stukken vlees (lamsbouten, rosbief, hele kip). Er wordt geadviseerd de bakplaat te gebruiken om het braadvet op te vangen: Plaats de pan op één van de niveaus onder het rooster en voeg 500 ml drinkwater toe. Het braadspit (indien aanwezig) kan met deze functie worden gebruikt.



BEZIG MET ONTDOOIEN

Voor het versnellen van het ontdooien van voedsel.



TURBOVENTILATOR

Voor voedsel met een krokante bodem en een zachte korst. Ideaal voor het bereiden van taarten met een vloeibare vulling zonder voorgebakken bodem op één steunhoogte. Deze functie is ook ideaal voor diepvriesproducten.



MEER NIVEAUS

Voor het gelijktijdig bereiden van verschillende gerechten op twee steunhoogtes die dezelfde bereidingstemperatuur hebben. Met deze functie worden er geen geuren van het ene naar het andere gerecht overgebracht.



ONDERWARMTE

Om de onderzijde van de gerechten mooi bruin te bakken. De functie kan ook gebruikt worden voor slow cooking, om de bereiding van heel vloeibare gerechten af te ronden (zoet of hartig) of om sauzen en jus in te dikken.

HET APPARAAT VOOR HET EERST GEBRUIKEN

1. INSTELLING VAN HET HUIDIGE TIJDSTIP

Stel de tijd in wanneer u de oven voor de eerste keer aan zet: "AUTO" en "0.00" knipperen op de display.



Om de tijd in te stellen, drukt u tegelijkertijd op — en +: Stel de tijd in met behulp van knop + en —.

Let op: Om de tijd op een later moment te wijzigen, vb. na een langdurige stroomuitval, moet de tijd gereset worden

2. DE TOON INSTELLEN

Na selectie van de gewenste tijdwaarde, druk op de *tijdtoets*: Op de display wordt "ton 1" weergegeven.



Om de gewenste toon te selecteren, druk op — en vervolgens op de *tijdtoets* om te bevestigen.

3. DE OVEN VERWARMEN

Een nieuwe oven kan geuren afgeven die tijdens het productieproces zijn achtergebleven: dit is volkomen normaal. Voordat u begint met het bereiden van voedsel, raden we daarom aan om de lege oven te verwarmen, om alle mogelijke geuren te verwijderen. Verwijder alle beschermende karton of transparante film uit de oven en verwijder eventuele accessoires aan de binnenkant. Verwarm de oven tot 250 °C gedurende ongeveer een uur met de functie "Convectiebakken". De oven moet leeg zijn gedurende deze tijd. Volg de instructies voor de correcte instelling van de functie.

Let op: Het is raadzaam de ruimte te luchten na het eerste gebruik van het apparaat.

DAGELIJKS GEBRUIK

1. SELECTEREN VAN EEN FUNCTIE

Om een functie te selecteren, draai de *keuzeknop* op het symbool van de gewenste functie.

2. EEN FUNCTIE INSCHAKELEN

Om de geselecteerde functie te starten, draai de *thermostaatknop* op de gewenste temperatuur.

Om de functie te onderbreken, zet de oven uit, draai de *keuzeknop* en de *thermostaatknop* op 0 en ●.

3. VOORVERWARMEN

Eens de functie geactiveerd is, brandt de LED van de thermostaat om aan te geven dat het voorverwarmen begonnen is.

Na afloop van dit proces gaat de LED van de thermostaat uit om aan te geven dat de oven de ingestelde temperatuur bereikt heeft: plaats het voedsel in de oven en ga verder met het bereiden.

Let op: Het voedsel in de oven plaatsen vooraleer de fase van de voorverwarming afgelopen is zal een negatief effect hebben op het uiteindelijke resultaat van de bereiding.

. PROGRAMMEREN VAN DE BEREIDING

Na selectie en activering van de functie, kan de duur ingesteld worden.



DUUR

Druk op de *tijdtoets*: het  symbool knippert.



Druk nogmaals op de *tijdtoets*: op de display wordt DUR en AUTO ernaast knipperend weergegeven.

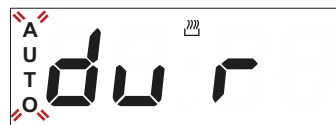

Stel de duur in door op de toetsen + en — te drukken. Na enkele seconden geeft de display de tijd weer en blijft AUTO branden om de instelling te bevestigen.



Om de resterende bereidingstijd te zien, druk minstens 2 seconden lang op de *tijdtoets*. Om te wijzigen, druk nogmaals en gebruik de knoppen + en — om de duur aan te passen.

Aan het einde van de bereiding wordt het symbool  uitgeschakeld, weerklinkt het alarm en knippert **AUTO** op de display.



Druk op een willekeurige knop om het alarm te deactiveren.

Draai de functieknop en de *thermostaatknop* weer op 0 en ●, en druk gedurende minstens 2 seconden op de *tijdtoets* om de oven uit te zetten.

INSTELLEN VAN DE KOOKWEKKER

Deze optie stopt of start de bereiding niet maar geeft u de mogelijkheid om de display te gebruiken als kookwekker (timer), zowel wanneer een functie actief is als wanneer de oven uit staat.

Om de kookwekker te activeren, druk langdurig op de *tijdtoets*: het symbool knippert op de display.



Gebruik de knoppen + en – om de duur in te stellen: Het aftellen begint na enkele seconden.



Op de display wordt de tijd weergegeven en blijft branden om te bevestigen dat de kookwekker is ingesteld.

Let op: Om het aftellen weer te geven en indien nodig te wijzigen, drukt u nogmaals gedurende 2 seconden op de *tijdtoets*.

• WERKING VAN DE KOOKPLAAT

(raadpleeg de gebruiksaanwijzing die bij de kookplaat wordt geleverd).

Draai de bedieningsknop van de betreffende kookzone naar rechts op de gewenste stand.

Op het bedieningspaneel bevinden zich 4 knoppen voor de bediening van de kookplaat. Op de knoppen worden de verschillende stroomstanden met nummers aangegeven en de verschillende functies met symbolen.

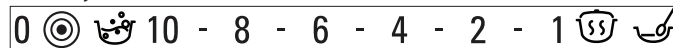

GEMATIGD VERWARMEN

Deze functie is geschikt voor het laten rijzen van deeg, om koude boter zacht te laten worden, babyzuigflessen of pap warm te houden, om yoghurt te maken, chocolade te smelten, etc. Is alleen beschikbaar als het restwarmtelampje brandt. Controleer eerst of het restwarmtelampje van de betreffende kookzone brandt. Draai vervolgens de knop op . De functie wordt uitgeschakeld door de stand van de knop te wijzigen.

WARMHOUDEN

Zorgt voor een constante temperatuur van 60 °C tot het einde van de bereidingstijd. Draai de knop naar om deze functie te selecteren.

SNELKOKEN



























































Deze functie zorgt ervoor dat water snel aan de kook wordt gebracht; de functie blijft een vaste tijd ingeschakeld. Als de tijd om is, schakelt de kookzone automatisch terug naar de maximale stroomstand. De snelkookfunctie kan ook geactiveerd worden nadat u al op de betreffende kookzone met koken bent begonnen. Belangrijk: Zorg er alvorens deze functie te selecteren voor dat de pan op de geselecteerde kookzone is geplaatst om beschadiging van de kookplaat te voorkomen. De gespecificeerde prestatiewaarden voor deze functie worden gegarandeerd voor alle glaskeramische kookplaten. Om deze functie in te schakelen zet u de pan eerst op de geselecteerde kookzone en draait u de knop vervolgens op . De functie wordt uitgeschakeld door de stand van de knop te wijzigen.

MULTIZONE





Is beschikbaar voor de kookzones linksvoor en linksachter. Breidt het verwarmde gebied van de kookplaat uit, zodat u grote, ovale of rechthoekige pannen kunt gebruiken. Om deze functie in te schakelen: draai de knop en wacht tot het restwarmtelampje van de betreffende kookzone gaat knipperen. Wacht totdat het lampje sneller begint te knipperen om de driedubbele zone (indien aanwezig) in te schakelen. Kies de gewenste stand door de knop naar links te draaien. Het restwarmtelampje blijft branden om aan te geven dat de kookplaat is ingeschakeld. Draai de knop naar 0 om de functie uit te schakelen.



































Let op: De multizone-functie werkt alleen bij de dubbele en drievoudige kookzones

BEREIDINGSTABEL

RECEPT	FUNCTIE	VOORVER- WARMEN	TEMPERATUUR (°C)	DUUR (MIN)	NIVEAU EN ACCESSOIRES
Luchtig gebak		Ja	160 - 180	35 - 55	2 
		Ja	150 - 170	30 - 90	3 1  
Gevulde taarten (cheesecake, strudel, appeltaart)		Ja	150 - 190	30 - 85	2 
		Ja	150 - 190	35 - 90	3 1  
Koekjes / taartjes		Ja	170 - 180	15 - 40	3 
		Ja	150 - 175	20 - 45	3 1  
Soesjes		Ja	180	30 - 40	3 
		Ja	170 - 190	35 - 45	3 1  
Meringues		Ja	90	120 - 130	3 
		Ja	90	130 - 150	3 1  
Brood / pizza / focaccia		Ja	190 - 250	15 - 50	2 
		Ja	190 - 250	25 - 50	3 1  
Diepvriespizza's		Ja	250	10 - 15	2 
		Ja	250	10 - 20	3 1  
Hartige taarten (groentetaart, quiche)		Ja	175 - 200	40 - 50	2 
		Ja	175 - 190	50 - 65	3 1  
Pasteitjes / bladerdeeghapjes		Ja	180 - 200	20 - 30	3 
		Ja	175 - 200	25 - 45	3 1  
Lasagne / pasta uit de oven / cannelloni / ovenschotels		Ja	190 - 200	40 - 65	2 
Lamsvlees / kalfsvlees / rundvlees / varkensvlees 1 kg		Ja	190 - 200	90 - 110	2 
Kip/konijn/eend 1 kg		Ja	190 - 200	65 - 85	2 
Kalkoen/Gans 3 kg		Ja	190 - 200	140 - 180	1 / 2 
Lamsvlees / kalfsvlees / rundvlees / varkensvlees 1 kg		Ja	180 - 200	40 - 60	2 
Gebraden varkensvlees met korst 2 kg		Ja	175 - 200	50 - 60	2 
Kip/konijn/eend 1 kg		Ja	200	2 - 5	4 

FUNCTIES					
	Conventioneel	Grill	Gegrat. groenten	Hetelucht	Convectiebakken

ACCESSOIRES					
	Rooster	Taartvorm op rooster	Opvangbak/bakplaat of taartvorm op rooster	Druipplaat / Ovenschaal	Opvangbak met 500 ml water

RECEPT	FUNCTIE	VOORVER- WARMEN	TEMPERATUUR (°C)	DUUR (MIN)	NIVEAU EN ACCESSOIRES
Kalkoen/gans 3 kg		Ja	190 - 200	140 - 180	4 3  
Vis uit de oven/in folie (filet, heel)		Ja	180 - 200	40 - 60	2 
Gevulde groenten (tomaten, courgettes, aubergines)		Ja	175 - 200	50 - 60	2 
Toast		Ja	200	2 - 5	4 
Visfilet/moten vis		Ja	200	30 - 40 *	4 3  
Worstjes / spiezen / spareribs / hamburgers		Ja	200	30 - 50 *	4 3  
Gebraden kip 1 - 1,3 kg		-	200	55 - 70 *	2 1  
Rosbief rosé 1 kg		-	200	35 - 50 **	2 
Lamsbout / schenkel		-	200	60 - 90 **	2 
Geb. aardappelen		-	200	45 - 55 **	2 
Gegratin. groenten		-	200	20 - 30	2 
Lasagne en vlees		Ja	200	50 - 100 ***	3 1  
Vlees en aardappelen		Ja	200	45 - 100 ***	3 1  
Vis & Groenten		Ja	175	30 - 50 ***	3 1  











* Draai het vlees halverwege de bereidingstijd om.

** Draai het voedsel na twee derde van de bereidingstijd om (indien nodig).

*** Verwissel de steunhoogtes halverwege de bereiding.

**** Geschatte tijdsduur: Gerechten kunnen op verschillende tijdstippen afhankelijk van de persoonlijke voorkeur uit de oven worden verwijderd.

Download de Gids voor Gebruik en Onderhoud door naar de website docs.indesit.eu te gaan om de tabel van geteste recepten te raadplegen die zijn ingevuld voor de beoordelingsinstellingen in overeenstemming met de IEC 60350 - 1 standaard.

FUNCTIES	 Conventioneel	 Grill	 Gegrat. groenten	 Hetelucht	 Convectiebakken
ACCESSOIRES	 Rooster	 Taartvorm op rooster	 Ovangbak/bakplaat of taartvorm op rooster	 Druipplaat / Ovenschaal	 Ovangbak met 500 ml water

ONDERHOUD EN REINIGING



Download voor meer informatie de Gids voor Gebruik en Onderhoud op docs.whirlpool.eu

Zorg ervoor dat de oven afgekoeld is vooraleer te onderhouden of te reinigen. Gebruik geen stoomreinigers.

Gebruik geen staalwol, schuursponsjes of schurende/bijtende reinigingsproducten, omdat deze het oppervlak van het apparaat kunnen beschadigen.

Draag beschermende

handschoenen.

De oven moet worden losgekoppeld van het elektriciteitsnet voordat u onderhoudswerkzaamheden uitvoert.

EXTERNE OPPERVLAKKEN

Reinig de oppervlakken met een vochtig microvezeldoekje.

Als ze zeer vuil zijn, voeg dan een paar druppels neutraal afwasmiddel toe aan het water. Droog af met een droge doek.

Gebruik geen bijtende of schurende reinigingsmiddelen. Als een dergelijk product per ongeluk in contact komt met de oppervlakken het apparaat, verwijder het dan onmiddellijk met een vochtig microvezeldoekje.

INTERNE OPPERVLAKKEN

• Na elk gebruik moet de oven afkoelen en dan gereinigd worden, bij voorkeur wanneer die nog

warm is, om afzettingen of vlekken veroorzaakt door voedselresten te verwijderen.

Laat voor het drogen van condens die zich heeft gevormd vanwege het bereiden van voedsel met een hoog vochtgehalte de oven volledig afkoelen en veeg het af met een doek of spons. Maak de ruit schoon met een product voor glas

• Om de oven gemakkelijker te kunnen reinigen, kan de deur worden verwijderd.

ACCESSOIRES

Laat de accessoires na gebruik weken in water met afwasmiddel. Pak ze vast met handschoenen als ze nog heet zijn. Voedselresten kunnen met een afwasborstel of met een sponsje worden verwijderd.

VERVANGEN VAN HET LAMPJE

1. Koppel de oven los van de netvoeding.
2. Schroef het beschermkapje van de lamp, vervang de lamp en schroef het beschermkapje weer op de lamp.
3. Sluit de oven weer aan op de netvoeding.

Let op: Gebruik alleen gloeilampen van 25-40W/230V type E-14, T300°C, of halogeenlampen van 2040W/230 V type G9, T300°C. De lamp die in het product wordt gebruikt is specifiek ontworpen voor huishoudapparaten en is niet geschikt voor ruimteverlichting (EC-Richtlijn Nr. 244/2009). De lampjes zijn verkrijgbaar bij de Consumentenservice.

- Raak de halogeenlampen niet met blote handen aan omdat vingerafdrukken ze kunnen beschadigen. Gebruik de oven niet voordat het beschermkapje is teruggeplaatst.

DE DEUR VERWIJDEREN EN TERUGPLAATSEN

1. Om de deur te verwijderen opent u deze volledig en brengt u de vergrendelingen naar beneden totdat ze ontgrendeld zijn .

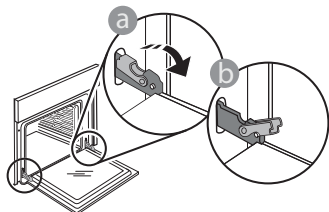

2. Sluit de deur zo ver mogelijk. Houd de deur stevig met beide handen beet – niet vasthouden aan de handgreep. Verwijder de deur door deze te blijven sluiten en tegelijkertijd omhoog te trekken totdat het loshaakt. Zet de deur opzij en laat deze op een zachte ondergrond rusten. Zet de deur opzij en laat deze op een zachte ondergrond rusten.

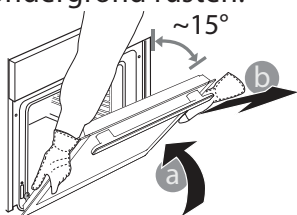

3. Monteer de deur opnieuw door deze te bewegen in de richting van de oven, de haken van de scharnieren uit te lijnen met de zitting en het bovenste deel op de zitting vast te zetten .

4. Laat de deur zakken en doe deze vervolgens volledig open. Breng de vergrendelingen omlaag naar hun oorspronkelijke positie: Zorg ervoor dat ze volledig naar beneden staan.

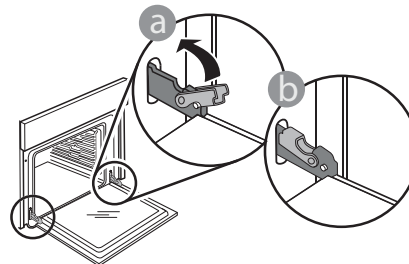

Zachtjes drukken, om te controleren of de vergrendelingen in de juiste positie staan.

5. Probeer de deur te sluiten en controleer of het in lijn met het bedieningspaneel is. Als dit niet het geval is herhaalt u de bovenstaande stappen: Als het niet goed werkt kan de deur beschadigd raken.

Probleem	Mogelijke oorzaak	Oplossing
De oven werkt niet.	Stroomonderbreking. Loskoppeling van het elektriciteitsnet.	Controleer of het elektriciteitsnet spanning heeft en of de oven is aangesloten. Zet de oven uit en weer aan, om te controleren of het probleem opgelost is.
Op de display verschijnt de letter "F" gevolgd door een nummer.	Softwareprobleem.	Neem contact op met de dichtstbijzijnde Consumentenservice en vermeld het nummer dat volgt op de letter "F".

NUTTIGE TIPS



Download voor meer informatie de Gids voor Gebruik en Onderhoud op docs.whirlpool.eu

LEZEN VAN DE BEREIDINGSTABEL

De tabel geeft een overzicht van de beste functie, accessoires en het niveau voor het bereiden van verschillende soorten gerechten. De bereidingstijden gelden vanaf het moment dat het gerecht in de oven wordt gezet, zonder de voorverwarmingstijd (indien nodig). De bereidingstemperaturen zijn bij benadering en zijn afhankelijk van de hoeveelheid voedsel en het type accessoire dat wordt gebruikt. Gebruik eerst de laagste aanbevolen waarden. Als de bereiding niet naar wens is, kunt u hogere waarden gebruiken. Geadviseerd wordt om de bijgeleverde accessoires te gebruiken en indien mogelijk taartvormen en bakplaten van donker metaal. U kunt ook vuurvaste of aardewerk pannen en accessoires gebruiken; de bereidingstijden zijn dan iets langer.

HET TEGELIJKERTIJD BEREIDEN VAN VERSCHILLENDE GERECHTEN

Met de functie "Hete Lucht" kunt u tegelijkertijd verschillende gerechten bereiden (bijvoorbeeld: vis en groenten) op verschillende steunhoogtes. Haal de gerechten die klaar zijn uit de oven en laat de gerechten die meer tijd nodig hebben in de oven staan.

PRODUCT

De productfiche met energiegegevens van dit apparaat kan gedownload worden van onze website docs.whirlpool.eu

HOE DE GIDS VOOR GEBRUIK EN ONDERHOUD TE VERKRIJGEN

> Download de Gids voor Gebruik en Onderhoud op onze website docs.whirlpool.eu (u kunt deze QR code gebruiken), onder vermelding van de handelscode van het product.



> U kunt ook contact opnemen met onze Consumentenservice.

CONTACT OPNEMEN MET CONSUMENTENSERVICE

Onze contactgegevens staan in de garantiehandleiding. Wanneer u contact opneemt met de Consumentenservice gelieve de codes te vermelden die op het identificatieplaatje van het apparaat staan.

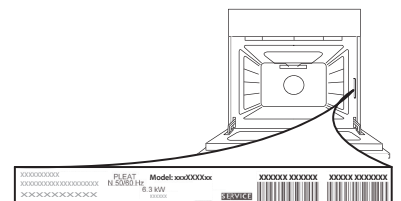

GUIDA RAPIDA



Scaricare le istruzioni per la sicurezza e le istruzioni per l'uso collegandosi al sito docs.whirlpool.eu e seguire la procedura indicata sul retro.

! Leggere attentamente le istruzioni per la sicurezza prima di utilizzare il prodotto.

DESCRIZIONE PRODOTTO

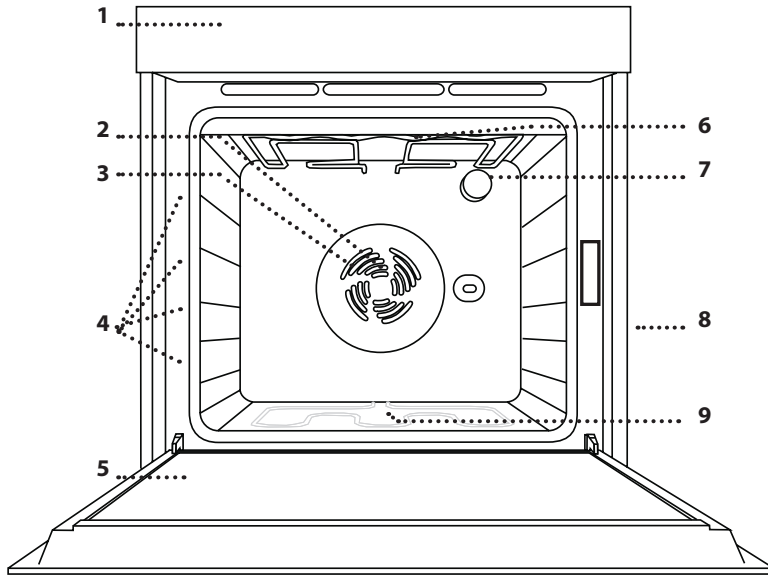

1. Pannello comandi
2. Ventola
3. Resistenza circolare (non visibile)
4. Griglie laterali (il livello è indicato sulla parte frontale del forno)
5. Porta
6. Resistenza superiore / grill
7. Lampada
8. Targhetta matricola (da non rimuovere)
9. Resistenza inferiore (non visibile)

PANNELLO DI CONTROLLO

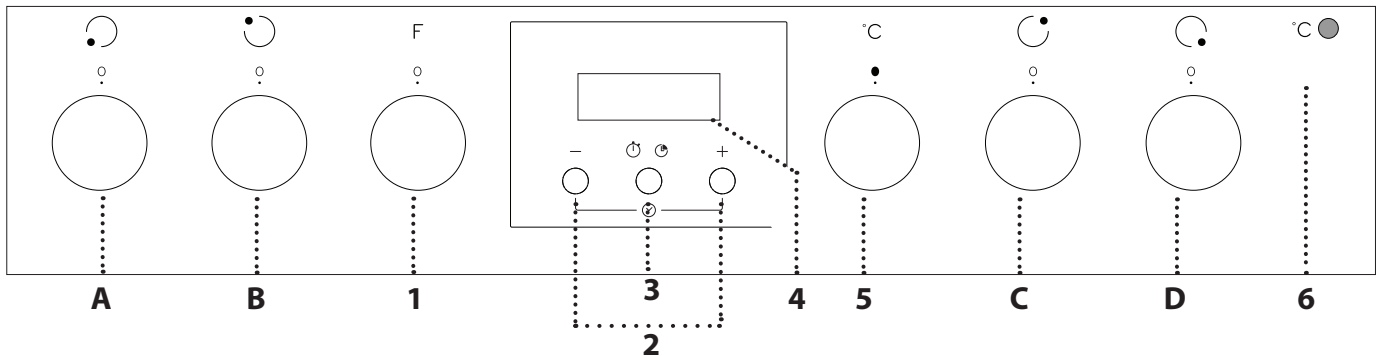

COMANDI FORNO

1. MANOPOLA DI SELEZIONE

Per accendere il forno selezionando una funzione. Ruotare sulla posizione **O** per disattivare il forno.

2. TASTO +/-

Per aumentare o diminuire il valore visualizzato sul display.

3. TASTO DI REGOLAZIONE DEL TEMPO

Per selezionare le impostazioni di : durata, timer.

4. DISPLAY

5. MANOPOLA TERMOSTATO

Ruotare per selezionare la temperatura desiderata.

6. SPIA TERMOSTATO/ PRERISCALDAMENTO

Si accende durante la fase di riscaldamento. Si spegne al raggiungimento della temperatura

desiderata.

MANOPOLE COMANDO PER PIANO COTTURA

- A. per zona di cottura anteriore sinistra.
- B. per zona di cottura posteriore sinistra.
- C. per zona di cottura posteriore destra.
- D. per zona di cottura anteriore destra.

Note: tutte le manopole sono a scomparsa. Fare pressione al centro delle stesse per estrarle dalla loro sede.

GRIGLIA

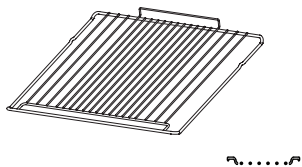

LECCARDA (SE PRESENTE)

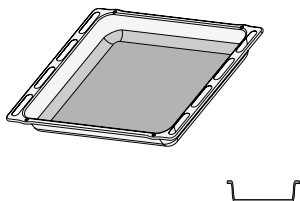

TEGLIA

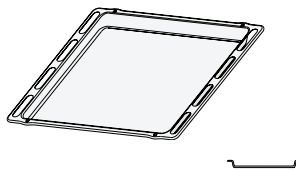

Il numero e il tipo di accessori possono variare a seconda del modello acquistato. È possibile acquistare separatamente altri accessori presso il Servizio Assistenza Clienti.

INSERIRE LA GRIGLIA E ALTRI ACCESSORI

- Inserire la griglia orizzontalmente facendola scivolare sulle griglie laterali inserendo dapprima il lato rialzato orientato verso l'alto.
- Gli altri accessori, come la leccarda o la piastra dolci, si inseriscono orizzontalmente come la griglia.

TOGLIERE E RIMONTARE LE GRIGLIE LATERALI

- Per rimuovere le griglie, togliere le viti di fissaggio (se presenti) da entrambi i lati con l'aiuto di una moneta o di un attrezzo adatto. Quindi sollevare le guide ed estrarre le parti inferiori dai relativi alloggiamenti: a questo punto è possibile rimuovere le griglie.
- Per rimontare le griglie, inserirle dapprima nelle sedi superiori. Avvicinarle alla cavità tenendo sollevato, quindi abbassarle in posizione nelle sedi inferiori. Rimontare le viti di fissaggio.

FUNZIONI



OFF

Per spegnere il forno.



LAMPADA

Per accendere/spegnere la luce del forno.



STATICO

Per cuocere qualsiasi tipo di pietanza su un solo ripiano.



HYDROCLEANING

Per eliminare lo sporco creato dalla cottura mediante un ciclo a bassa temperatura. L'azione del vapore rilasciato durante questo speciale ciclo di pulizia a bassa temperatura permette di rimuovere facilmente sporco e residui di cibo. Versare 200 ml di acqua potabile sul fondo del forno e attivare la funzione per 35' a 90°C. Attivare la funzione a forno freddo, dopo averlo lasciato raffreddare per 15'.



VENTILATO

Per cuocere carni e torte con ripieno liquido (salate o dolci) su un solo ripiano, pizze su singolo o doppio livello. Per le cotture su due livelli, invertire la posizione degli alimenti a metà cottura per ottenere un risultato più omogeneo.



GRILL

Per grigliare costate, spiedini e salsicce, gratinare verdure o dorare il pane. Per la grigliatura delle carni, si consiglia di utilizzare una teglia per raccogliere il liquido di cottura: posizionarla un livello sotto la griglia e aggiungere 500 ml di acqua potabile.



GRATIN

Per arrostitire grossi pezzi di carne (cosciotti, roast beef, polli). Si consiglia di utilizzare una teglia per raccogliere il liquido di cottura: posizionarla un livello sotto la griglia e aggiungere 500 ml di acqua potabile. Con questa funzione è possibile utilizzare il girarrosto, se presente.



SCONGELAMENTO

Per velocizzare lo scongelamento degli alimenti.



TURBOVENTILATO

Per ottenere cibi con una base croccante e una superficie soffice. Ideale per cuocere su singolo livello torte con composto liquido senza base precotta. Questa funzione è ideale anche per piatti pronti surgelati.



MULTILIVELLO

Per cuocere contemporaneamente su due ripiani alimenti, anche diversi, che richiedono medesima temperatura di cottura. La funzione permette di cuocere senza trasmissione di odori da un alimento all'altro.



INFERIORE

Per dorare le pietanze alla base. Questa funzione può anche essere utilizzata per le cotture lente, per ultimare la cottura di piatti molto liquidi (dolci o salate) o per addensare salse e condimenti.

PRIMO UTILIZZO

1. IMPOSTARE L'ORA

Alla prima accensione, è necessario impostare l'ora: sul display lampeggiano l'indicazione "AUTO" e le cifre "0.00".



Per impostare l'ora, premere contemporaneamente i tasti — e +: Impostare l'ora utilizzando i tasti + e —.

Note: Per posticipare l'ora, ad esempio dopo interruzioni di corrente prolungate, è necessario impostarla nuovamente

2. IMPOSTARE IL SUONO

Dopo aver selezionato i valori desiderati, premere il *tasto di regolazione del tempo*: Sul display viene visualizzato "ton 1".



Per scegliere il suono desiderato, premere il tasto —, quindi premere il *tasto di regolazione del tempo* per confermare.

3. RISCALDARE IL FORNO

Un nuovo forno può rilasciare degli odori dovuti alla lavorazione di fabbrica: questo è normale. Prima di cucinare gli alimenti è dunque raccomandato di riscaldare a vuoto il forno per rimuovere ogni odore. Rimuovere protezioni di cartone o pellicole trasparenti e togliere gli accessori dal forno. Scaldare il forno a 250 °C per un'ora, utilizzando preferibilmente la funzione "Ventilato". Durante questa procedura il forno deve essere vuoto.

Seguire le istruzioni a seguire per impostare correttamente la funzione.

Note: è opportuno ventilare la stanza durante e dopo il primo utilizzo.

USO QUOTIDIANO

1. SELEZIONARE UNA FUNZIONE

Per selezionare una funzione, ruotare la *manopola di selezione* in corrispondenza del simbolo della funzione desiderata.

2. AVVIARE UNA FUNZIONE

Per avviare la funzione selezionata, ruotare la *manopola termostato* per impostare la temperatura desiderata.

Per interrompere una funzione in qualsiasi momento, spegnere il forno, ruotare la *manopola di selezione* e la *manopola del termostato* su \bigcirc e \bullet .

3. PRERISCALDAMENTO

Quando si attiva questa funzione, la spia del termostato si accende per segnalare l'inizio della fase di preriscaldamento.

Alla fine del processo, la spia del termostato si spegne per indicare che il forno ha raggiunto la temperatura impostata: a questo punto, inserire gli alimenti e procedere alla cottura.

Note: inserire gli alimenti nel forno prima della fine del preriscaldamento può compromettere i risultati di cottura.

. PROGRAMMARE LA COTTURA

Dopo avere selezionato e attivato la funzione è possibile impostare la durata.



DURATA

Premere il *tasto di regolazione del tempo*: il simbolo  lampeggia.



Premere nuovamente il *tasto di regolazione del tempo*: il display visualizza DUR con a fianco la scritta AUTO.

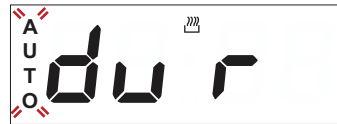

Impostare la durata usando i tasti + e —. Dopo qualche secondo, sul display viene visualizzata l'ora e l'indicazione AUTO rimane accesa per confermare l'impostazione.



Per visualizzare il tempo di cottura restante, premere il *tasto di regolazione del tempo* per almeno 2 secondi. Per modificarlo (se necessario), premere il *tasto* una seconda volta e usare i tasti + e — per modificare la durata.

A fine cottura, il simbolo  si spegne, viene emesso un segnale acustico e sul display lampeggia l'indicazione AUTO.



Premere un tasto qualsiasi per disattivare il segnale acustico.

Riportare la manopola funzioni e la manopola del termostato su 0 e ●, quindi premere il tasto di regolazione del tempo per almeno 2 secondi per spegnere il forno.

IMPOSTAZIONE DEL TIMER

Questa opzione non può essere utilizzata per interrompere o attivare la cottura ma permette di utilizzare il display come timer, sia quando è attiva una funzione che a forno spento.

Per attivare il timer, tenere premuto il tasto di regolazione del tempo: sul display lampeggia il simbolo .



Impostare la durata usando i tasti + e -: dopo alcuni secondi ha inizio il conto alla rovescia.



Il display mostra l'ora e il simbolo  rimane acceso per confermare che è stato impostato il timer.

Note: per visualizzare il conto alla rovescia ed eventualmente modificarlo, premere nuovamente il tasto di regolazione del tempo per almeno 2 secondi.

• FUNZIONAMENTO DEL PIANO COTTURA (vedere le istruzioni fornite con il piano cottura).

Ruotare in senso orario la manopola di comando della zona di cottura interessata fino a selezionare l'impostazione di potenza richiesta.

Il pannello comandi del forno è dotato di 4 manopole regolabili che controllano il funzionamento del piano. Le manopole comando del piano cottura sono contrassegnate da una scala numerica corrispondente ai differenti livelli di potenza e da una serie di simboli di funzione.

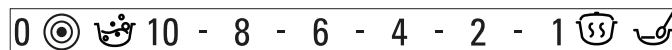

TEPORE

Per far lievitare la pasta, ammorbidire il burro tolto dal frigo, mantenere al caldo i biberon o la pappa dei bambini, per preparare lo yogurt, sciogliere il cioccolato, ecc. La funzione è disponibile soltanto con la spia del calore residui accesa. Per il funzionamento, accertarsi che la spia di calore residuo della zona di cottura che si desidera utilizzare sia accesa. Ruotare la manopola su . Per disattivare questa funzione, cambiare la posizione della manopola.

MANTENIMENTO CALORE

Per mantenere la temperatura costante a 60° fino a fine cottura. Per selezionare questa funzione, ruotare la manopola su .

EBOLLIZIONE RAPIDA



























































Per portare rapidamente l'acqua ad ebollizione; questa funzione resta attiva per un tempo prestabilito. Allo scadere del tempo, il piano di cottura ritorna automaticamente sul livello di potenza massimo. Può essere attivata anche a cottura già iniziata. **IMPORTANTE:** Prima di attivare questa funzione, accertarsi di aver messo la pentola sulla zona di cottura prescelta per evitare di danneggiare la superficie del piano. I valori di prestazione specificati per questa funzione sono garantiti per tutti i piani di cottura vetroceramici. Per il funzionamento, mettere la pentola sulla zona di cottura prescelta e ruotare la manopola su . Disattivare cambiando la posizione della manopola.

MULTIZONA

È disponibile sulle piastre anteriore sinistra e posteriore sinistra. Allarga l'area di riscaldamento del piano per permettere l'uso di pentole grandi, ovali o rettangolari. Per selezionare questa funzione: ruotare la manopola su  e aspettare che la spia di calore residuo corrispondente alla piastra inizi a lampeggiare. Per azionare la zona tripla (se disponibile), attendere fino a quando il LED inizia a lampeggiare velocemente. Selezionare il livello di potenza richiesta ruotando la manopola in senso antiorario. La spia di calore residuo resta accesa per indicare che il piano di cottura è inserito. Per deselezionare, ruotare in senso antiorario la manopola su 0.

Note: è possibile disattivare la funzione multizona soltanto su piani dotati da zona di cottura doppia e tripla

TABELLA DI COTTURA

RICETTA	FUNZIONE	PRERISCALDA- MENTO	TEMPERATURA (°C)	DURATA (MIN)	LIVELLO E ACCESSORI
Torte a lievitazione		Sì	160 - 180	35 - 55	2 
		Sì	150 - 170	30 - 90	3 1  
Torte ripiene (cheesecake, strudel, torta di mele)		Sì	150 - 190	30 - 85	2 
		Sì	150 - 190	35 - 90	3 1  
Biscotti / Crostatine		Sì	170 - 180	15 - 40	3 
		Sì	150 - 175	20 - 45	3 1  
Bignè		Sì	180	30 - 40	3 
		Sì	170 - 190	35 - 45	3 1  
Meringhe		Sì	90	120 - 130	3 
		Sì	90	130 - 150	3 1  
Pane / Pizza / Focaccia		Sì	190 - 250	15 - 50	2 
		Sì	190 - 250	25 - 50	3 1  
Pizze surgelate		Sì	250	10 - 15	2 
		Sì	250	10 - 20	3 1  
Torte salate (torta di verdura, quiche)		Sì	175 - 200	40 - 50	2 
		Sì	175 - 190	50 - 65	3 1  
Vols-au-vent / Salatini di pasta sfoglia		Sì	180 - 200	20 - 30	3 
		Sì	175 - 200	25 - 45	3 1  
Lasagna / Pasta al forno / Cannelloni / Sfornati		Sì	190 - 200	40 - 65	2 
Agnello / Vitello / Manzo / Maiale (1 kg)		Sì	190 - 200	90 - 110	2 
Pollo / Coniglio / Anatra 1 kg		Sì	190 - 200	65 - 85	2 
Tacchino / Oca (3 kg)		Sì	190 - 200	140 - 180	1 / 2 
Agnello / Vitello / Manzo / Maiale 1 kg		Sì	180 - 200	40 - 60	2 
Arrosto di maiale con cotenna 2kg		Sì	175 - 200	50 - 60	2 
Pollo / Coniglio / Anatra 1 kg		Sì	200	2 - 5	4 

FUNZIONI	 Statico	 Grill	 Gratin	 Termoventilato	 Ventilato
ACCESSORI	 Griglia	 Tortiera su griglia	 Leccarda / piastra dolci o tortiera su griglia	 Leccarda / Piastra dolci	 Leccarda con 500 ml di acqua

RICETTA	FUNZIONE	PRERISCALDA- MENTO	TEMPERATURA (°C)	DURATA (MIN)	LIVELLO E ACCESSORI
Tacchino / Oca 3 kg		Sì	190 - 200	140 - 180	4 3
Pesce al forno / al cartoccio (filetti, intero)		Sì	180 - 200	40 - 60	2
Verdure ripiene (pomodori, zucchine, melanzane)		Sì	175 - 200	50 - 60	2
Toast		Sì	200	2 - 5	4
Filetti/Tranci di pesce		Sì	200	30 - 40 *	4 3
Salsicce / Spiedini / Costine / Hamburger		Sì	200	30 - 50 *	4 3
Pollo arrosto 1-1,3 kg		-	200	55 - 70 *	2 1
Roast beef al sangue 1 kg		-	200	35 - 50 **	2
Cosciotto d'agnello/Stinco		-	200	60 - 90 **	2
Patate arrosto		-	200	45 - 55 **	2
Verdure gratinate		-	200	20 - 30	2
Lasagne e carne		Sì	200	50 - 100 ***	3 1
Carne e patate		Sì	200	45 - 100 ***	3 1
Pesce e verdure		Sì	175	30 - 50 ***	3 1

* Ruotare il cibo a metà cottura.

**Ruotare il cibo a due terzi di cottura se necessario.

*** Invertire i livelli a metà cottura.

**** La durata è approssimata: le pietanze possono essere tolte dal forno in tempi differenti secondo preferenza.

Scaricare le Istruzioni per l'uso dal sito docs.indesit.eu per consultare la tabella delle ricette testate, compilata per gli istituti di valutazione secondo la norma CEI 60350- 1.

FUNZIONI					
	Statico	Grill	Gratin	Termoventilato	Ventilato
ACCESSORI					
	Griglia	Tortiera su griglia	Leccarda / piastra dolci o tortiera su griglia	Leccarda / Piastra dolci	Leccarda con 500 ml di acqua

CURA E PULIZIA



Per maggiori informazioni, scaricare le istruzioni per l'uso da docs.whirlpool.eu

Assicurarsi che il forno si sia raffreddato prima di eseguire ogni operazione.

Non utilizzare pulitrici a getto di vapore.

Non usare pagliette metalliche, panni abrasivi e detergenti abrasivi o corrosivi che possano danneggiare le superfici.

Utilizzare guanti protettivi.

Il forno deve essere disconnesso dalla rete elettrica prima di effettuare operazioni di manutenzione.

SUPERFICI ESTERNE

Pulire le superfici con un panno in microfibra umido. Se molto sporche, aggiungere qualche goccia di detergente neutro. Asciugare con un panno asciutto. Non usare detergenti corrosivi o abrasivi. Se inavvertitamente uno di questi prodotti dovesse venire a contatto con le superfici, pulire subito con un panno in microfibra umido.

SUPERFICI INTERNE

• Dopo ogni uso, lasciare raffreddare il forno e pulirlo preferibilmente quando è ancora tiepido per rimuovere incrostazioni e macchie dovute a residui di cibo.

- Per asciugare la condensa dovuta alla cottura di alimenti ad alto contenuto di acqua, usare a forno freddo un panno o una spugna. Pulire il vetro nella porta con detergente liquido di tipo adatto
- Per facilitare la pulizia della porta è possibile rimuoverla.

ACCESSORI

Mettere a bagno gli accessori con detersivo per piatti dopo l'uso, maneggiandoli con guanti da forno, se ancora caldi. I residui di cibo possono essere rimossi con una spazzola per piatti o con una spugna.

SOSTITUZIONE DELLA LAMPADINA

1. Scollegare il forno dalla rete elettrica.
2. Svitare la copertura della lampada, sostituire la lampada e avvitarla di nuovo il coperchio della lampada.
3. Ricollegare il forno alla rete elettrica.

Note: Usare solo lampade ad incandescenza da 25-40W/230V tipo E-14, T300°C, o lampade alogene da 20-40W/230 V tipo G9, T300°C. La lampada utilizzata nel prodotto è specifica per elettrodomestici e non è adatta per l'illuminazione di ambienti domestici (Regolamento (CE) 244/2009). Le lampade sono disponibili presso il Servizio Assistenza.

- In caso di impiego di lampade alogene, non maneggiarle a mani nude, per evitare che vengano danneggiate dalle impronte digitali. Non far funzionare il forno senza prima aver riposizionato il coperchio.

TOGLIERE E RIMONTARE LA PORTA

1. Per rimuovere la porta, aprirla completamente e abbassare i fermi fino alla posizione di sblocco.

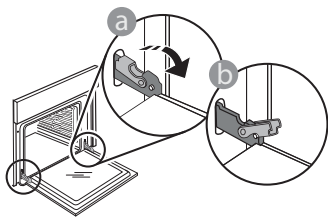

2. Chiudere la porta fino a quando è possibile. Prendere saldamente la porta con entrambe le mani, evitando di tenerla per la maniglia. Per estrarla facilmente, continuare a chiuderla e contemporaneamente tirarla verso l'alto finché non esce dalle sedi. Togliere la porta e appoggiarla su un piano morbido.

Togliere la porta e appoggiarla su un piano morbido.

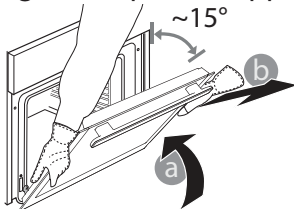

3. Per rimontare la porta, avvicinarla al forno allineando i ganci delle cerniere alle proprie sedi e ancorare la parte superiore agli alloggiamenti.

4. Abbassare la porta e poi aprirla completamente. Abbassare i fermi nella posizione originale: fare attenzione che siano completamente abbassati.

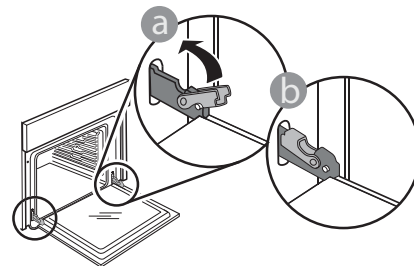

Sarà necessario applicare una leggera pressione per assicurare il corretto posizionamento dei fermi.

5. Provare a chiudere la porta, verificando che sia allineata al pannello di controllo. Se non lo fosse, ripetere tutte le operazioni: funzionando male, la porta potrebbe danneggiarsi.



Problema	Possibile causa	Soluzione
Il forno non funziona.	Interruzione di corrente elettrica. Disconnessione dalla rete principale.	Verificare che ci sia tensione in rete e che il forno sia collegato all'alimentazione elettrica. Spegnere e riaccendere il forno e verificare se l'inconveniente persiste.
Il display mostra la lettera "F" seguita da un numero.	Problema software.	Contattare il più vicino Servizio Assistenza Clienti e specificare il numero che segue la lettera "F".

CONSIGLI UTILI



Per maggiori informazioni, scaricare le istruzioni per l'uso da docs.whirlpool.eu

COME LEGGERE LA TABELLA DI COTTURA

La tabella indica la funzione, gli accessori e il livello migliore da utilizzare per cuocere svariati tipi di cibo. I tempi di cottura si riferiscono all'introduzione del cibo nel forno, escluso il preriscaldamento (dove richiesto).

Le temperature e i tempi di cottura sono indicativi e dipendono dalla quantità di cibo e dal tipo di accessori. Utilizzare inizialmente i valori più bassi consigliati e, se il risultato della cottura non è quello desiderato, passare a quelli più alti. Si consiglia di utilizzare gli accessori in dotazione e tortiere o teglie possibilmente in metallo scuro. È possibile utilizzare anche pentole e accessori in pirex o in ceramica, i tempi di cottura si allungheranno leggermente.

CUCINARE DIFFERENTI ALIMENTI CONTEMPORANEAMENTE

Utilizzando la funzione "Termoventilato", è possibile cuocere contemporaneamente cibi diversi (ad esempio: pesce e verdure), su ripiani diversi. Estrarre i cibi che richiedono tempi di cottura inferiori e lasciare continuare la cottura per quelli con tempi più lunghi.

SCHEMA TECNICA

 La scheda tecnica del prodotto con i dati energetici dell'apparecchio può essere scaricata dal sito Internet docs.whirlpool.eu

COME OTTENERE LE ISTRUZIONI PER L'USO

>  Scaricare le Istruzioni per l'uso dal sito web docs.whirlpool.eu (è possibile utilizzare il presente codice QR), specificando il codice prodotto.



> In alternativa, contattare il Servizio di Assistenza Clienti.

CONTATTARE IL SERVIZIO ASSISTENZA CLIENTI

I contatti possono essere trovati sul manuale di garanzia. Quando si contatta il Servizio Assistenza fornire i codici presenti sulla targhetta matricola del prodotto.

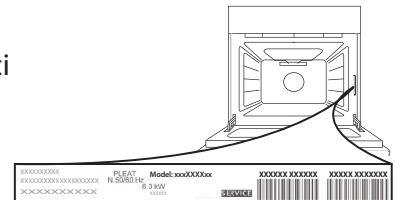

400011603916/B

GUÍA DE CONSULTA DIARIA



Puede descargar las Instrucciones de seguridad y la Guía de uso y cuidado en nuestro sitio web docs.whirlpool.eu siguiendo las instrucciones del dorso de este documento.



Antes de utilizar por primera vez el aparato lea detenidamente la guía de Higiene y seguridad.

DESCRIPCIÓN DEL PRODUCTO

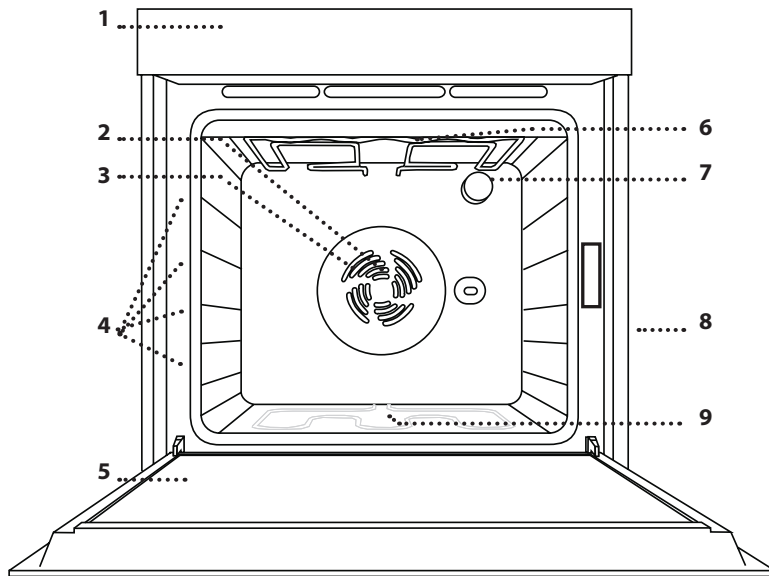

1. Panel de mandos
2. Ventilador
3. Resistencia circular (no visible)
4. Guías para estantes (el nivel está indicado en la parte frontal del horno)
5. Puerta
6. Resistencia superior / grill
7. Lámpara
8. Placa de características (no debe retirarse)
9. Resistencia inferior (no visible)

PANEL DE CONTROL

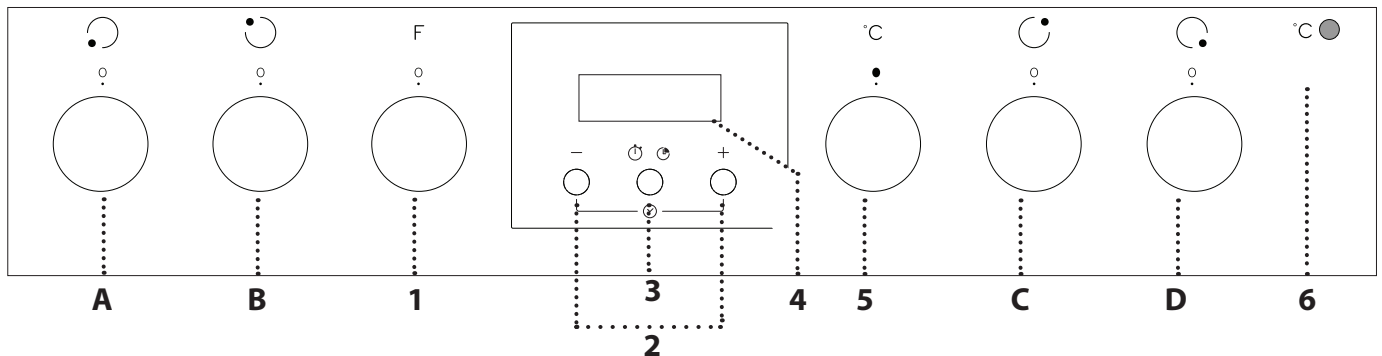

MANDOS DEL HORNO

1. SELECTOR

Para encender el horno seleccionando una función. Póngalo en la posición **O** para apagar el horno.

2. +/- BOTÓN

Para disminuir o aumentar el valor que se muestra en la pantalla.

3. BOTÓN HORARIO

Para seleccionar los distintos ajustes: duración, temporizador.

4. PANTALLA

5. SELECTOR DEL TERMOSTATO / PRECALENTAMIENTO

Gire para seleccionar la temperatura deseada.

6. LED TERMOSTATO/ PRECALENTADO

Se enciende durante el proceso de calentamiento. Se apaga cuando se alcanza la temperatura deseada.

SELECTORES DE CONTROL DE LA SUPERFICIE DE COCCIÓN

- A. de la placa frontal izquierda.
- B. de la placa trasera izquierda.
- C. de la placa trasera derecha.
- D. de la placa frontal derecha.

Nota: todos los selectores son retráctiles. Presione en el centro para extraerlos de su alojamiento.

REJILLA

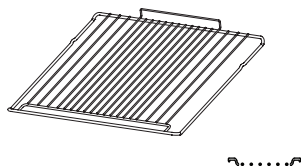

GRASERA (SI ESTÁ PREVISTA)

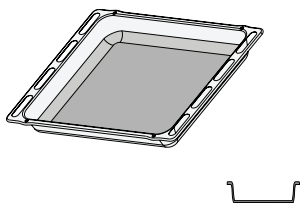

BANDEJA PASTELERA

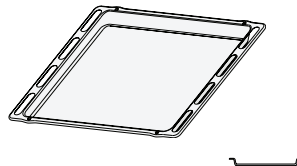

El número de accesorios puede variar de un modelo a otro. Se pueden adquirir otros accesorios por separado en el Servicio Postventa.

INTRODUCCIÓN DE LA REJILLA Y OTROS ACCESORIOS

- Introduzca la rejilla horizontalmente deslizándola por las guías y asegúrese de que el lado con el borde elevado quede mirando hacia arriba.
- Otros accesorios, como la grasera y la bandeja pastelera, se introducen horizontalmente igual que la rejilla.

CÓMO EXTRAER Y VOLVER A COLOCAR LAS GUÍAS PARA ESTANTES

- Para extraer las guías para estantes, retire los tornillos de fijación situados a ambos lados (si los hay) con la ayuda de una moneda o una herramienta. Levante las guías y saque las partes inferiores de sus alojamientos. Ahora puede extraer las guías.
- Para volver a colocar las guías para estantes, primero colóquelas en su alojamiento superior. Manteniéndolas en alto, deslícelas en el compartimento de cocción, y luego bájelas hasta colocarlas en el alojamiento inferior. Vuelva a colocar los tornillos de fijación.

FUNCIONES

OFF
Sirve para apagar el horno.

LUZ
Para encender/apagar la bombilla interior del horno.

CONVENCIONAL
Para cocinar cualquier tipo de alimento en un estante.

HYDROCLEANING
Para eliminar la suciedad generada por la cocción mediante un ciclo a baja temperatura. La acción del vapor liberado durante este ciclo especial de limpieza a baja temperatura permite eliminar la suciedad y los residuos de alimentos con facilidad. Vierta 200 ml de agua potable en el fondo del horno y utilice la función durante 35' a 90 °C. Active la función con el horno frío y déjelo enfriar durante 15' una vez terminado el ciclo.

HORNO DE CONVECCIÓN
Para cocinar carnes o tartas con relleno líquido (dulces o saladas) en un solo estante y pizzas en uno o dos estantes. En caso de cocinar en dos niveles, invierta la posición de los alimentos para obtener una cocción más homogénea.

GRILL
Para asar filetes, pinchos morunos y salchichas, cocinar verduras al gratin o tostar pan. Cuando ase carne, le recomendamos colocar la bandeja debajo para recoger los jugos de la cocción: Coloque el recipiente en cualquiera de los niveles debajo de la rejilla y añada 500 ml de agua potable.

GRATIN
Para asar grandes piezas de carne (pierna de cordero, rosbif, pollo). Le recomendamos utilizar la bandeja para recoger los jugos de la cocción: Coloque el recipiente en cualquiera de los niveles debajo de la rejilla y añada 500 ml de agua potable. El asador giratorio (si lo hay) puede utilizarse con esta función.

DESCONGELAR
Para acelerar la descongelación de los alimentos.

TURBO + VENTILADOR
Con esta función la comida queda con la base crujiente y la parte de arriba blanda. Es ideal para hornear pasteles con un relleno líquido y una base no precocinada en un solo estante. Esta función es ideal para alimentos precocinados congelados.

MULTINIVEL
Para cocinar simultáneamente en dos estantes diferentes alimentos que requieran la misma temperatura de cocción. Esta función puede utilizarse para cocinar diferentes alimentos sin que se mezclen los olores.

RESISTENCIA INFERIOR
Para dorar el fondo de las comidas. Esta función también se puede utilizar para la cocción lenta, para terminar de cocinar platos muy líquidos (dulces o salados) o espesar salsas.

PRIMER USO

1. AJUSTE DE LA HORA

La primera vez que encienda el aparato, tendrá que ajustar la hora: en la pantalla parpadean «AUTO» y «0.00».



Para ajustar la hora, pulse los botones $-$ y $+$ al mismo tiempo: Ajuste la hora con los botones $+$ y $-$.

Nota: Para cambiar la hora posteriormente, por ejemplo después de un corte de suministro prolongado, tendrá que volver a configurar la hora

2. AJUSTE DEL TONO

Una vez seleccionada la hora deseada, pulse el *botón horario*: La pantalla muestra «ton 1».



Para seleccionar el tono deseado, pulse el botón $-$, después pulse el *botón horario* para confirmar.

3. CALENTAR EL HORNO

Un horno nuevo puede liberar olores que se han quedado impregnados durante la fabricación: es completamente normal. Antes de empezar a cocinar, le recomendamos calentar el horno en vacío para eliminar cualquier olor.

Quite todos los cartones de protección o el film transparente del horno y saque todos los accesorios de su interior. Caliente el horno a 250 °C durante aproximadamente una hora, preferiblemente utilizando la función «Horno de convección». Durante este tiempo, el horno debe permanecer vacío. Siga las instrucciones para configurar la función correctamente.

Nota: Es aconsejable ventilar la habitación después de usar el aparato por primera vez.

USO DIARIO

1. SELECCIONAR UNA FUNCIÓN

Para seleccionar una función, gire el *selector* hasta el símbolo de la función deseada.

2. ACTIVAR UNA FUNCIÓN

Para iniciar la función seleccionada, gire el *selector del termostato* hasta la temperatura deseada.

Para interrumpir la función en cualquier momento, apague el horno, gire *selector* y el *selector del termostato* a O y \bullet .

3. PRECALENTAMIENTO

Una vez activada la función, el led del termostato se encenderá para indicar que el proceso de precalentamiento se ha iniciado.

Al final del proceso, el led del termostato se apaga indicando que el horno ha alcanzado la temperatura programada: en ese momento, coloque los alimentos dentro y proceda con la cocción.

Nota: Colocar los alimentos en el horno antes de que haya finalizado el precalentado puede tener efectos adversos en el resultado final de la cocción.

. COCCIÓN PROGRAMADA

Una vez seleccionada y activada la función, se puede ajustar los valores de duración.

 DURACIÓN

Pulse el *botón horario*: el símbolo  parpadea.



Vuelva a pulsar el *botón horario*: en la pantalla aparece DUR y, a continuación, AUTO.

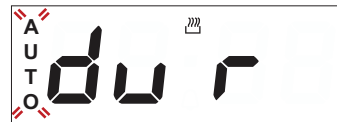

Ajuste la duración con los botones $+$ y $-$. Al cabo de unos segundos, la pantalla muestra la hora y AUTO permanece encendido, confirmando el ajuste.



Para ver el tiempo de cocción restante pulse el botón horario durante al menos 2 segundos. Para cambiarlo, si es necesario, vuelva a pulsarlo, con los botones $+$ y $-$ para modificar la duración.

Al finalizar la cocción, el símbolo  se apaga, suena una alarma y **AUTO** parpadea en la pantalla.



Pulse cualquier botón para desactivar la alarma. Vuelva a poner el selector de funciones y el *selector del termostato* en **O** y ●, después pulse el *botón horario* durante al menos 2 segundos para apagar el horno.

AJUSTE DEL TEMPORIZADOR

Esta opción no interrumpe ni activa la cocción, pero le permite utilizar la pantalla como temporizador, tanto si la función está activada como si el horno está apagado.

Para activar el temporizador, mantenga pulsado el *botón horario*: en la pantalla parpadea el símbolo .



Ajuste la duración con los botones + y -: la cuenta atrás se inicia al cabo de unos segundos.



La pantalla muestra la hora y la  permanece encendida, confirmando que se ha ajustado el temporizador.

Nota: Para ver la cuenta atrás y cambiarla si es necesario, pulse de nuevo el *botón horario* durante 2 segundos.

• **FUNCIONAMIENTO DE LA SUPERFICIE DE COCCIÓN** (vea las instrucciones suministradas con la superficie de cocción).

Gire el selector de la placa correspondiente hacia la derecha hasta la configuración de potencia deseada.

El panel de control del horno dispone de cuatro selectores ajustables para el funcionamiento de la superficie de cocción. Los selectores de la superficie de cocción están marcados con una escala numérica correspondiente a las distintas configuraciones de potencia y con una serie de símbolos de funciones.

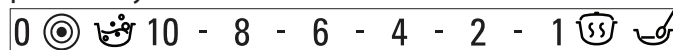

CALOR SUAVE

Para dejar que suba la masa, ablandar mantequilla sacada del frigorífico, mantener biberones o comida calientes y también para hacer yogur, derretir chocolate, etc. Esta función solo está disponible cuando el indicador de calor residual esté encendido. Para esta función, asegúrese de que el indicador de calor residual de la placa deseada esté encendido. Gire el selector a . Para deseleccionar la función, cambie la posición del selector.

MANTENIMIENTO DEL CALOR

Para mantener una temperatura constante de 60 ° hasta el final de la cocción. Para seleccionar esta función, gire el selector a .

COCCIÓN RÁPIDA



























































Esta función se usa para hervir agua rápidamente y permanece encendida durante un tiempo predefinido. Al terminar el tiempo predefinido, la superficie de cocción volverá automáticamente a la configuración de potencia máxima. Esta función puede activarse incluso durante la cocción. Importante: antes de seleccionar esta función, asegúrese de que la olla está situada en la placa seleccionada para evitar daños a la superficie de cocción. Los valores de rendimiento indicados para esta función son los que se garantizan para todas las superficies de cocción vitrocerámicas. Para utilizar esta función, sitúe la olla en la placa seleccionada y gire el selector a . Para deseleccionarla, cambie la posición del selector.

MULTIZONAS





Disponible en la placa frontal izquierda y en la trasera izquierda. Extiende el área de calentamiento de la superficie de cocción para permitir el uso de ollas o recipientes de cocción de gran tamaño y de forma oval o rectangular. Para seleccionar esta función: gire el mando a  y espere a que el indicador de calor residual de la placa empiece a parpadear. Para encender la función de zona triple (si está disponible), espere a que el led empiece a parpadear rápidamente. Seleccione la configuración de potencia deseada girando el selector hacia la izquierda. El indicador de calor residual permanecerá encendido para indicar que la superficie de cocción está en uso. Para deseleccionarla, coloque el selector en 0 girándolo hacia la izquierda.

Nota: La función multizona solo puede encenderse en las placas dobles y triples de la superficie de cocción

TABLA DE COCCIÓN

RECETA	FUNCIÓN	PRECALENTAR	TEMPERATURA (°C)	DURACIÓN (MIN)	NIVEL Y ACCESORIOS
Bizcochos		Sí	160 - 180	35-55	2 
		Sí	150 - 170	30 - 90	3 1  
Bizcocho relleno (tarta de queso, pasteles de hojaldre relleno, tarta de manzana)		Sí	150 -190	30-85	2 
		Sí	150 - 190	35 - 90	3 1  
Galletas/tartaletas		Sí	170 - 180	15 - 40	3 
		Sí	150 - 175	20 - 45	3 1  
Lionesas		Sí	180	30 - 40	3 
		Sí	170 - 190	35 - 45	3 1  
Merengues		Sí	90	120 - 130	3 
		Sí	90	130-150	3 1  
Pan, pizza, focaccia		Sí	190 - 250	15 - 50	2 
		Sí	190 - 250	25 - 50	3 1  
Pizza congelada		Sí	250	10 - 15	2 
		Sí	250	10 - 20	3 1  
Tartas saladas (tarta de verduras, quiche)		Sí	175 - 200	40 - 50	2 
		Sí	175 - 190	50 - 65	3 1  
Volovanes/Canapés de hojaldre		Sí	180 - 200	20 - 30	3 
		Sí	175 - 200	25 - 45	3 1  
Lasaña / pasta al horno / canelones / budines		Sí	190 - 200	40 - 65	2 
Cordero/Tertera/Buey/Cerdo 1 kg		Sí	190 - 200	90 - 110	2 
Pollo, conejo, pato (1 kg)		Sí	190 - 200	65 - 85	2 
Pavo, oca (3 kg)		Sí	190 - 200	140 - 180	1/2 
Cordero/ternera/buey/cerdo 1 kg		Sí	180 - 200	40-60	2 
Cerdo asado con piel 2 kg		Sí	175 - 200	50 - 60	2 
Pollo/conejo/pato 1 kg		Sí	200	2 - 5	4 

FUNCIÓNES					
	Convencional	Grill	Gratín	Aire forzado	Horno de convección

ACCESORIOS					
	Rejilla	Molde sobre rejilla	Grasera, bandeja pastelera o molde sobre rejilla	Grasera / Bandeja pastelera	Grasera con 500 ml de agua

RECETA	FUNCIÓN	PRECALENTAR	TEMPERATURA (°C)	DURACIÓN (MIN)	NIVEL Y ACCESORIOS
Pavo/oca 3 kg		Sí	190 - 200	140 - 180	4 3
Pescado al horno/en papillote (filetes, entero)		Sí	180 - 200	40-60	2
Verduras rellenas (tomates, calabacines, berenjenas)		Sí	175 - 200	50 - 60	2
Tostada		Sí	200	2 - 5	4
Filetes de pescado/de carne		Sí	200	30 - 40 *	4 3
Salchichas/brochetas/costillas/hamburguesas		Sí	200	30 - 50 *	4 3
Pollo asado 1-1,3 kg		-	200	55 - 70 *	2 1
Rosbif poco hecho 1 kg		-	200	35 - 50 **	2
Pierna de cordero/cerdo		-	200	60 - 90 **	2
Patatas al horno		-	200	45 - 55 **	2
Verduras gratinadas		-	200	20 - 30	2
Lasañas y carnes		Sí	200	50-100 ***	3 1
Carnes y patatas		Sí	200	45 - 100 ***	3 1
Pescado y verduras		Sí	175	30-50 ***	3 1

* Dar la vuelta al alimento a mitad de la cocción.

** Darle la vuelta al alimento en el segundo tercio de la cocción (si fuera necesario).

*** Cambiar de nivel a mitad de la cocción.

**** Tiempo de cocción estimado: Los platos se pueden extraer del horno antes o después según los gustos personales.

Descargue la Guía de uso y cuidado en docs.indesit.eu para consultar la tabla de recetas probadas, cumplimentada para las autoridades de certificación de conformidad con la norma IEC 60350-1.

FUNCIONES					
	Convencional	Grill	Gratín	Aire forzado	Horno de convección

ACCESORIOS					
	Rejilla	Molde sobre rejilla	Grasera, bandeja pastelera o molde sobre rejilla	Grasera / Bandeja pastelera	Grasera con 500 ml de agua

LIMPIEZA Y MANTENIMIENTO



Descargue la Guía de uso y cuidado en docs.whirlpool.eu para más información

Asegúrese de que el horno se haya enfriado antes de llevar a cabo las tareas de mantenimiento o limpieza.

No utilice aparatos de limpieza con vapor.

No utilice estropajos de acero, estropajos abrasivos ni productos de limpieza abrasivos/corrosivos, ya que podrían dañar las superficies del aparato.

Utilice guantes de protección.

El horno debe desconectarse de la red eléctrica antes de llevar a cabo cualquier trabajo de mantenimiento.

SUPERFICIES EXTERIORES

Limpie las superficies con un paño húmedo de microfibra.

Si están muy sucias, añada unas gotas de detergente neutro al agua. Seque con un paño seco.

No utilice detergentes corrosivos ni abrasivos. Si uno de esos productos entra accidentalmente en contacto con la superficie del aparato, límpielo de inmediato con un paño húmedo de microfibra.

SUPERFICIES INTERIORES

• Después de cada uso deje que el horno se enfríe y, a continuación, límpielo, preferiblemente cuando

aún esté tibio, para quitar los restos o las manchas causadas por los residuos de los alimentos. Para secar la condensación que se haya podido formar debido a la cocción de alimentos con un alto contenido en agua, deje que el horno se enfríe por completo y límpielo con un paño o esponja

- Para limpiar el horno con facilidad, quite la puerta .

ACCESORIOS

Después del uso, sumerja los accesorios en una solución líquida con detergente, utilizando guantes si aún están calientes. Los residuos de alimentos pueden quitarse con un cepillo o esponja.

SUSTITUCIÓN DE LA BOMBILLA

1. Desconecte el horno de la red eléctrica.
2. Desenrosque la tapa de la lámpara, sustituya la bombilla y vuelva a enroscar la tapa de la lámpara.
3. Vuelva a conectar el horno a la red eléctrica.

Nota: Utilice sólo bombillas incandescentes de 25-40W/230V tipo E-14, T300 °C o bombillas halógenas de 20-40W/230 V tipo G9, T300 °C. La bombilla que se usa en el aparato está diseñada específicamente para electrodomésticos y no es adecuada para la iluminación general de estancias de una vivienda (Normativa CE 244/2009). Las bombillas están disponibles en nuestro Servicio Postventa.

- Si utiliza bombillas halógenas, no las toque con las manos desnudas ya que las huellas dactilares podrían dañarlas. No utilice el horno hasta que no haya vuelto a colocar la tapa de la lámpara.

EXTRACCIÓN E INSTALACIÓN DE LA PUERTA

1. Para quitar la puerta, ábrala por completo y baje los pestillos hasta que estén en posición desbloqueada.

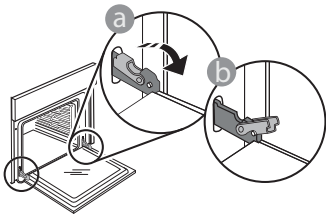

2. Cierre la puerta tanto como pueda. Sujete bien la puerta con las dos manos; no la sujete por el asa.

Simplemente extraiga la puerta continuando cerrándola y a la vez levantándola hasta que se salga de su alojamiento. Ponga la puerta en un lado, apoyada sobre una superficie blanda. Ponga la puerta en un lado, apoyada sobre una superficie blanda.

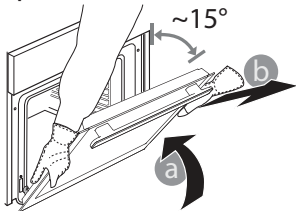

3. Vuelva a instalar la puerta llevándola hacia el horno, alineando los ganchos de las bisagras con sus alojamientos y fijando la parte superior en su alojamiento.

4. Baje la puerta y ábrala por completo. Baje los pestillos hasta su posición original: Asegúrese de haberlos bajado por completo.

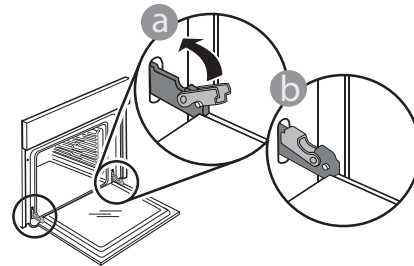

Presione suavemente para comprobar que los pestillos estén en la posición correcta.

5. Intente cerrar la puerta y compruebe que está alineada con el panel de control. Si no lo está, repita los pasos de arriba: La puerta podría dañarse si no funciona correctamente.



Problema	Posible causa	Solución
El horno no funciona.	Corte de suministro. Desconexión de la red eléctrica.	Compruebe que haya corriente eléctrica en la red y que el horno esté enchufado a la toma de electricidad. Apague el horno y vuelva a encenderlo para comprobar si se ha solucionado el problema.
En la pantalla aparecerá la letra «F» seguida de un número.	Problema de software.	Póngase en contacto con el Servicio Postventa más cercano e indique el número que aparece detrás de la letra «F».

CONSEJOS ÚTILES



Descargue la Guía de uso y cuidado en docs.whirlpool.eu para más información

CÓMO UTILIZAR LA TABLA DE COCCIÓN

La tabla indica la mejor función, accesorios y nivel para cocinar los diferentes tipos de alimentos. Los tiempos de cocción inician en el momento en que se coloca el alimento en el horno, excluyendo el precalentamiento (cuando sea necesario). Las temperaturas y los tiempos de cocción son orientativos y dependen de la cantidad de alimentos y del tipo de accesorio utilizado. En principio, aplique los valores de ajuste recomendados más bajos y, si la cocción no es suficiente, aumentelos. Utilice los accesorios suministrados y, si es posible, moldes y bandejas de horneado metálicos y de color oscuro. También puede utilizar recipientes y accesorios tipo pírex o de cerámica, aunque deberá tener en cuenta que los tiempos de cocción serán ligeramente mayores.

COCCIÓN DE VARIOS ALIMENTOS A LA VEZ

El uso de la función «Aire forzado» permite cocinar al mismo tiempo distintos alimentos que requieran la misma temperatura (por ejemplo: pescado y verduras), utilizando estantes diferentes. Retire del horno los alimentos que requieran menor tiempo de cocción y deje los que necesiten una cocción más prolongada.

FICHA DEL PRODUCTO

La ficha del producto con los datos de energía de este aparato se puede descargar en el sitio web docs.whirlpool.eu

CÓMO OBTENER LA GUÍA DE USO Y CUIDADO

> Descargue la Guía de uso y cuidado en nuestro sitio web docs.whirlpool.eu (puede utilizar este código QR), especificando el código comercial del producto.



> También puede ponerse en contacto con nuestro Servicio Postventa.

CÓMO PONERSE EN CONTACTO CON NUESTRO SERVICIO POSTVENTA

Encontrará nuestros datos de contacto en el manual de garantía. Cuando se ponga en contacto con nuestro Servicio Postventa, deberá indicar los códigos que figuran en la placa de características de su producto.

