

# Evelyn

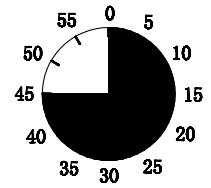

1

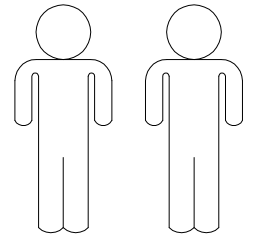
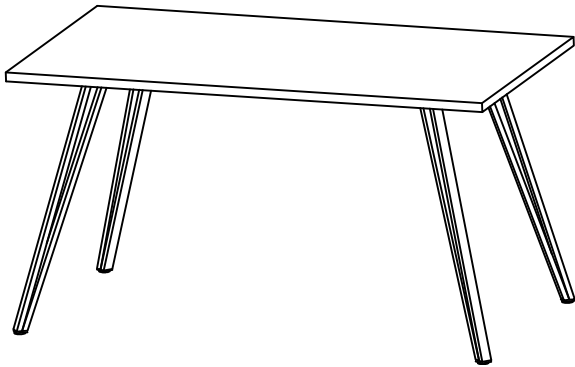
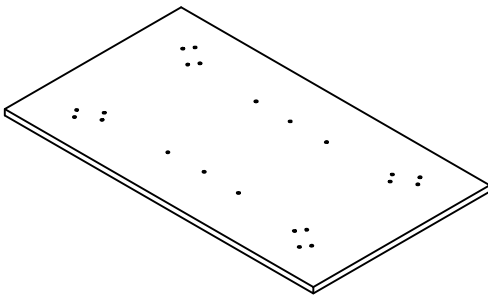

2

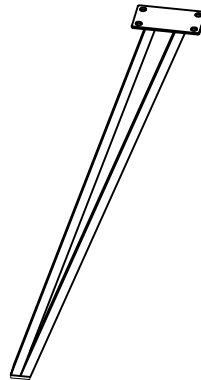

3

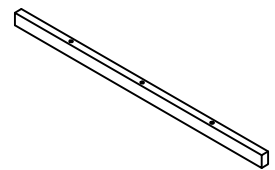

		
1	1x	1/2
2	4x	2/2
3	2x	2/2

A

M6\*18



6X

B

M8\*18



16X

C

M6\*40



6X

D

M8\*20



16X

E

Ø18\*Ø8\*1.5



16X

F

Ø25



4X

G

Ø18\*Ø6\*1.5



2X

H

5mm



1X

I

6mm

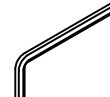

1X

J

8mm

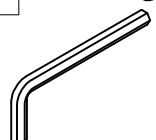

1X

1.

1.

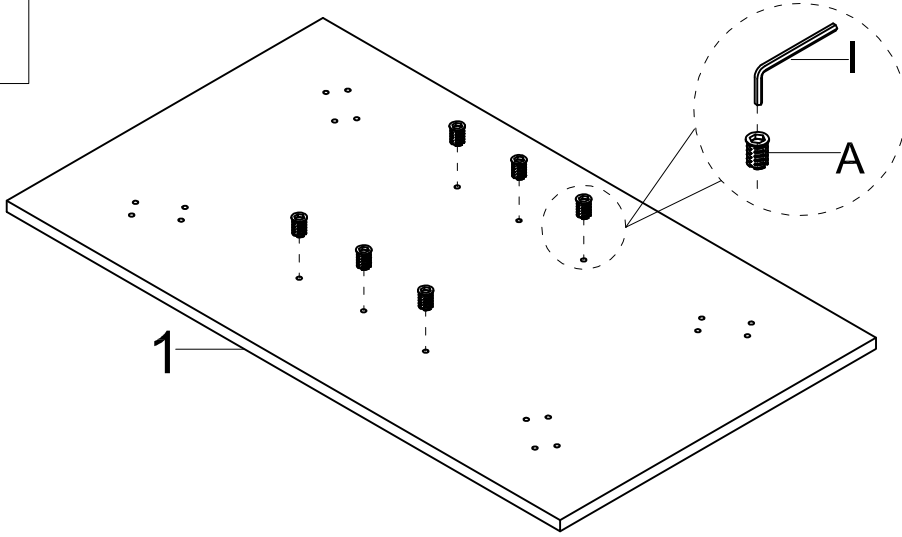

A

M6\*18  
6X

I

6mm  
1X



2.

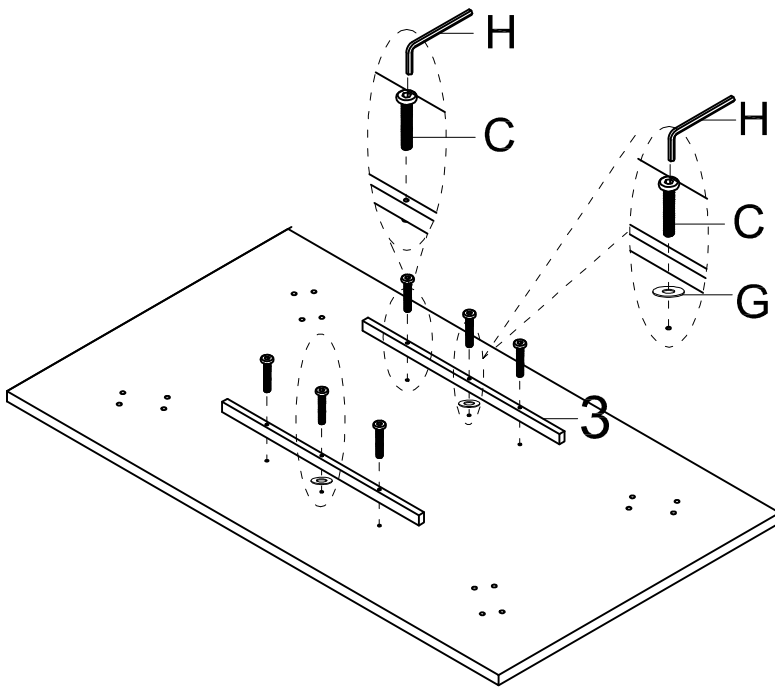

C

M6\*40  
6X

G

Ø18\*Ø6\*1.5  
2X

H

5mm  
1X



3.

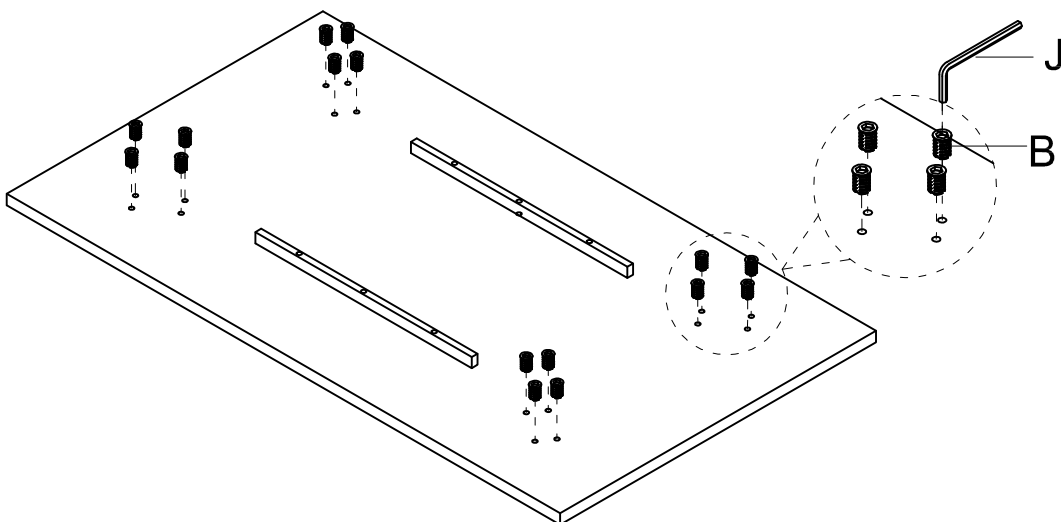

B

M8\*18  
16X

J





8mm  
1X

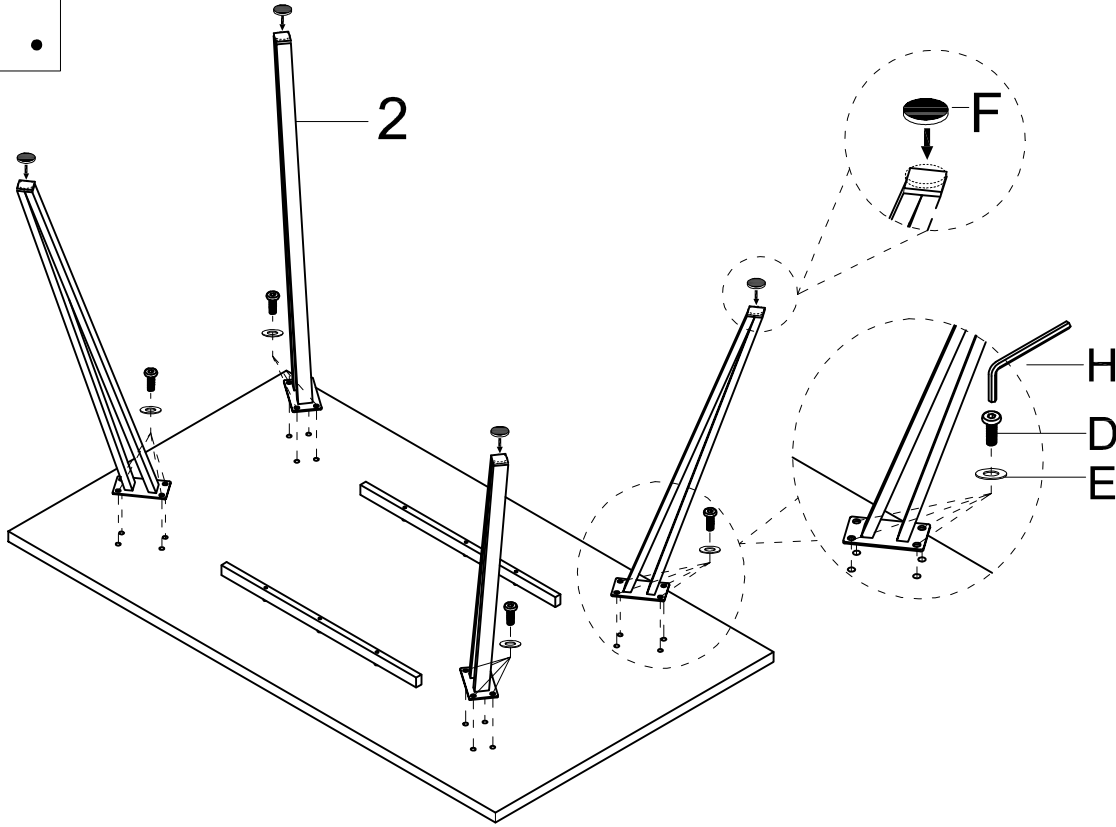

II.

4.



D	M8*20  16X
E	Ø18*Ø8*1.5  16X
F	Ø25  4X
H	5mm  1X
	

5.

