

- (D) Montageanleitung
- (NL) Handleiding voor de montage
- (HU) Szerelési útmutató
- (GB) Assembly instructions
- (PL) Instrukcja montażu
- (RO) Instrucțiuni de montaj

- (FR) Notice de montage
- (CZ) Montážní návod
- (TR) Montaj talimatı
- (IT) Istruzioni di montaggio
- (SK) Návod na montáž
- (RU) Инструкция по монтажу

**Service • Assistenza • Dienstverlening • Serwis
Servis • Szerviz • Сервисная служба**

Name • Nom • Nome • Naam •
Nazwa • Jméno • Názov • Név •
Denumire • Ísim • Название

Nr. • No. • N° • Номер • Č • Sz

Тур • Туре • Tip • Típus • Тиро •
Тип

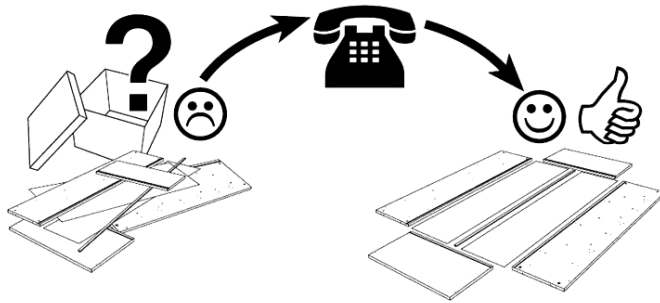
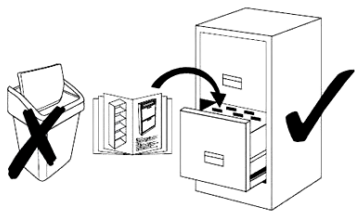

1	1x	ca. 759 x 330 mm
2	1x	ca. 1755 x 740 mm
3	1x	ca. 728 x 330 mm

4	1x	ca. 1835 x 330 mm
5	1x	ca. 1742 x 315 mm
6	1x	ca. 1835 x 330 mm
7	1x	ca. 517 x 310 mm
8	1x	ca. 728 x 77 mm
9	4x	ca. 196 x 310 mm
10	1x	ca. 1775 x 545 mm
11	3x	ca. 517 x 310 mm

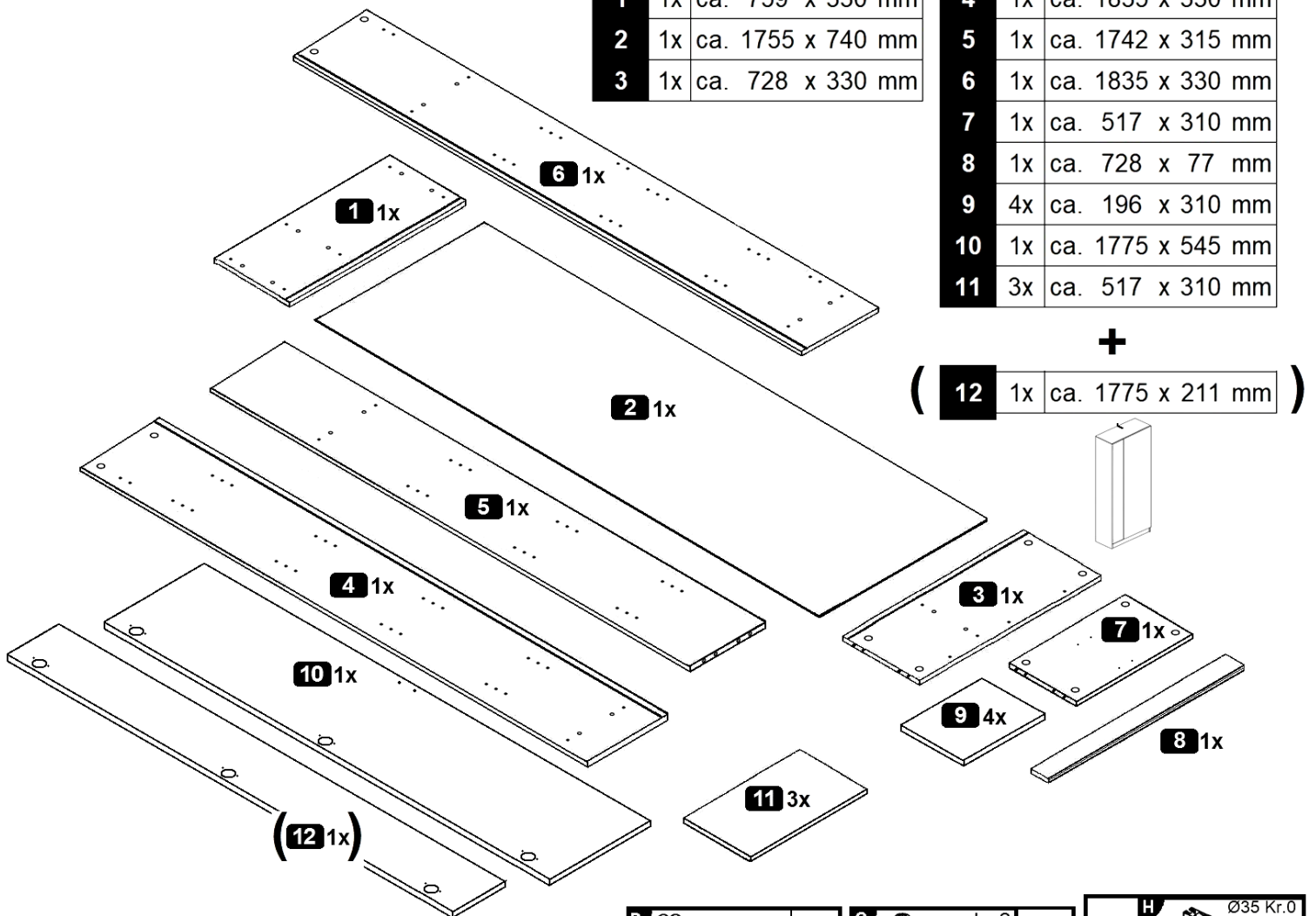

A 8,0 x 30 mm 16x	B 3,0 x 40 mm 16x	C 2,7 x 20 mm 16x
F 1x	I 3x	J 4x
E 28x		

D 3,9x9,5mm 1x	G h=2 3x	H Ø35 Kr.0 3,5x13 mm 3x
D 3,9x9,5mm 1x	G h=2 3x	H Ø35 Kr.0 3,5x13 mm 3x



1

A 8,0 x 30 mm **16x**

B **16x**

C **16x**

G h=2 **3x**

D 3,9x9,5mm **1x**

D 3,9x9,5mm **1x**

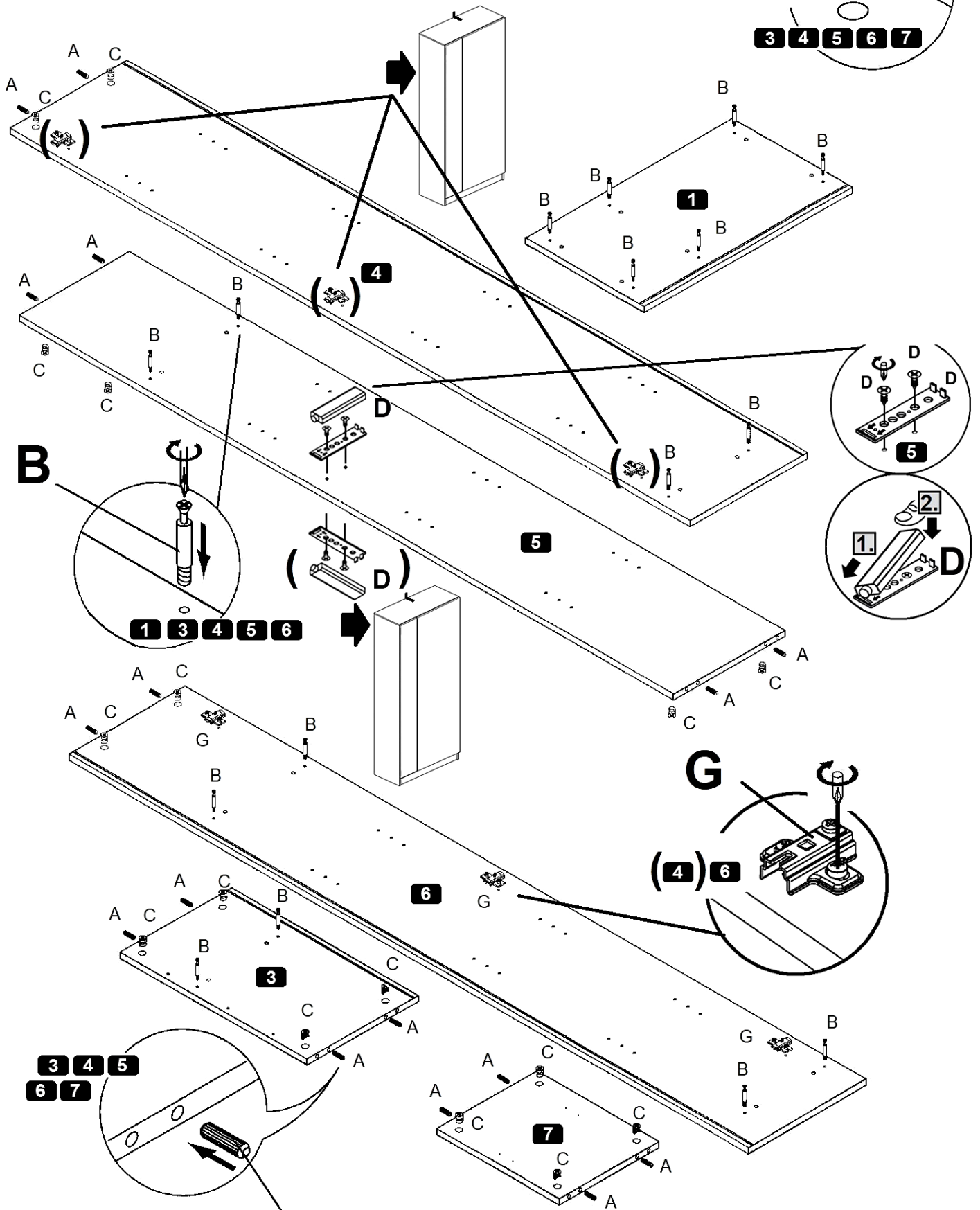

2

- I** 3,0 x 40 mm
3x
- J** 2,7 x 20 mm
4x
- E**
28x

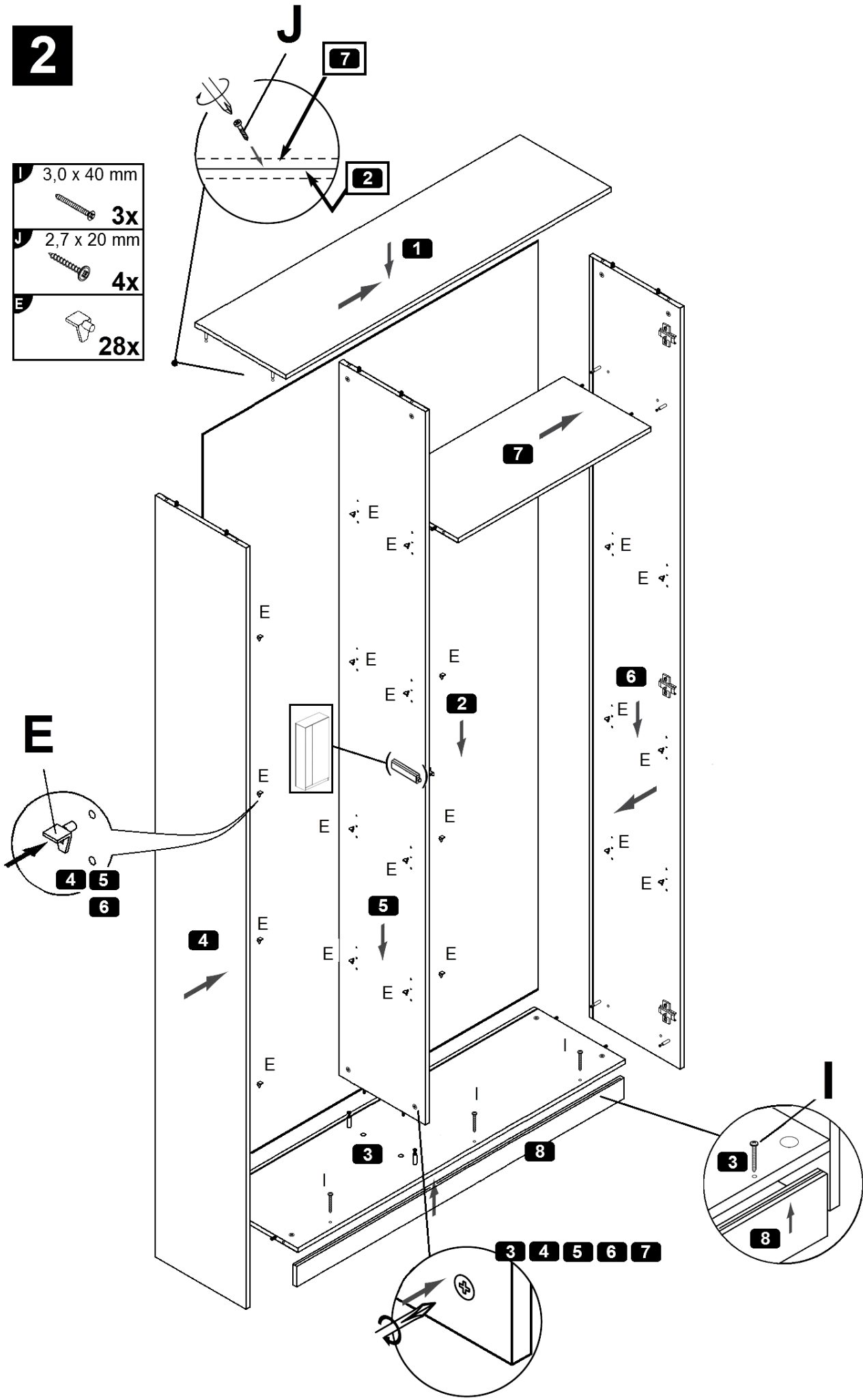

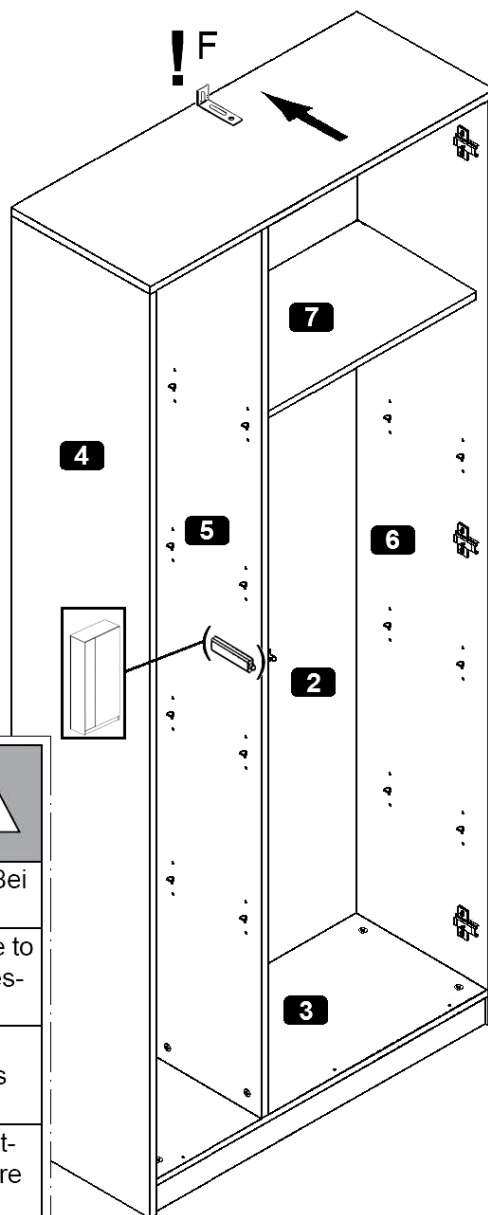
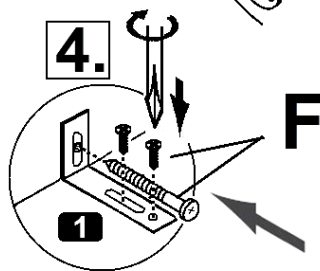
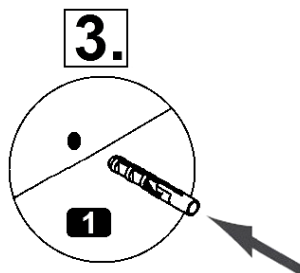
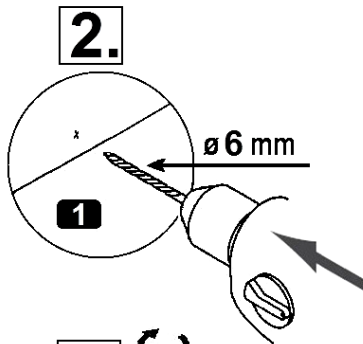
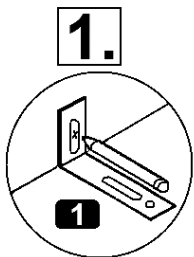

Achtung • Attention • Attenzione Opgelet • Uwaga • Pozor • Figyelem Atenție • Dikkat • Внимание	
(D)	Wandbefestigung dient als Kippschutz – unbedingt anbringen! Bei einigen Wandtypen kann ein Spezialdübel erforderlich sein!
(GB)	The wall fastening serves to prevent tipping – be absolutely sure to mount it! For certain wall types, a special wall plug may be necessary!
(FR)	La fixation murale sert de protection contre le basculement – à installer impérativement ! Pour certains types de murs il faut des chevilles spéciales !
(IT)	Il fissaggio alla parete serve da protezione anti-ribaltamento – attaccarla assolutamente! Per alcune strutture di parete può essere necessario un tassello speciale!
(NL)	Bevestiging aan de muur dient als kantelbescherming – zeker en vast bevestigen! Bij enkele muurtypes is een speciale plug mis-schien vereist!
(PL)	Mocowanie do ściany jest jednocześnie zabezpieczeniem przed przewróceniem – koniecznie zamontować! Do niektórych rodzajów ścian koniecznie zastosować specjalne kołki mocujące.
(CZ)	Montáž na stěnu slouží jako ochrana proti převrnutí – bezpodmínečně umístěte! U některých typů stěn může být zapotřebí speciální hmoždinka!
(SK)	Upevnenie na stenu slúži ako ochrana proti prevráteniu – bezpodmínečne použite! Pre niektoré druhy stien môže byť potrebná špeciálna hmoždinka!
(HU)	A terméket a falhoz kel rögzíténi, különben az felborulhat! Egyes faltípusoknál speciális tiplit kell használni!
(RO)	Sistemul de fixare la perete servește ca protecție la răsturnare – de montat obligatoriu! Pentru unele tipuri de pereți este posibil să fie necesar un diblu special!
(TR)	Duvardaki sabitleme, devrilmeye karşı bir emniyet tedbiridir ve mutlaka monte edilmelidir! Bazı duvar tiplerinde bunun için özel bir dübel gerekli olabilir!
(RU)	Обязательно установите крепление на стене во избежание опрокидывания! Для некоторых типов стен может потребоваться специальный дюбель!

➔ 7 / 8

- (D)** Push-To-Open einstellen
- (GB)** Adjusting the Push-To-Open
- (FR)** Régler les Push-To-Open
- (IT)** Sistemare Push-To-Open
- (NL)** Push-To-Open instellen
- (PL)** Nastawić Push-To-Open
- (CZ)** Vyrovnejte Push-To-Open
- (RO)** Nastavenie Push-To-Open
- (HU)** Állítsa be az Push-To-Open
- (SK)** Reglare Push-To-Open
- (TR)** Push-To-Open ayarlanması
- (RU)** Регулировка Push-To-Open

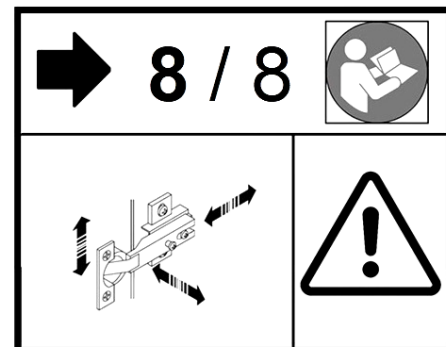
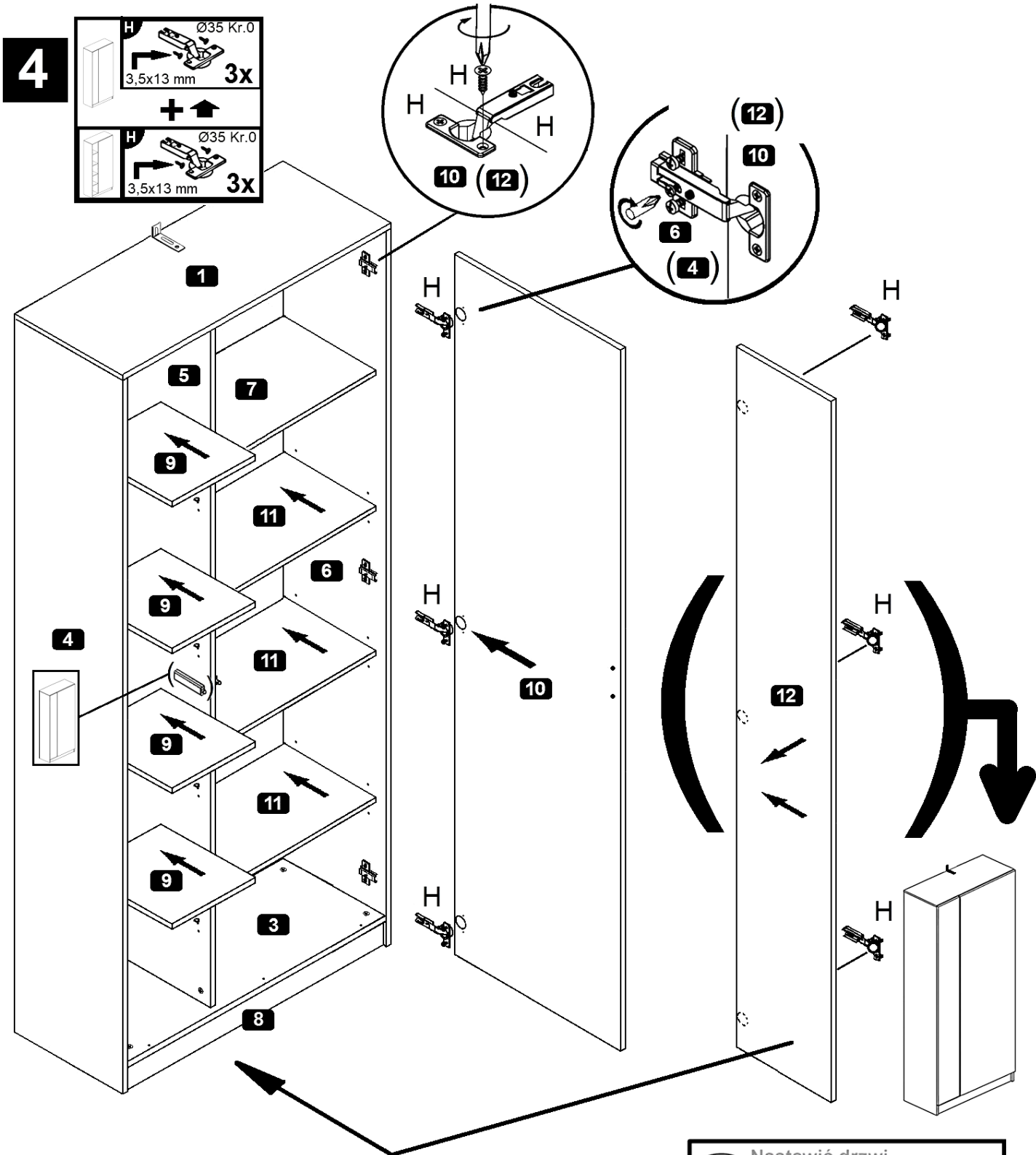

- (D) Türen einstellen (Scharniere justieren)
- (GB) Adjusting the doors (adjusting the hinges)
- (FR) Régler les portes (ajuster les charnières)
- (IT) Sistemare le porte (regolare le cerniere)
- (NL) Deuren instellen (scharnieren afstellen)

- (PL) Nastawić drzwi (wyregulować zawiasy)
- (CZ) Vyrovnajte dvířka (seříd'te závěsy)
- (RO) Nastavenie dveri (nastavenie závesov)
- (HU) Állítsa be az ajtókat (állítsa be a zsanérokat)
- (SK) Reglare uši (ajustare balamale)
- (TR) Kapıların ayarlanması (menteselerin seviye ayarı)
- (RU) Регулировка дверей (регулировка шарнира)

5

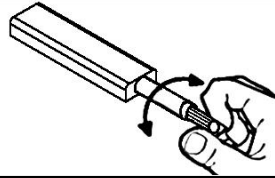

(D) **Push-To-Open einstellen**

(CZ) **Vyrovnejte Push-To-Open**

(GB) **Adjusting the Push-To-Open**

(RO) **Nastavenie Push-To-Open**

(FR) **Régler les Push-To-Open**

(HU) **Állítsa be az Push-To-Open**

(IT) **Sistemare Push-To-Open**

(SK) **Reglare Push-To-Open**

(NL) **Push-To-Open instellen**

(TR) **Push-To-Open ayarlanması**

(PL) **Nastawić Push-To-Open**

(RU) **Регулировка Push-To-Open**

1.

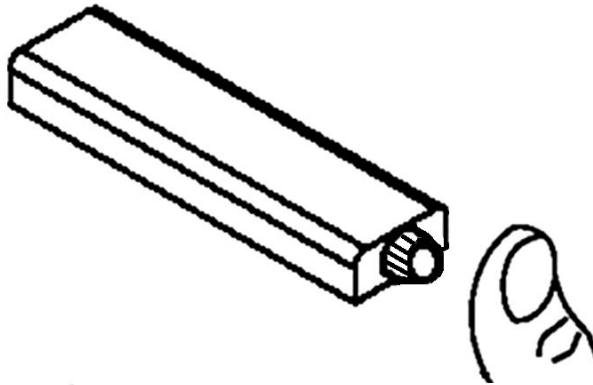

2.

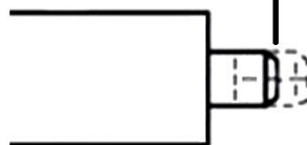
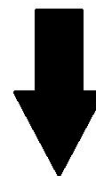
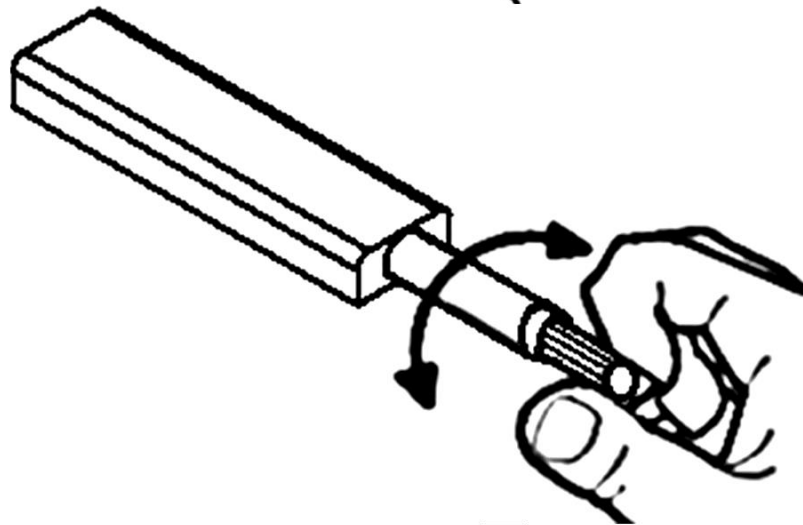

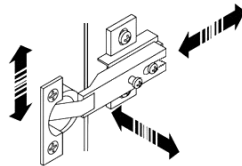
6

D Türen einstellen
(Scharniere justieren)

GB Adjusting the doors
(adjusting the hinges)

FR Régler les portes
(ajuster les charnières)

IT Sistemare le porte
(regolare le cerniere)

NL Deuren instellen
(scharnieren afstellen)

PL Nastawić drzwi
(wyregulować zawiasy)

CZ Vyrovnajte dvířka
(seřid'te závěsy)

RO Nastavenie dverí
(nastavenie závesov)

HU Állítsa be az ajtókat
(állítsa be a zsanérokat)

SK Reglare uši
(ajustare balamale)

TR Kapıların ayarlanması
(menteşelerin seviye ayarı)

RU Регулировка дверей
(регулировка шарнира)

