

Denise

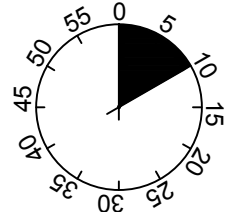

1

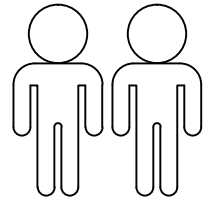
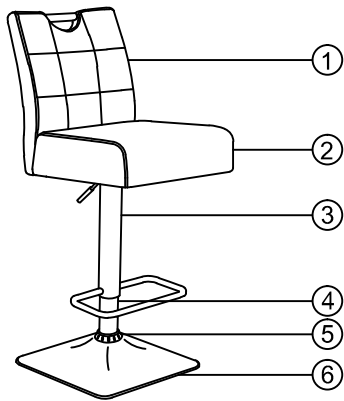
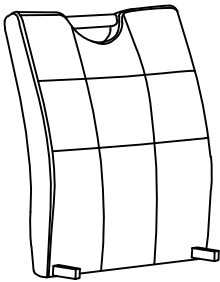

2

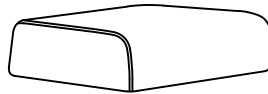

3

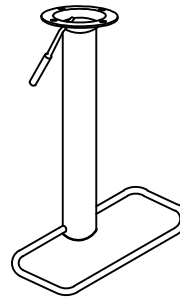

4



5



6

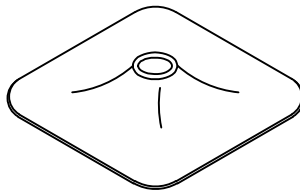

1	1X
2	1X
3	1X
4	1X
5	1X
6	1X

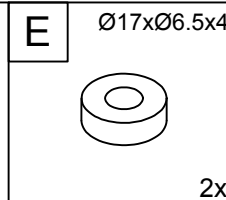
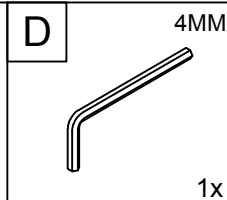
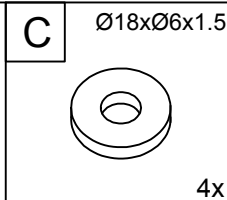
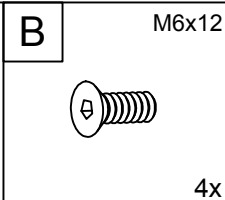
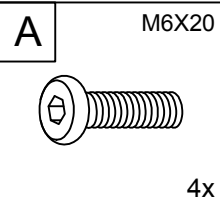

I.

1

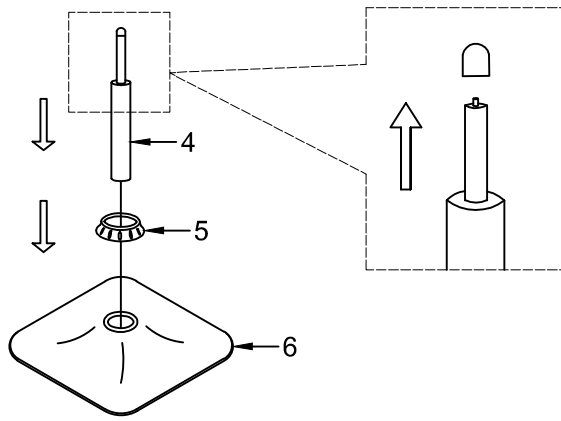

2

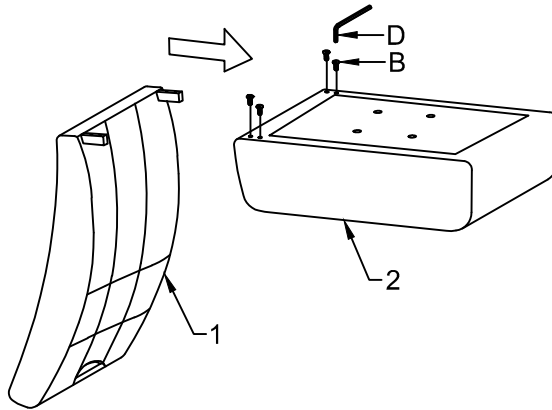

- B** M6x12
4x
 - D** 4MM
1x
-

3

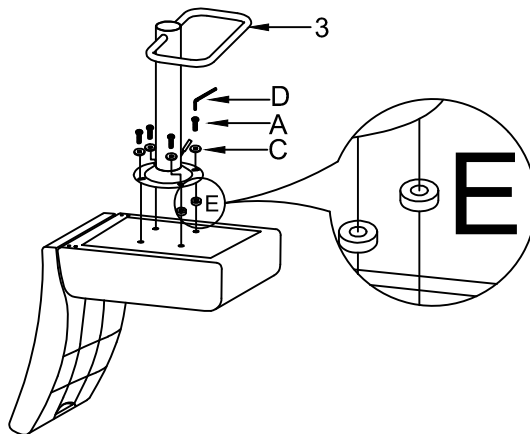

- A** M6x20
4x
 - C** Ø18xØ6x1.5
4x
 - D** 4MM
1x
 - E** Ø17xØ6.5x4
2x
-

4

