

Montageanleitung von sessel

OSCAR / Laurel

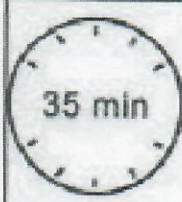





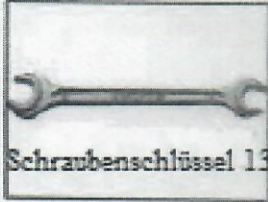



35 min



Schraubenschlüssel 13



Elemente in einem Satz

| | | | | | | |
|---|---|---|---|--|---|---|
| <p>A</p>  <p>L=135 x 2</p> | <p>B</p>  <p>L=120 x 2</p> | <p>C</p>  <p>x 4</p> | <p>D</p>  <p>x 4</p> | <p>E</p>  <p>MBX60 x 4</p> | <p>F</p>  <p>MBX70 x 2</p> | <p>K</p>  <p>MBx 6</p> |
|---|---|---|---|--|---|---|

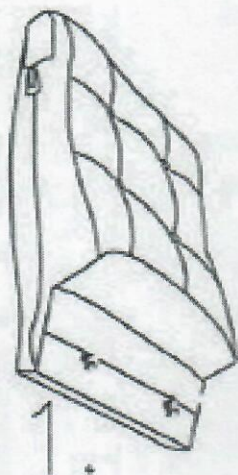

1.

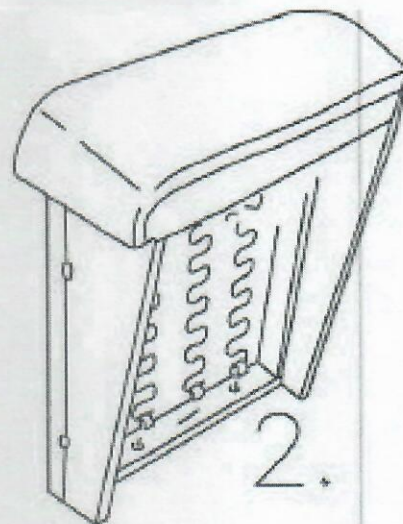

2.

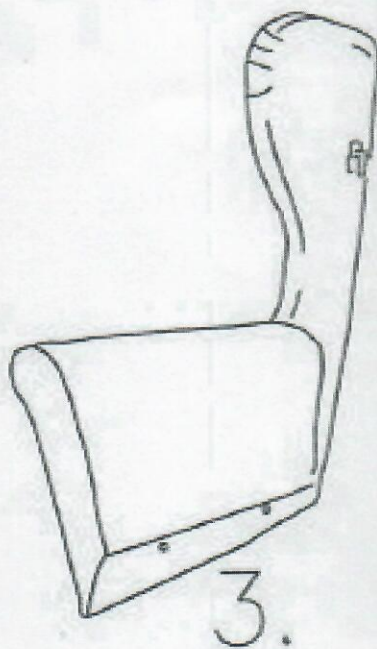

3.

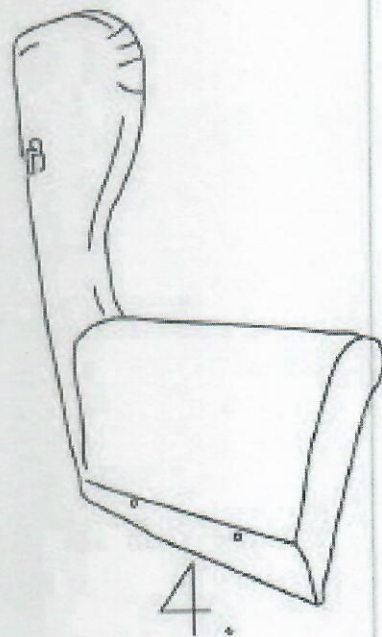

4.

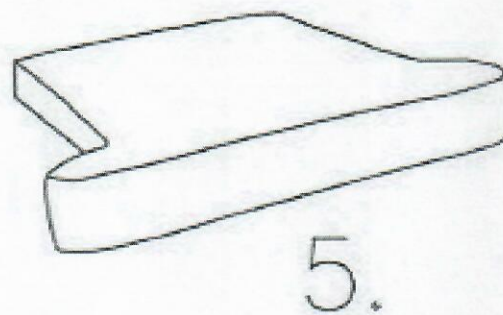

5.

1.

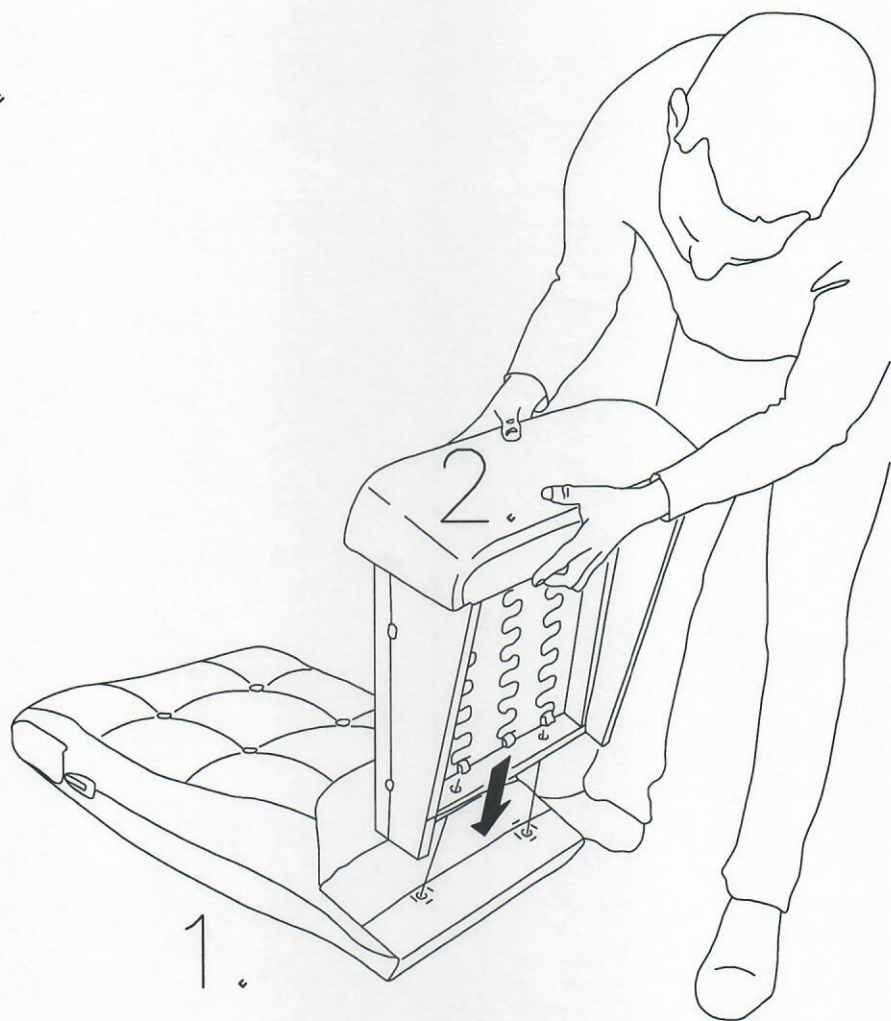

2.

1.

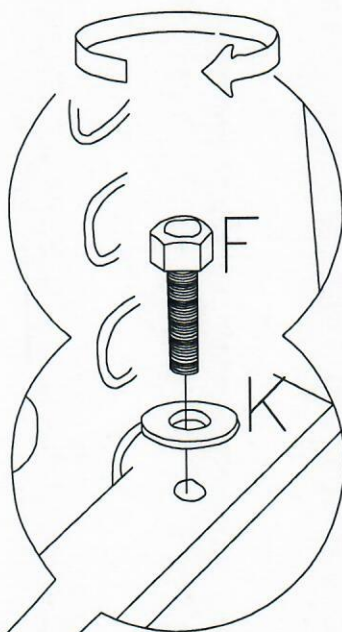
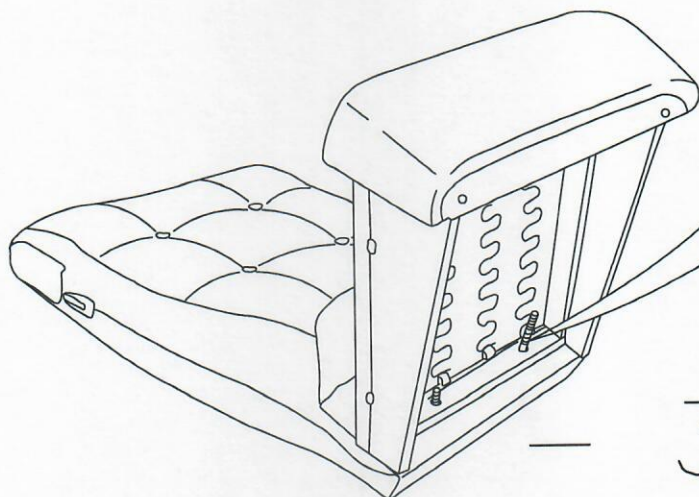

— 3 —

F



M8X70
x 2

K

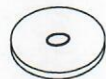

M8x 2

3.

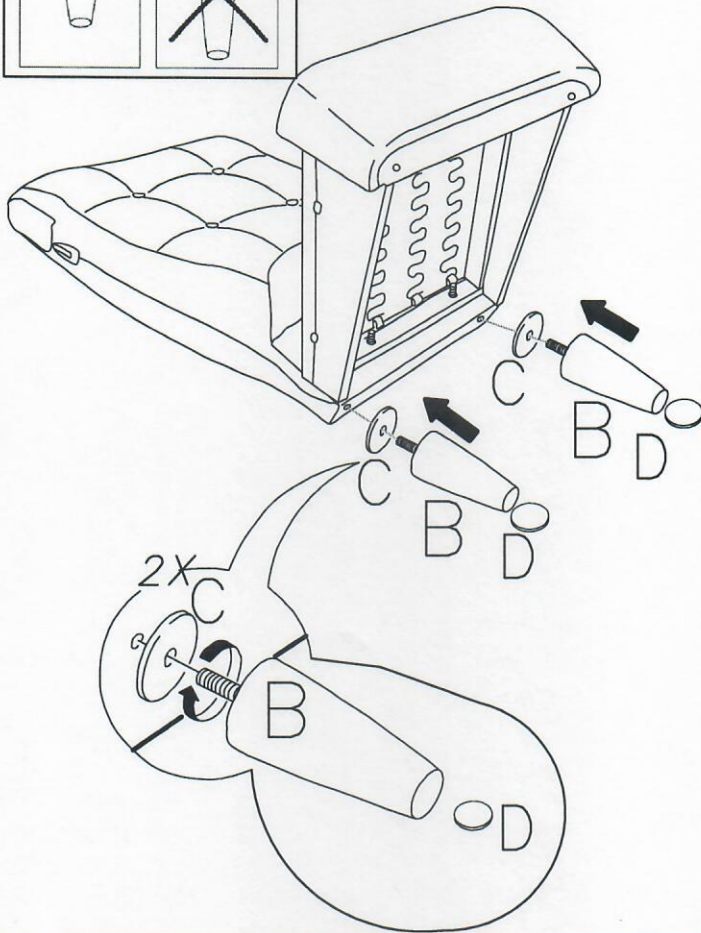
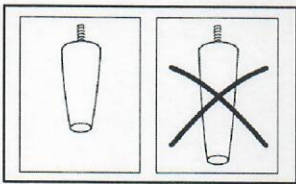

| | | |
|--------------|-----|-----|
| B | C | D |
| | | |
| L=120 x 2 | x 2 | x 2 |

4.

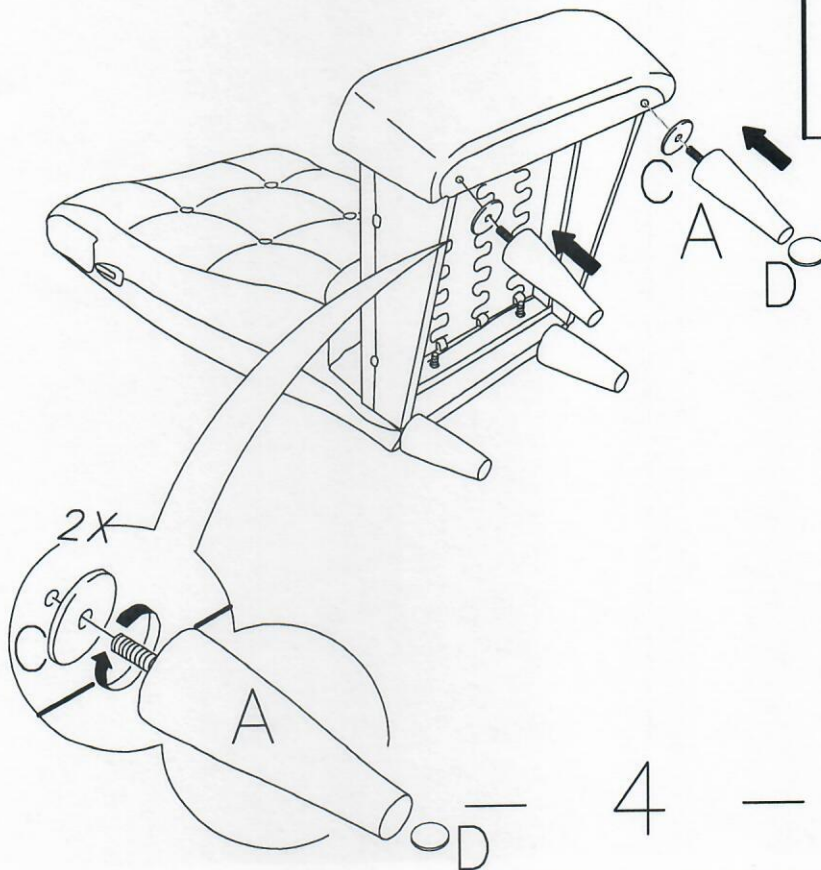

| | | |
|--------------|-----|-----|
| A | C | D |
| | | |
| L=135 x 2 | x 2 | x 2 |

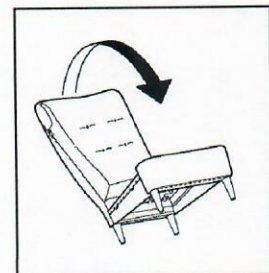

4

5.

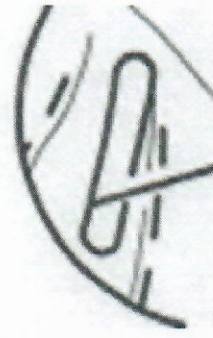
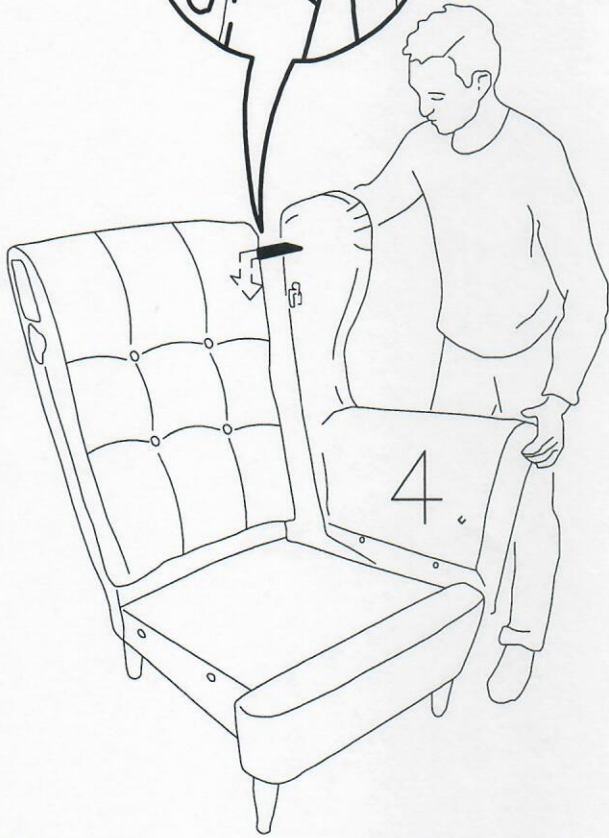

Nr 1
Einhängebeschlag
(Rückenlehne)



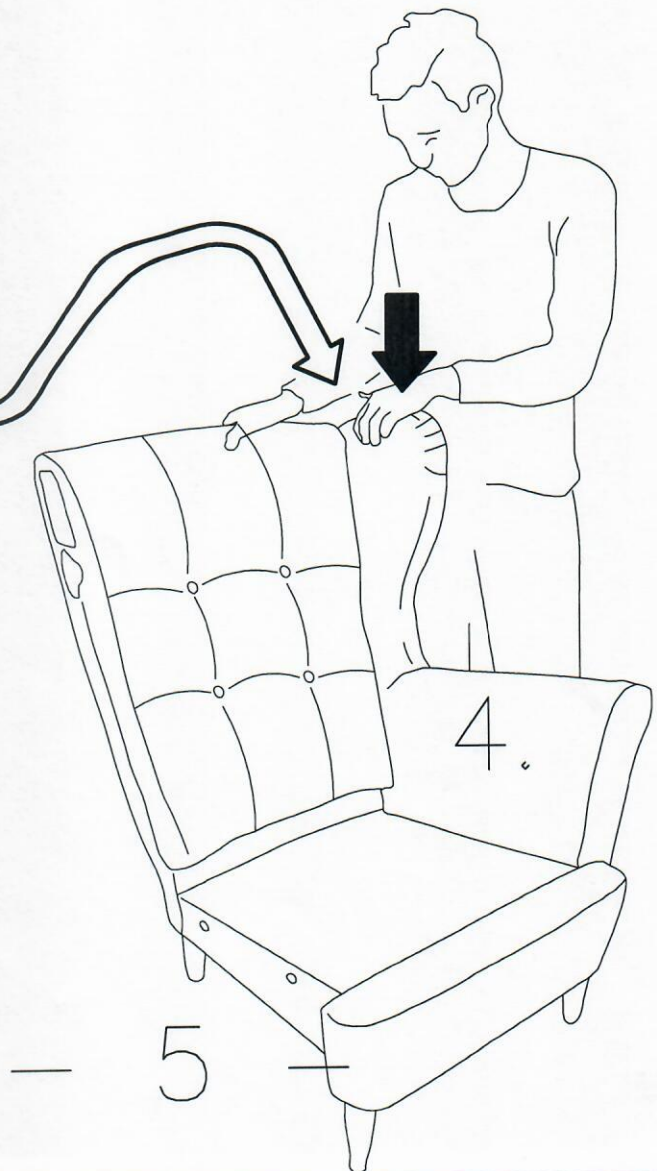
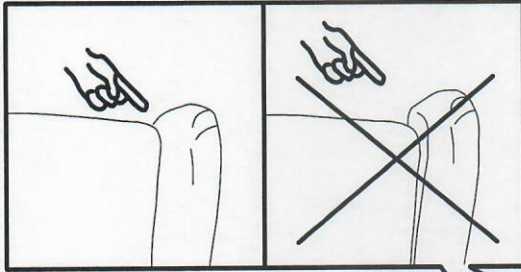

Nr 2
Aufhänger
(Gegenstück für
Einhängebeschlag)

6.



7.

| | |
|---|---|
| F | K |
|  |  |
| M8X60 x 2 | M8x 2 |

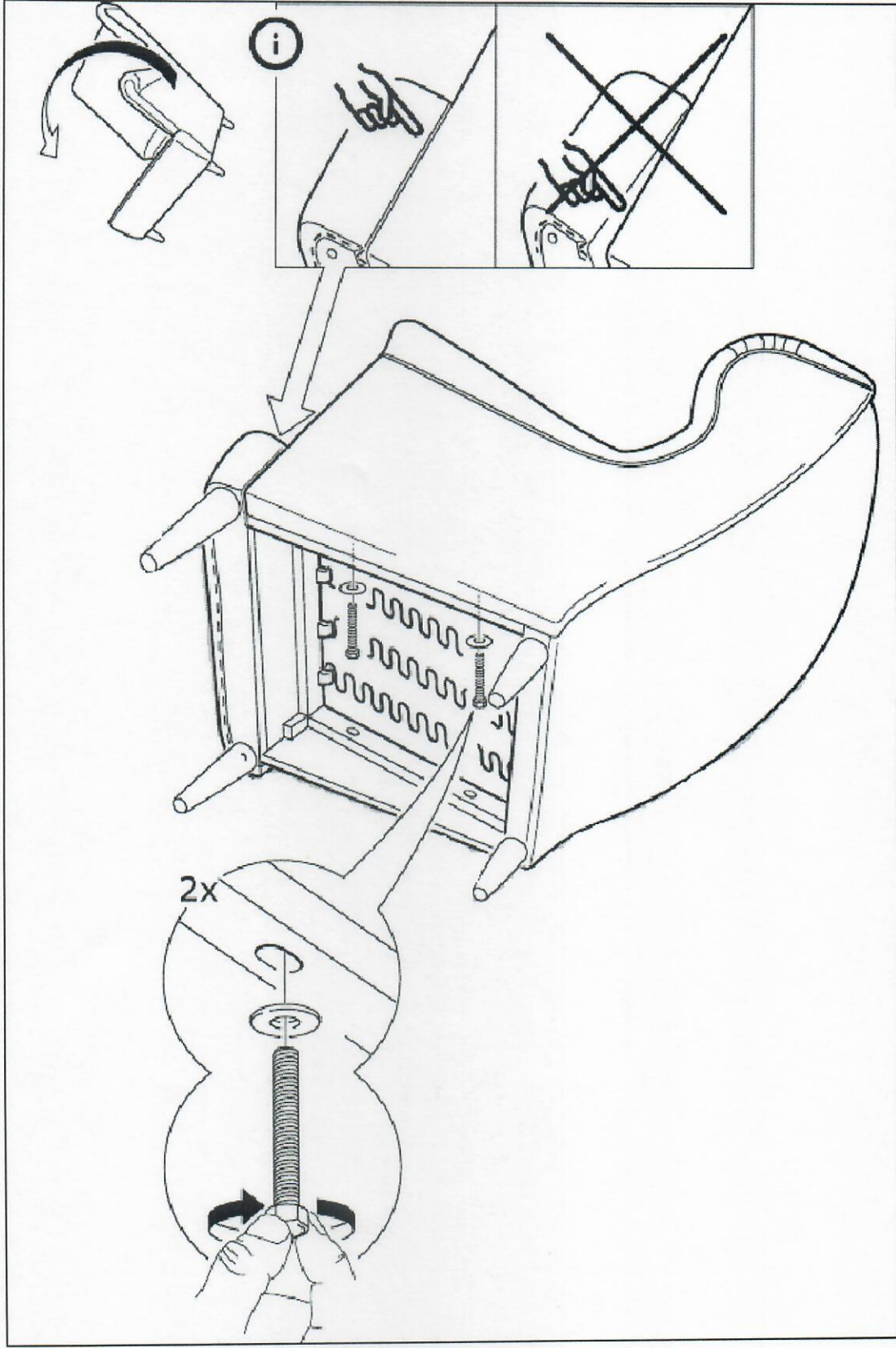

8.

F



M8X60
x 2

K



M8x 2

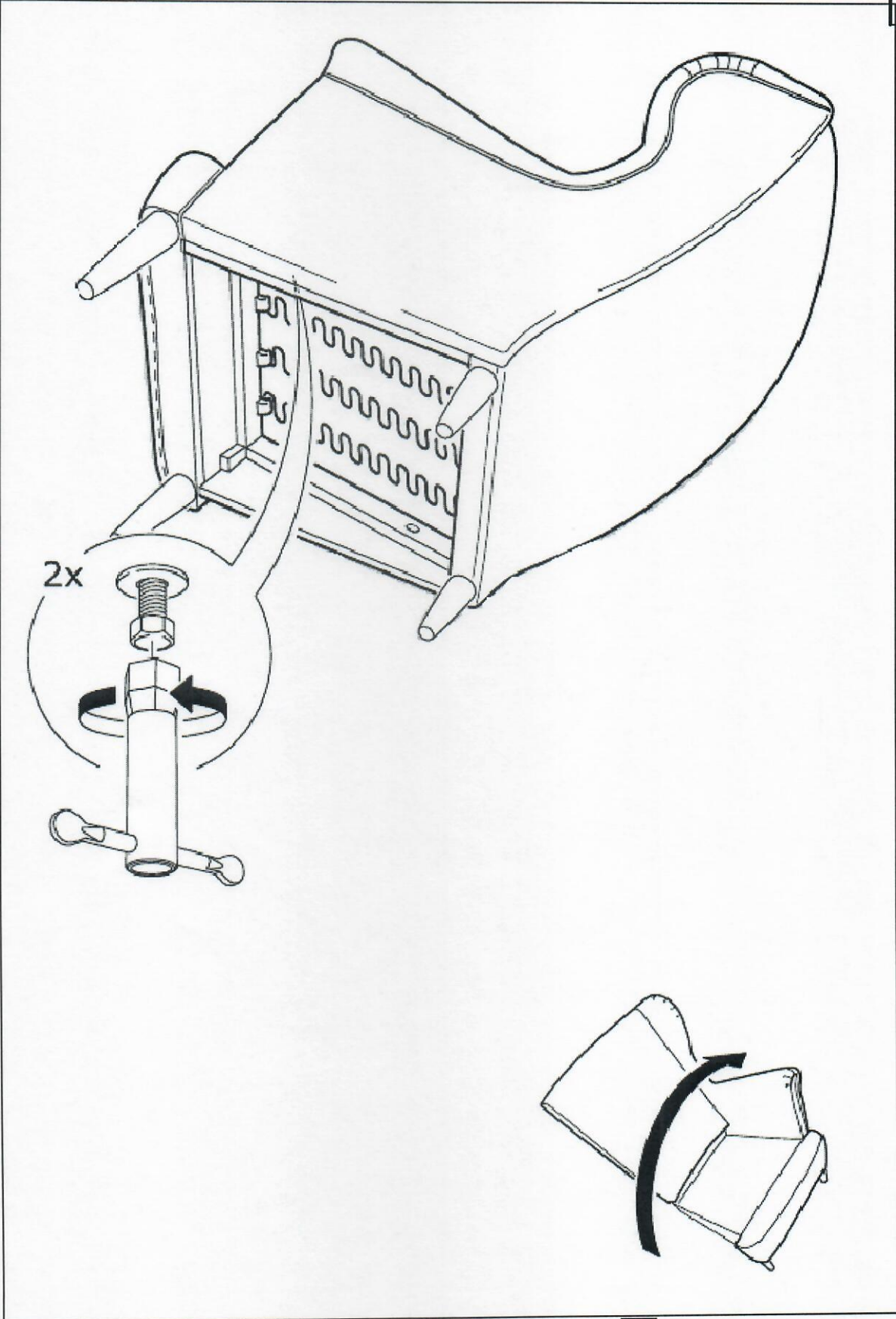

9. Die zweite Seitenwand ist Analog zu den Punkten 6-9 zu montieren.

10.



