

RUMBA 90

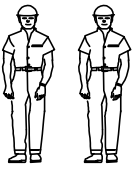

15min



- | | |
|----------------------------------|------------------------------|
| (D) Montageanleitung | (HU) Szerelési útmutató |
| (NL) Handleiding voor de montage | (PL) Instrukcja montażu |
| (TR) Montaj talimatı | (RU) Инструкция по монтажу |
| (F) Notice de montage | (IT) Istruzioni di montaggio |
| (CZ) Montážní návod | (SK) Návod na montáž |
| (GB) Assembly instructions | (RO) Instrucțiuni de montaj |

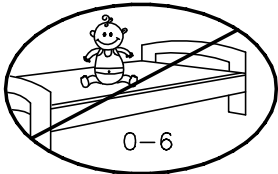
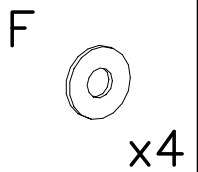
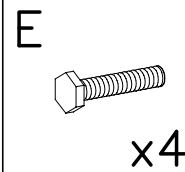
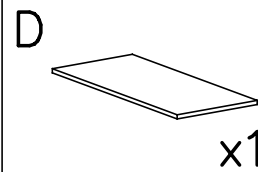
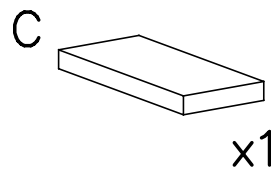
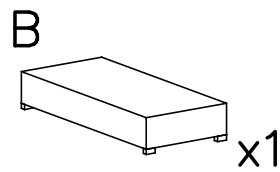
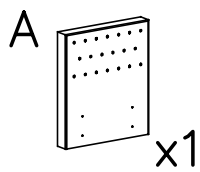
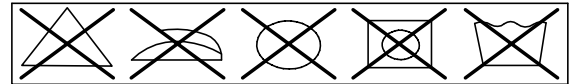
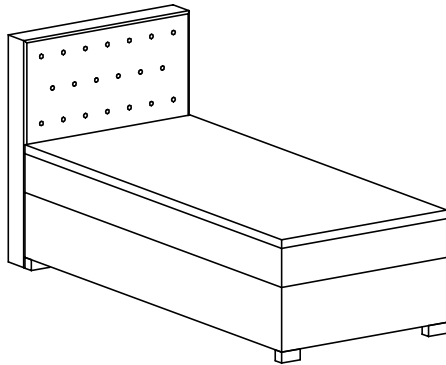

0-6

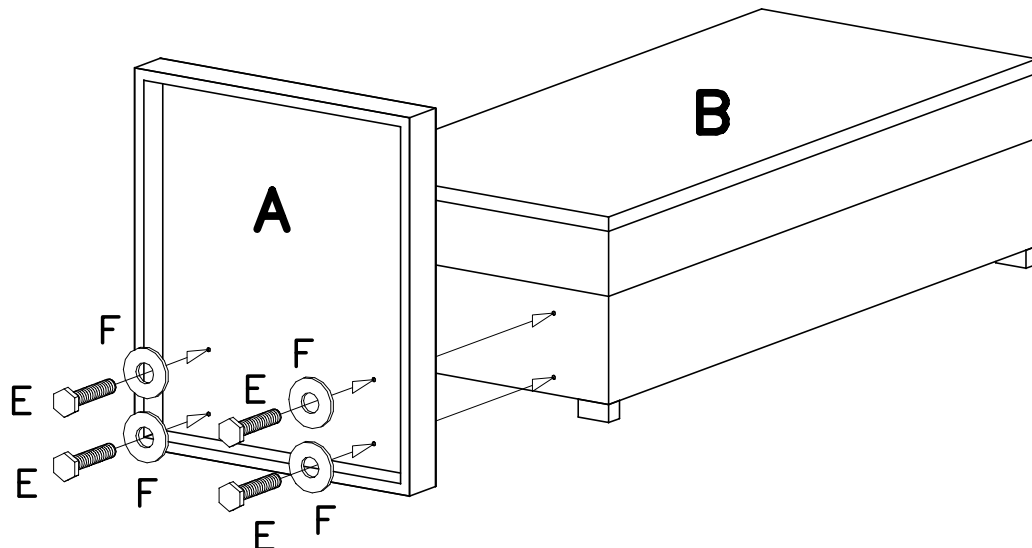
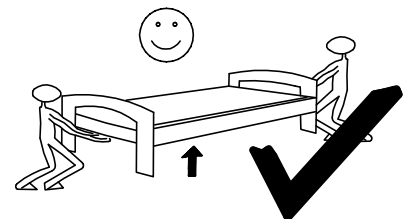
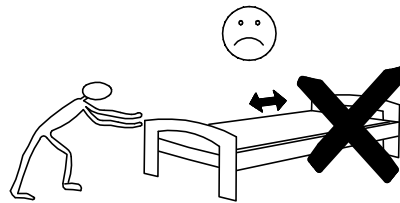
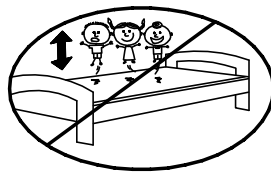

Service • Assistenza • Dienstverlening • Serwis •
 Servis • Szerviz • Сервисная служба

Name • Nom • Nome • Naam • Nazwa • Jméno • Názov • Név • Denimire • Isim • Название	RUMBA
Nr • No. • N° • Номер • Č • Sz	
Type • Tipo • Típus • Тип • Тип • Тір	90

