

Cremona

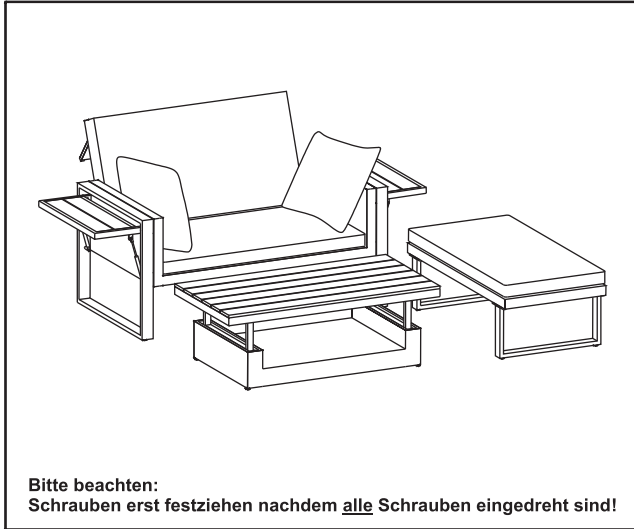

- | | |
|-------------------------------|---------------------------|
| Ⓓ Montageanleitung | Ⓖ Assembly instructions |
| Ⓕ Notice de montage | Ⓘ Istruzioni di montaggio |
| Ⓖ Handleiding voor de montage | Ⓟ Instrukcja montażu |
| Ⓒ Montážní návod | Ⓢ Návod na montáž |
| Ⓗ Szerelési utmutató | Ⓡ Instrucțiuni de montaj |
| Ⓣ Montaj talimatı | Ⓡ Инструкция по монтажу |

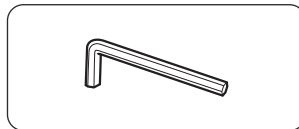
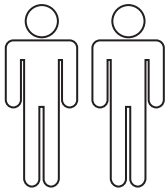

**D: WICHTIG, FÜR SPÄTERE BEZUGNAHME
DIESES DOKUMENT AUFBEWAHREN!
SORGFÄLTIG LESEN!**

Dieses Außenmöbel ist nur zur Verwendung im privaten Wohnbereich vorgesehen.

**GB: IMPORTANT, HOLD ON TO THIS DOCUMENT
FOR LATER REFERENCE! READ CAREFULLY!**

This outdoor furniture is only intended for use in private residential areas.

**FR: IMPORTANT, CONSERVER CE DOCUMENT
POUR VOUS Y RÉFÉRER ULTÉRIEUREMENT! LE
LIRE ATTENTIVEMENT!**

Ce meuble d'extérieur n'est prévu que pour une utilisation dans le domaine privé.

**IT: IMPORTANTE, CONSERVARE LE PRESENTI
ISTRUZIONI PER OGNI ULTERIORE
CONSULTAZIONE! LEGGERE CON ATTENZIONE!**

Il presente mobile da esterno è previsto solo per l'uso in ambito domestico.

**NL: BELANGRIJK, BEWAAR DIT DOCUMENT ALS
REFERENTIE IN DE TOEKOMST!**

ZORGVULDIG LEZEN! Dit buitenmeubel is alleen bedoeld voor het gebruik in privéwoningen.

**PL: WAŻNE, DOKUMENT PRZECHOWAĆ NA
PRZYSZŁOŚĆ JAKO MATERIAŁ REFERENCYJNY!
DOKŁADNIE PRZECZYTAĆ!**

Ten mebel zewnętrzny jest przewidziany jedynie do użytku w prywatnych strefach mieszkalnych.

**RO: IMPORTANT! PĂSTRAȚI ACEST DOCUMENT
PENTRU CONSULTAREA ULTERIOARĂ! CITIȚI CU
ATENȚIE!**

Acest mobilier de exterior este destinat doar utilizării în zonele de locuit private.

**RU: ВАЖНО СОХРАНИТЬ ЭТОТ ДОКУМЕНТ ДЛЯ
ИСПОЛЬЗОВАНИЯ В ДАЛЬНЕЙШЕМ!
ВНИМАТЕЛЬНО ОЗНАКОМЬТЕСЬ С НИМ!**

Этот предмет уличной мебели предназначен только для использования в частных жилых зонах.

**SK: DÔLEŽITÉ, USCHOVAJTE SI TENTO
DOKUMENT PRE BUDÚCE POUŽITIE! ČÍTAJTE
POZORNE!**

Tento vonkajší nábytok je určený len na použitie v súkromnom obytnom priestore.

**CZ: DŮLEŽITÉ! TENTO DOKUMENT SI
USCHOVEJTE PRO POZDĚJŠÍ POUŽITÍ. ČTĚTE
POZORNĚ!**

Tento venkovní nábytek je určený pouze k použití v soukromém obytném prostoru.

**HU: FONTOS – KÉSŐBBI FELHASZNÁLÁSRA
ŐRIZZE MEG EZT A DOKUMENTUMOT!
GONDOSAN OLVASSA EL!**

Ez a kültéri bútor csak magán lakóterületen történő használatra szolgál.

**TR: ÖNEMLİ, DAHA SONRA FAYDALANMAK İÇİN
BU DOKÜMANI SAKLAYIN! DİKKATLİCE OKUYUN!**

Bu dış mekan mobilyası sadece özel oturma alanında kullanılması için tasarlanmıştır.

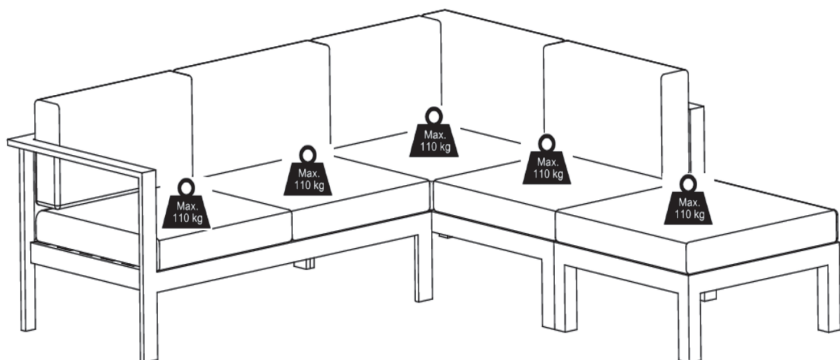

0
10
20
30
40
50
60
70
80
90
100
110
120
130
140
150
160
170
180
190
200

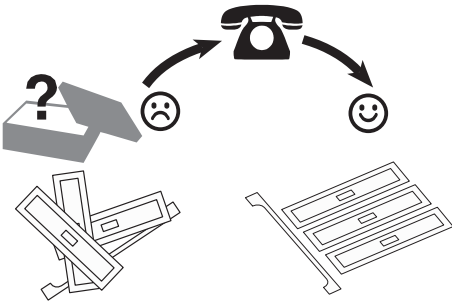
Service		
Name	Cremona	
No.	73904955	
EAN	56826717 4029686503663	
Type		

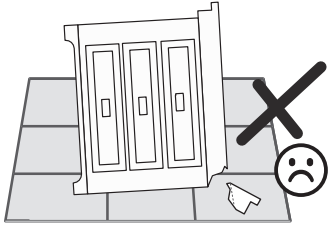
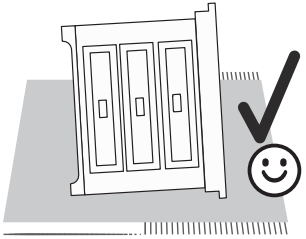

Imported by: **AproductZ GmbH**
Werner-Otto-Straße 1-7, 22179 Hamburg, Germany

Colli 1:

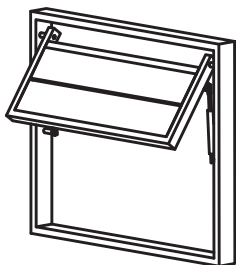

2x

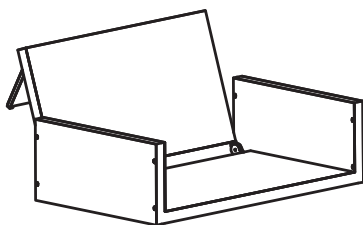

1x

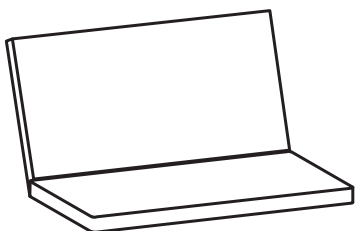

1x

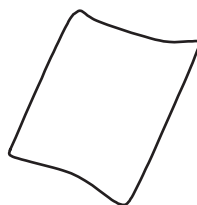

2x

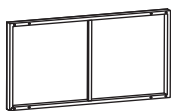

1x

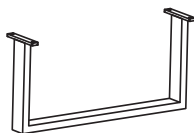

2x



1x

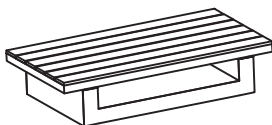

1x

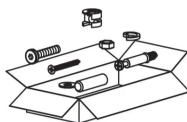

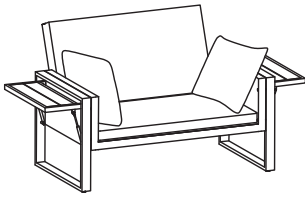

1

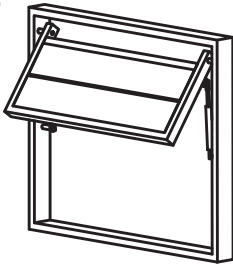

2x

2

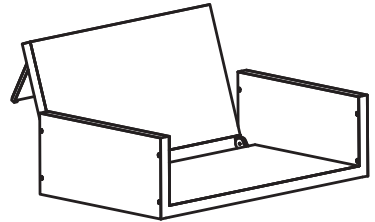

1x

3

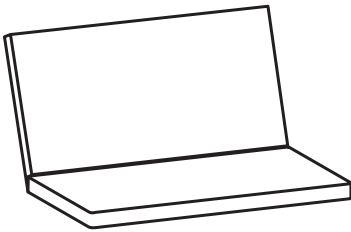

1x

4

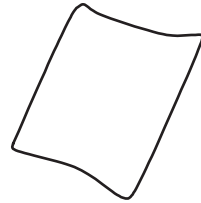

2x

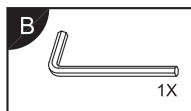
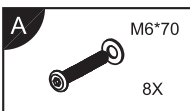

1

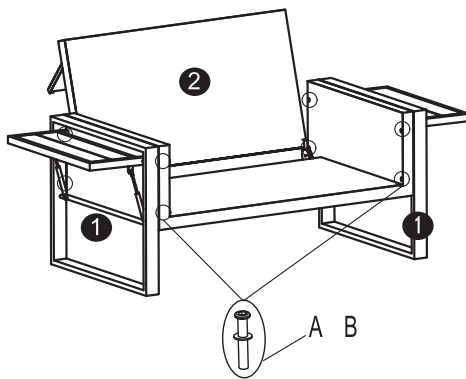

2

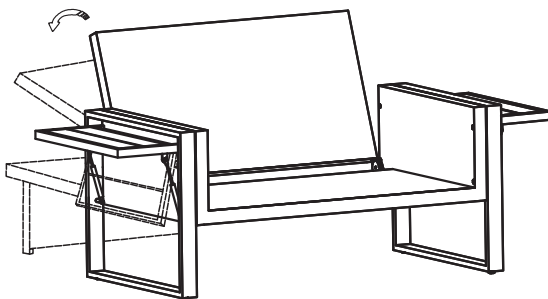

3

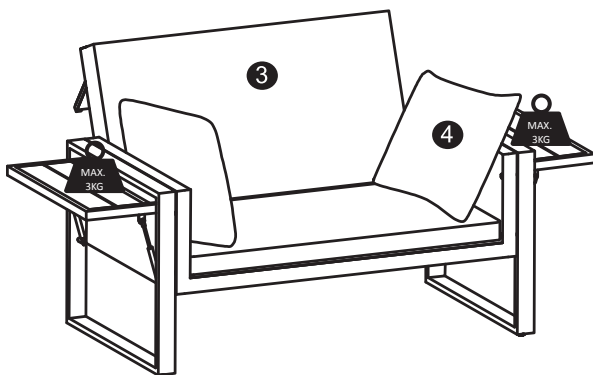

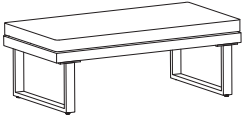

5

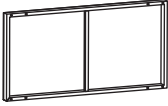

1x

6

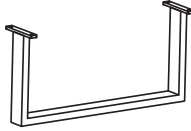

2x

7

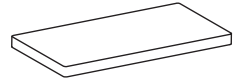

1x

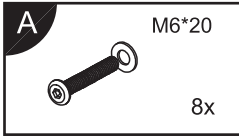

1

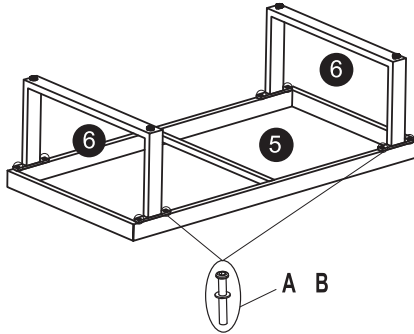

2

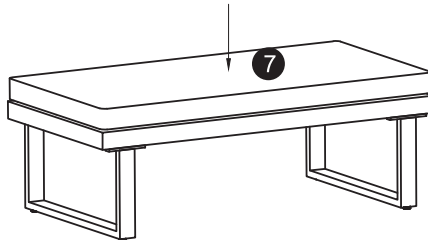

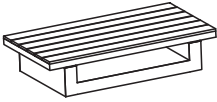

8

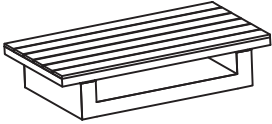

1x

A

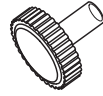

4x

1

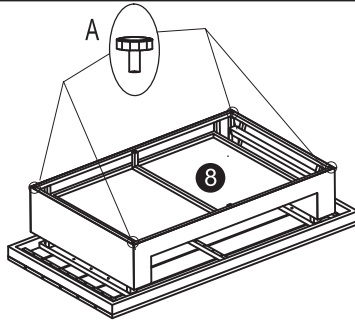

2

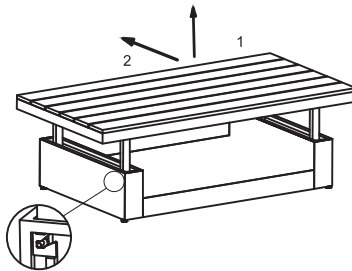

3

