

**D** MONTAGEANLEITUNG  
BEDIENUNGSANLEITUNG

**NL** HANDLEIDING VOOR DE MONTAGE  
GEBRUIKSAANWIJZING

**TR** MONTAJ TALIMATI  
KULLANIM KLAVUZU

**RO** INSTRUCȚIUNI DE INSTALARE  
INSTRUCȚIUNI DE UTILIZARE

**FR** NOTICE DE MONTAGE  
MANUEL INSTRUCTIONS

**HU** KÖZGYŰLÉS UTASÍTÁSOK  
KEZELÉSI UTASÍTÁS

**SI** NAVODILA ZA MONTAŽO  
NAVODILA ZA UPORABO

**ES** INSTRUCCIONES DE MONTAJE  
MANUAL DEL USUARIO

**GB** ASSEMBLY INSTRUCTIONS  
INSTRUCTION MANUAL

**PL** INSTRUKCJA MONTAŻU  
INSTRUKCJA OBSŁUGI

**RU** ИНСТРУКЦИЯ ПО МОНТАЖУ  
ИНСТРУКЦИЯ ПО ЭКСПЛУАТАЦИИ

**IT** ISTRUZIONI DI MONTAGGIO  
MANUALE DI ISTRUZIONI

**SK** MONTÁŽNY NÁVOD  
NÁVOD NA POUŽITIE

**CZ** MONTÁŽNÍ NÁVOD  
NÁVOD K POUŽITÍ

**PT** INSTRUÇÕES DE MONTAGEM  
MANUAL DO USUÁRIO

**HR** UPUTE ZA MONTAŽU  
UPUTE ZA UPOTREBU

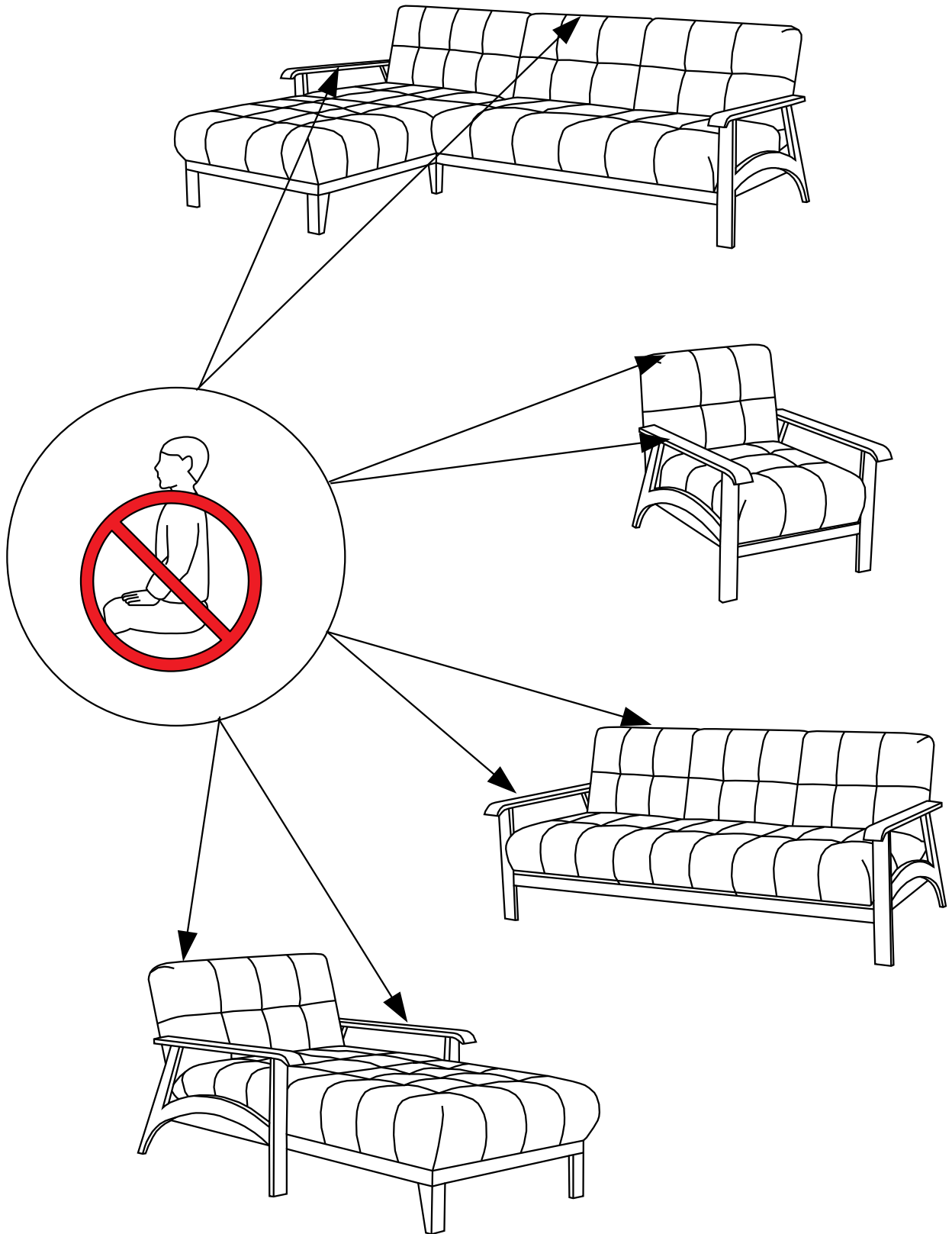

Name · Naam · Nazwa · Ísim · Название · Nume · Nome · Názov · Názov ·  
Název · Neve

**BILLUND**



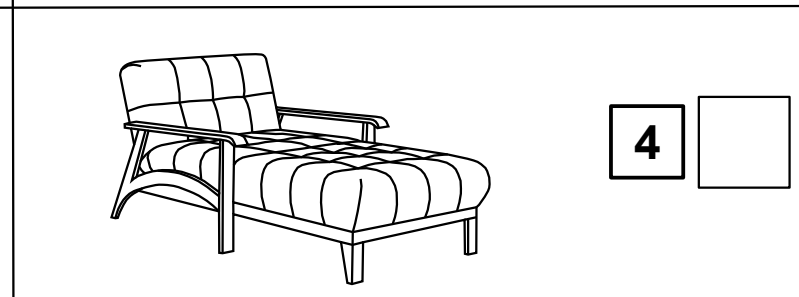
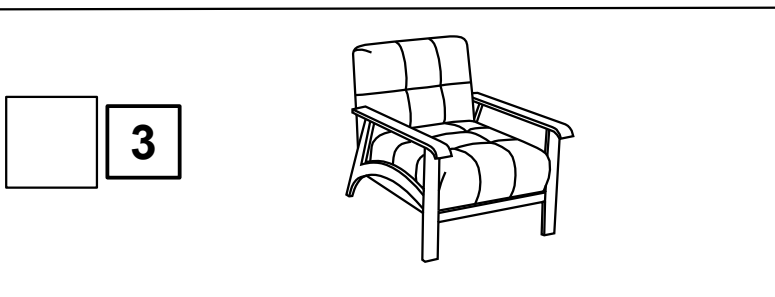
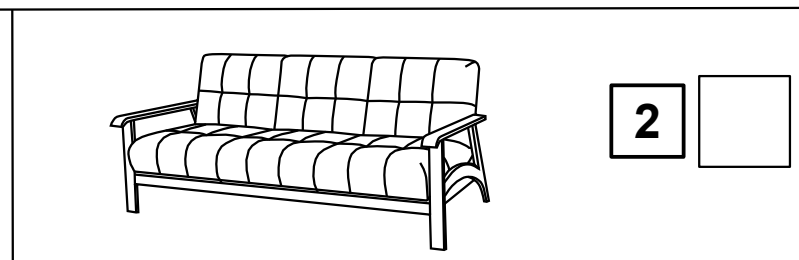
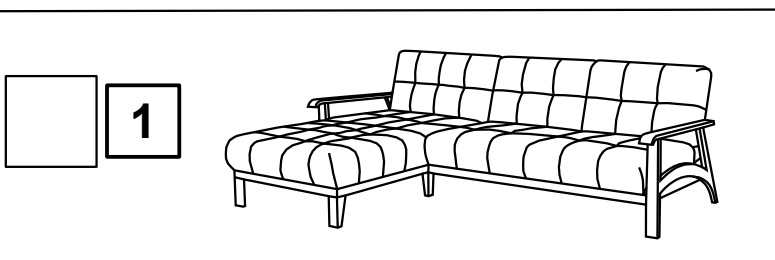
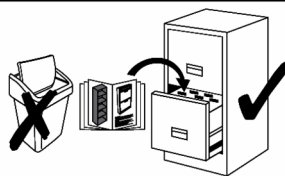

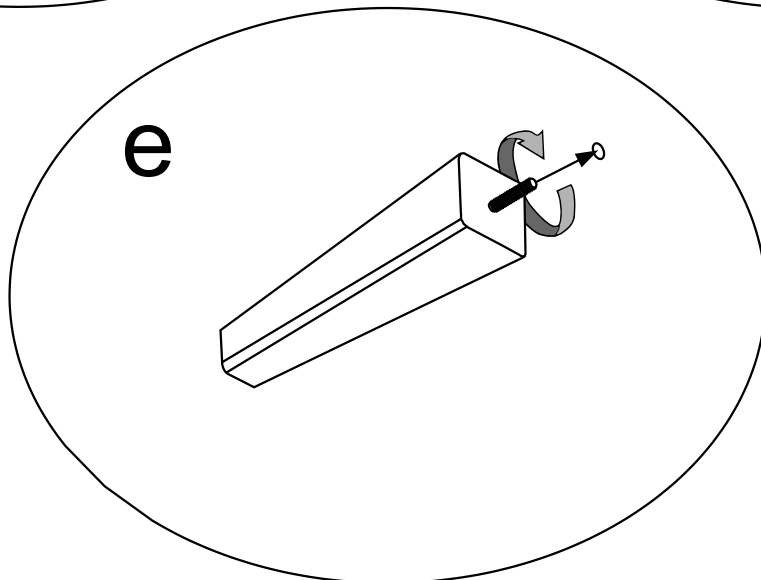
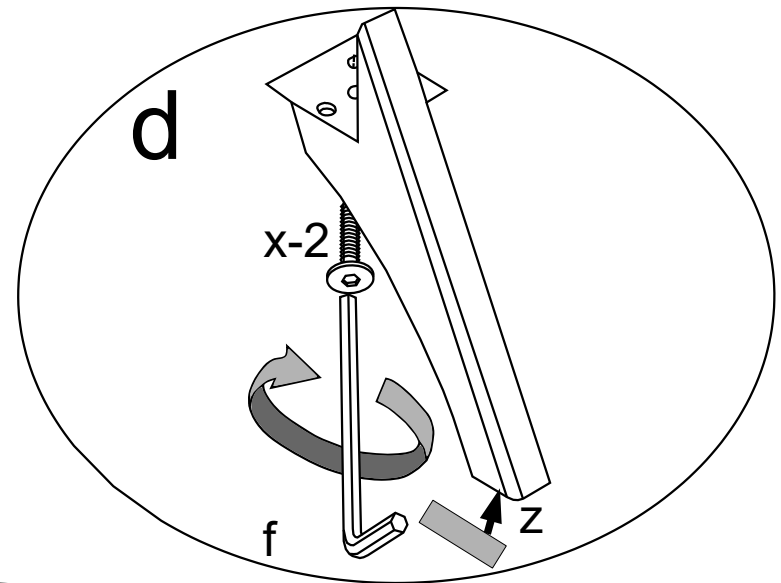
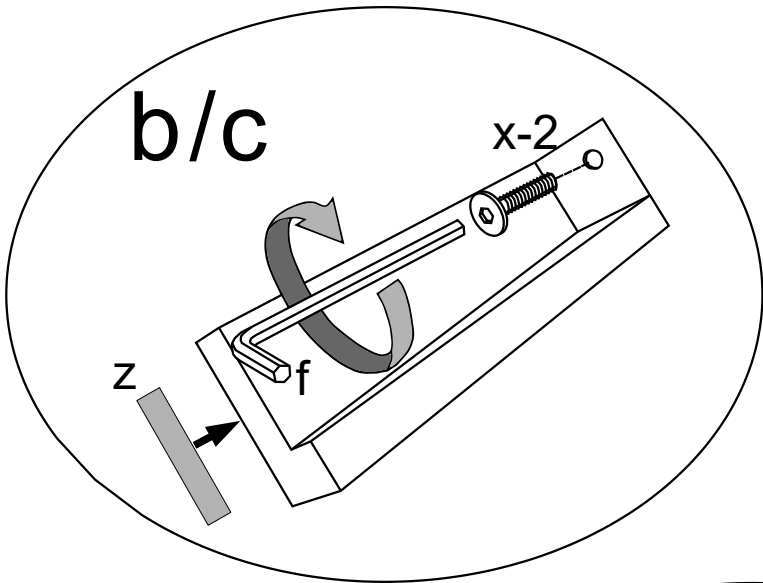
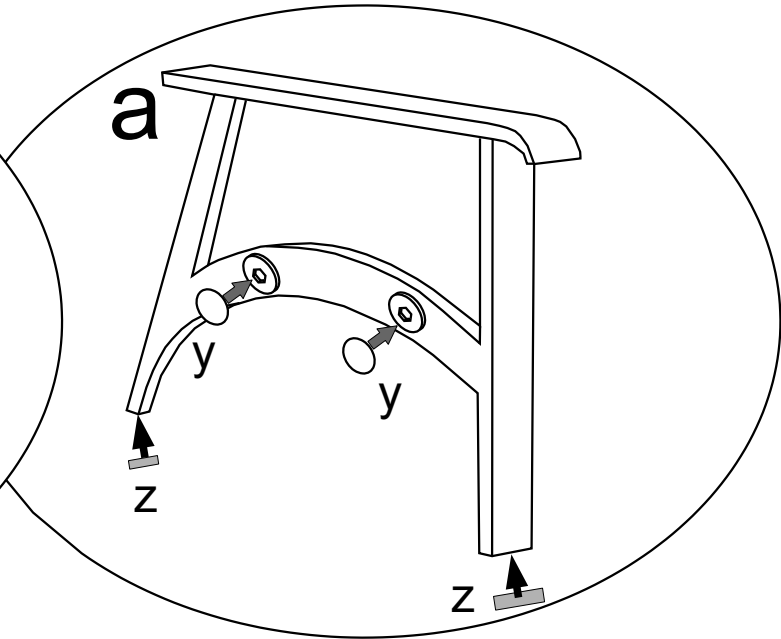
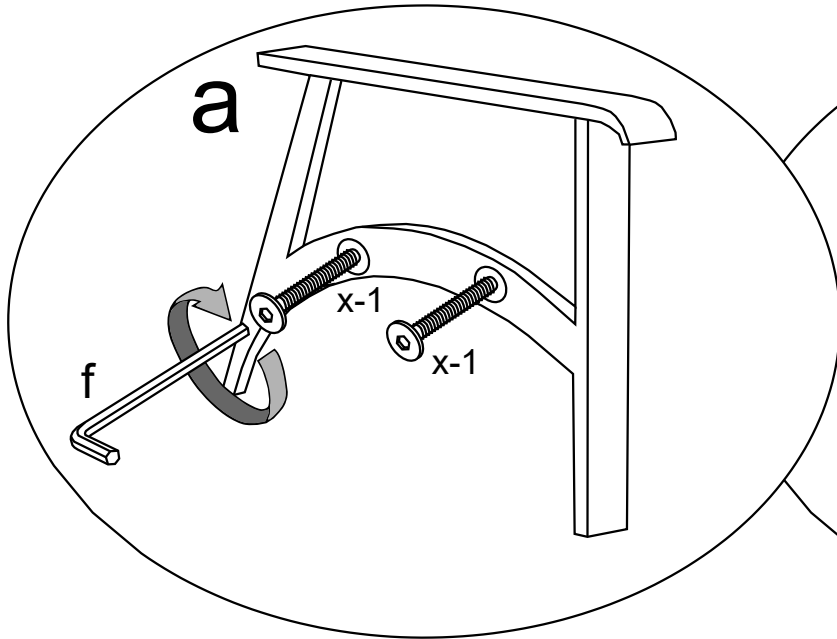
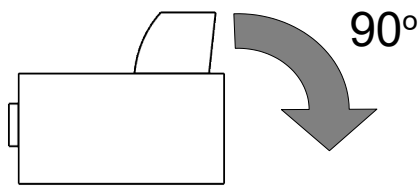



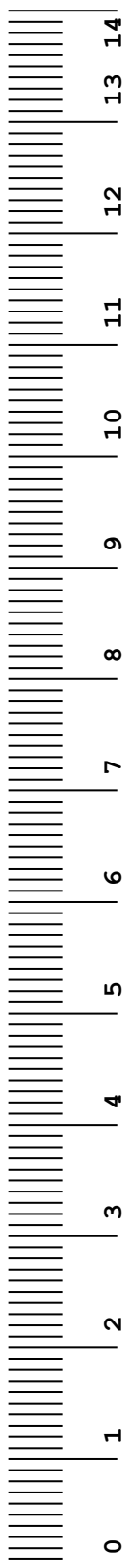
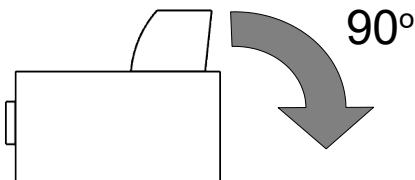
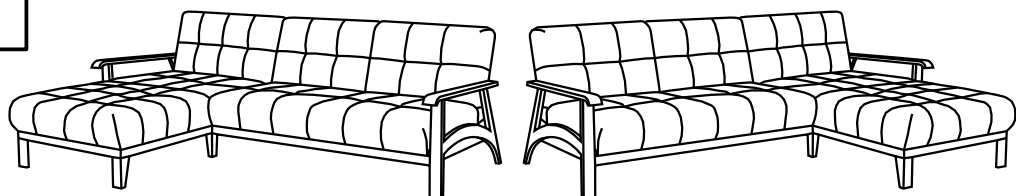

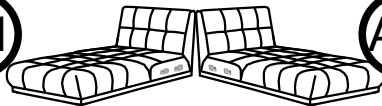
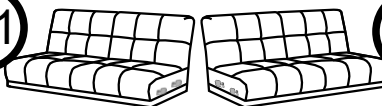
Typ · Type · Tip · Тип · Tipo · Típus





1



	<b>(A-1)</b>  <b>(A-2)</b>	<b>(B-1)</b>  <b>(B-2)</b>
<b>a</b> 	1	1
<b>b</b> 	1	-
<b>c</b> 	1	-
<b>d</b> 	1	-
<b>e</b> 	1	-
<b>x-1</b>  M8x60	2	2
<b>x-2</b>  M8x30	3	-
<b>y</b> 	2	2
<b>z</b> 	5	2
<b>f</b>  L-5	1	

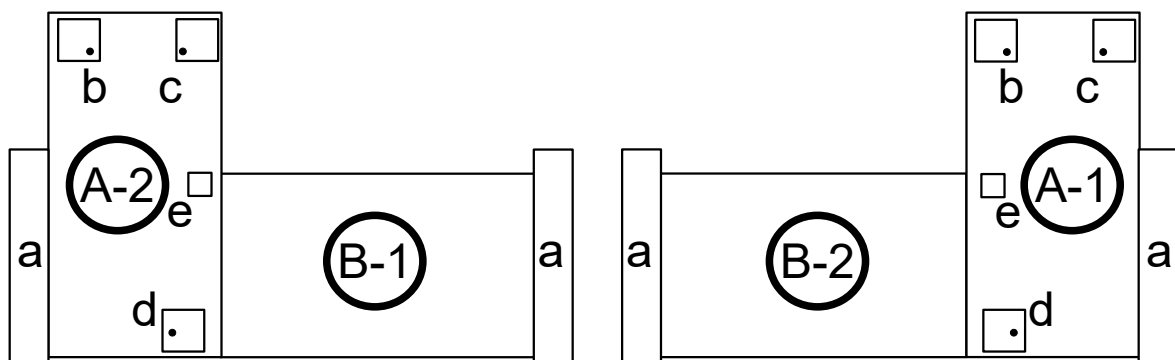

1

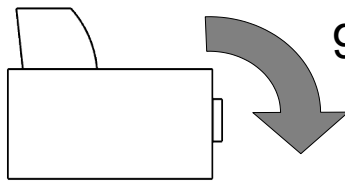
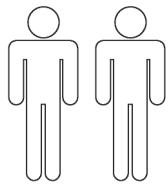

90°

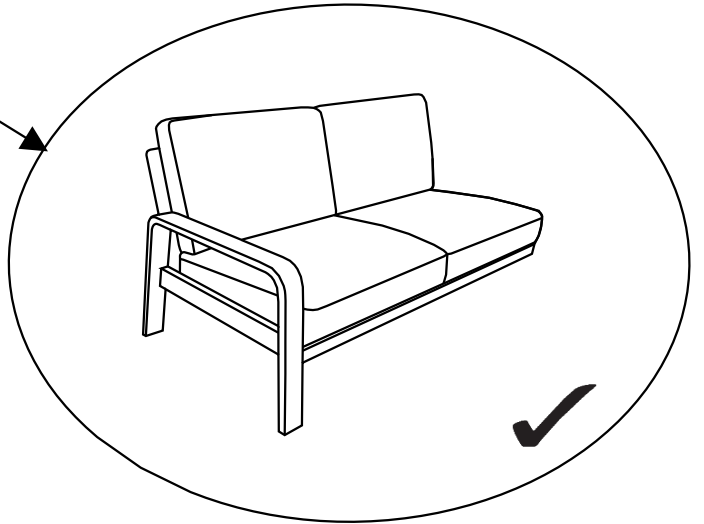
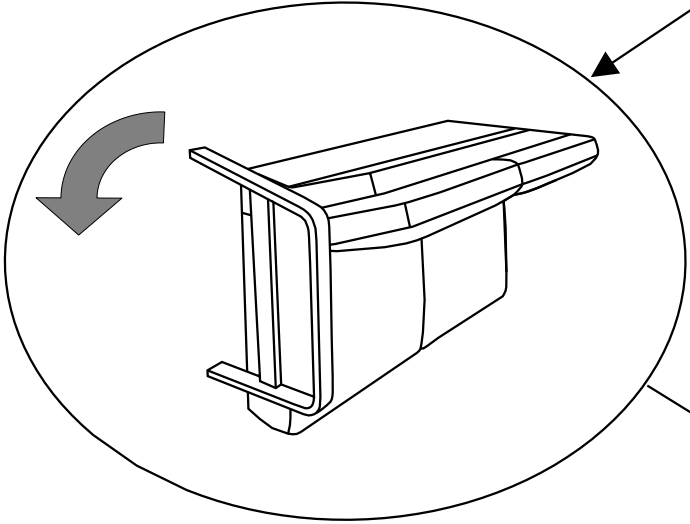
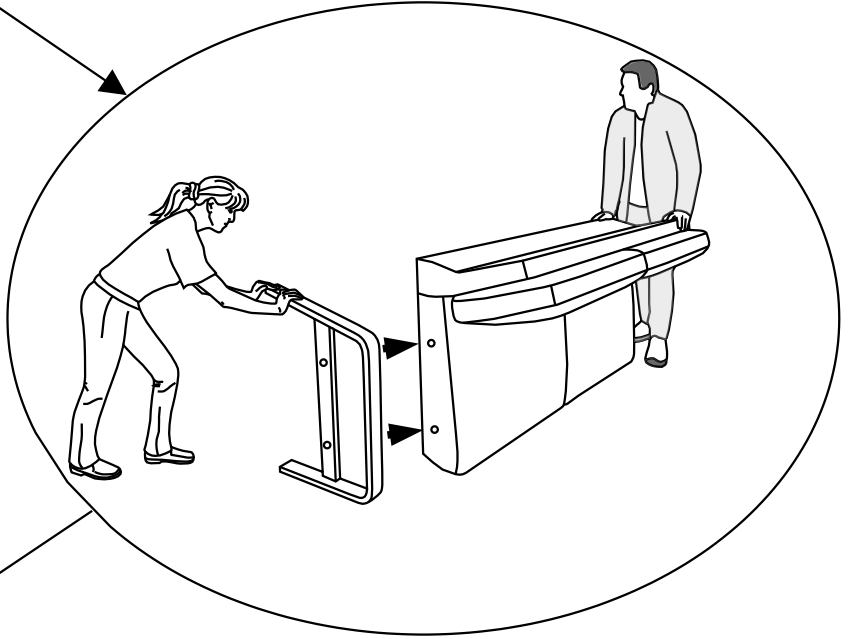
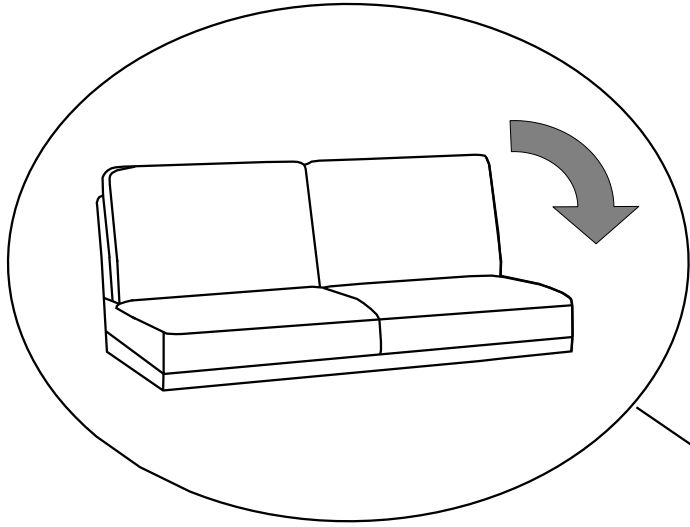

1

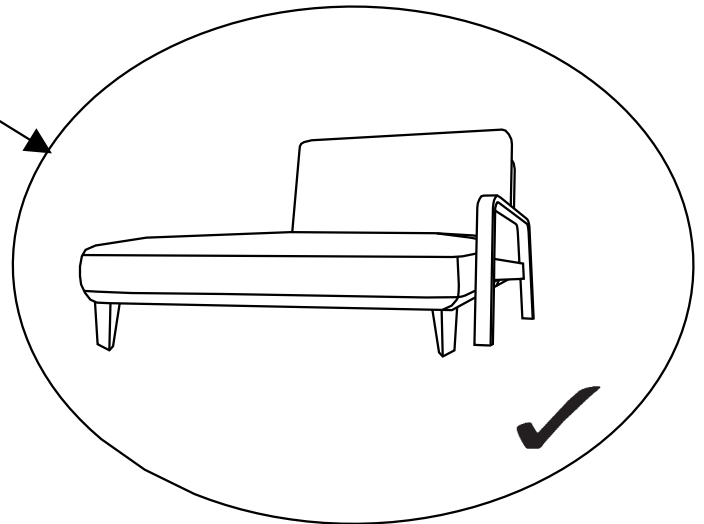
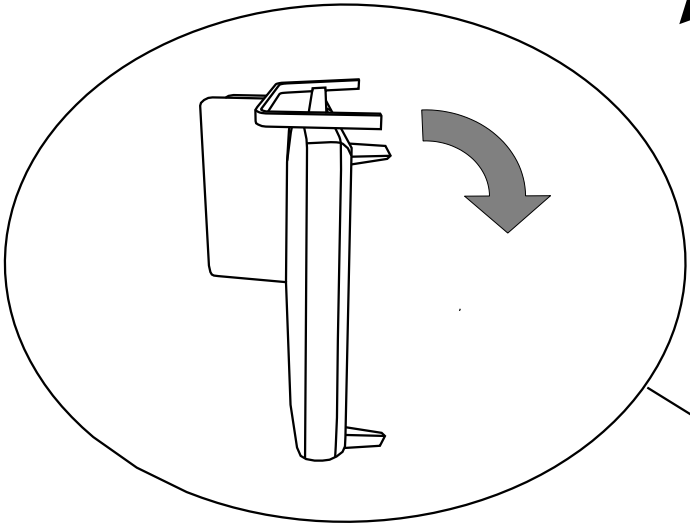
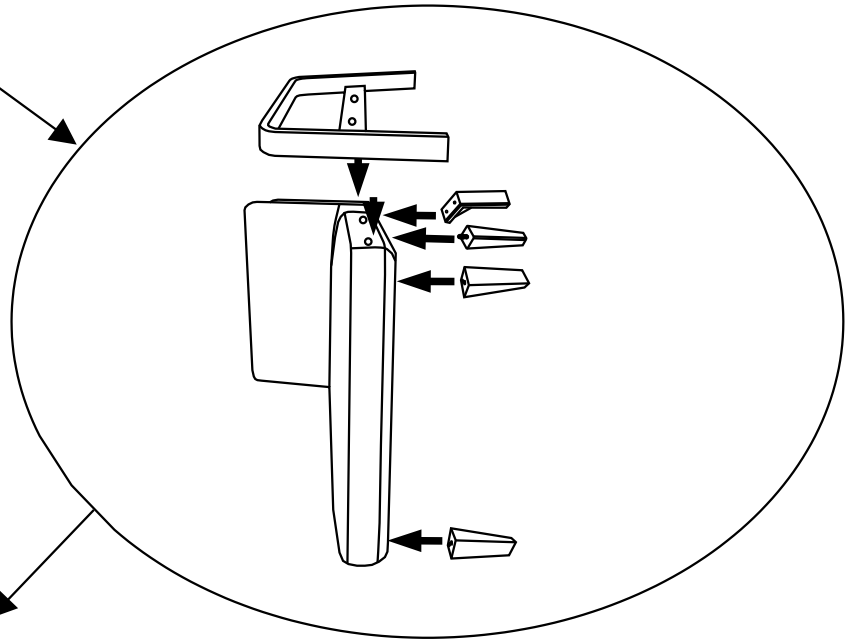
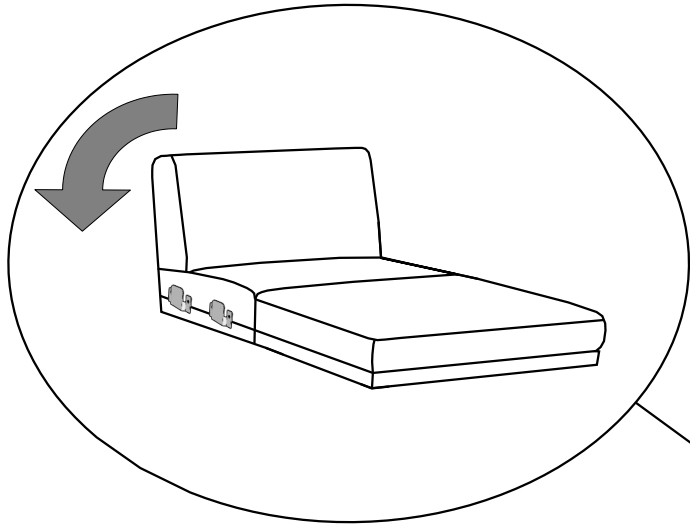
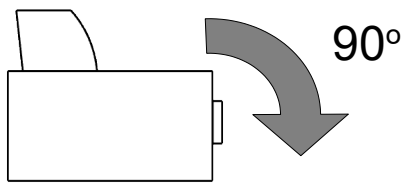
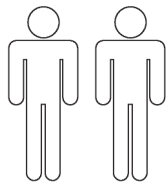

1

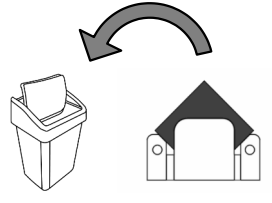
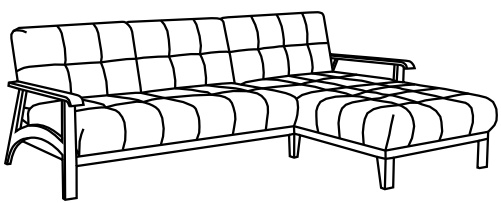

B-1

A-2

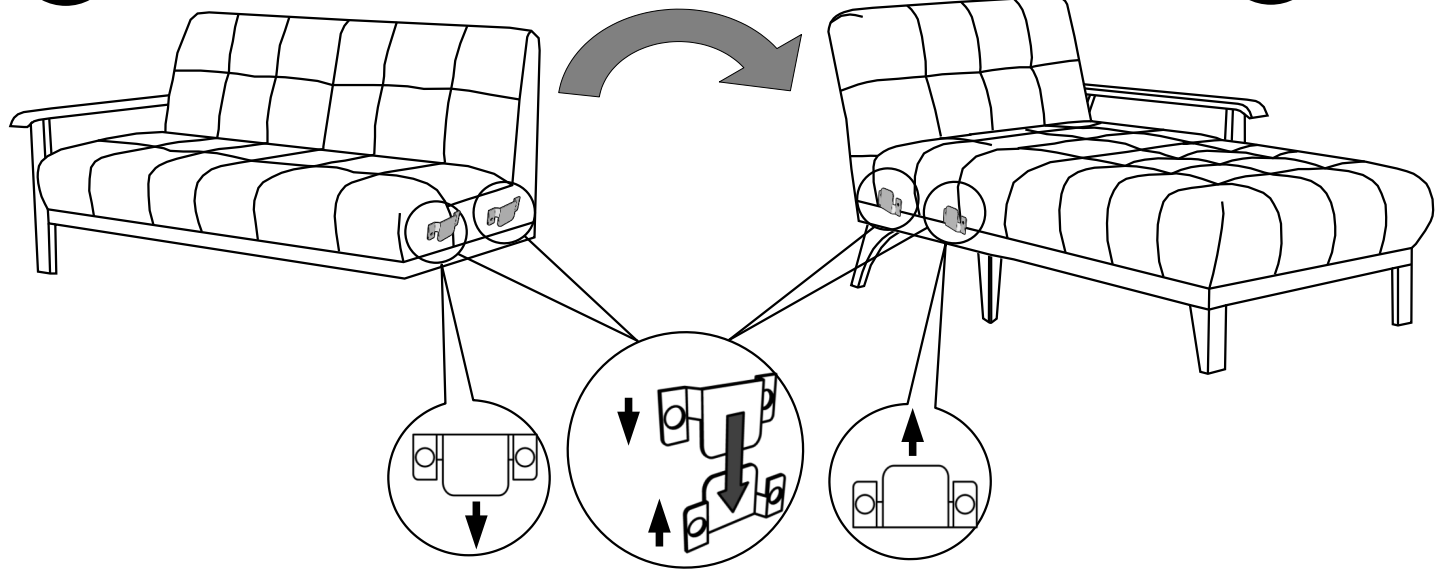

1

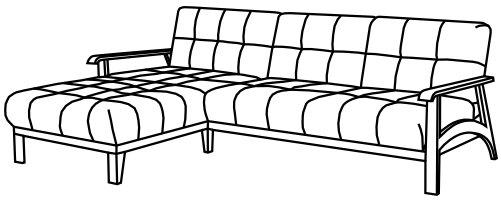

A-1

B-2

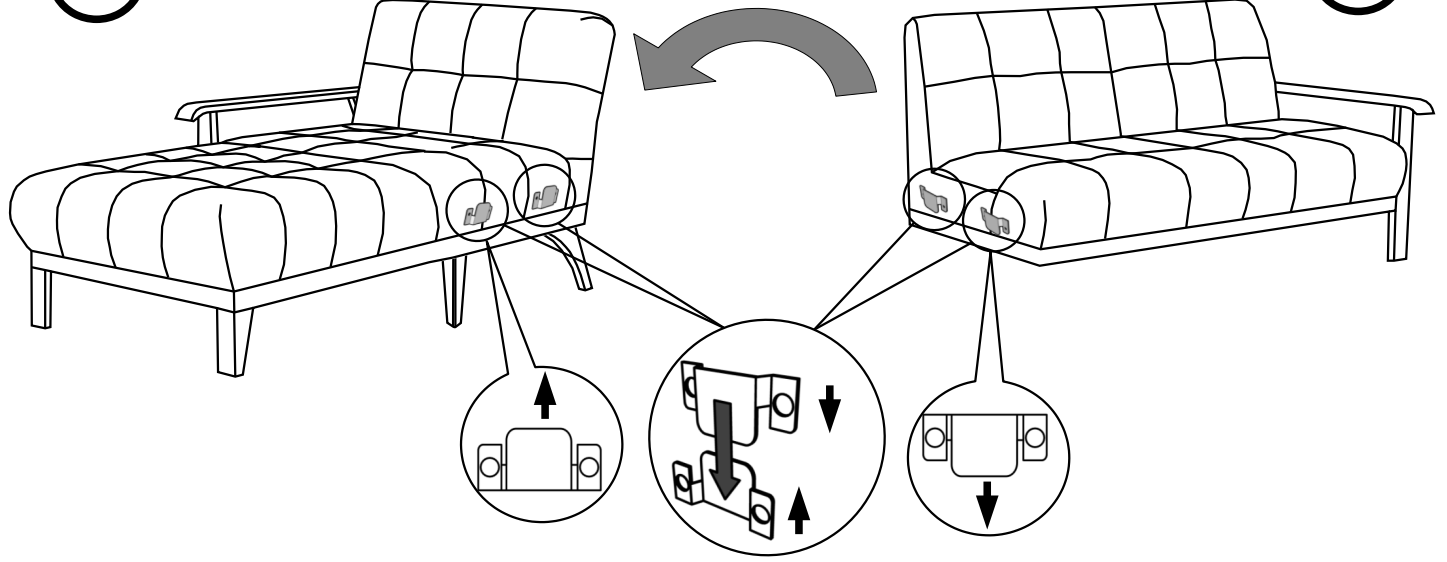



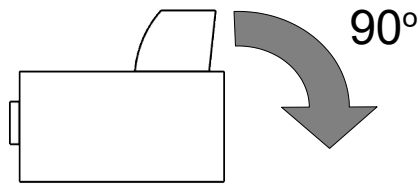

**2**

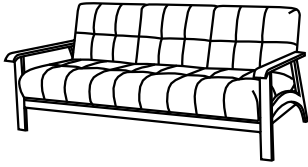

	<b>(C)</b>
<b>a</b>	2
<b>x-1</b> M8x60	4
<b>y</b>	4
<b>z-1</b>	4
<b>f</b> L-5	1

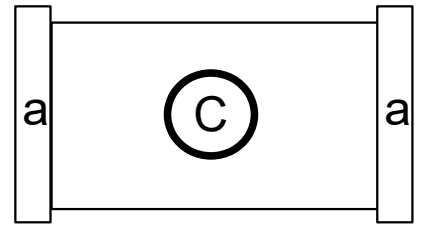

**3**



	<b>(D)</b>
<b>a</b>	2
<b>x-1</b> M8x60	4
<b>y</b>	4
<b>z-1</b>	4
<b>f</b> L-5	1

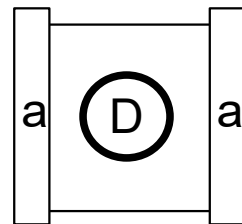



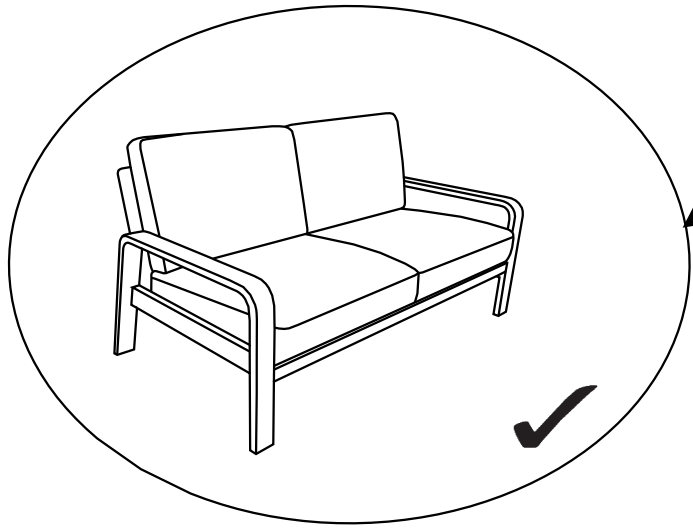
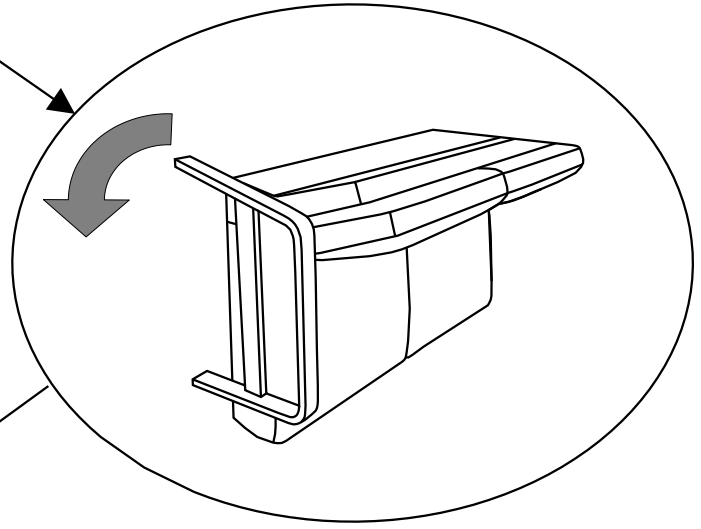
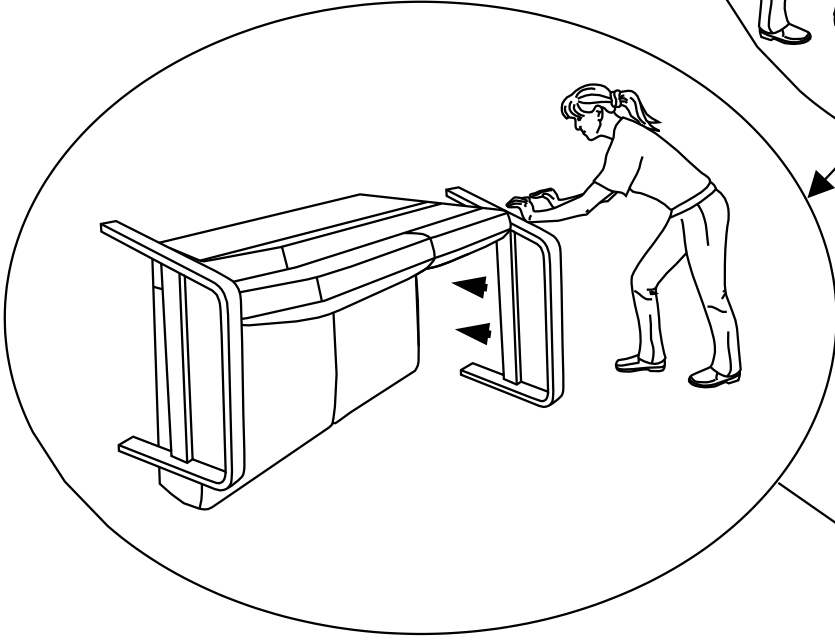
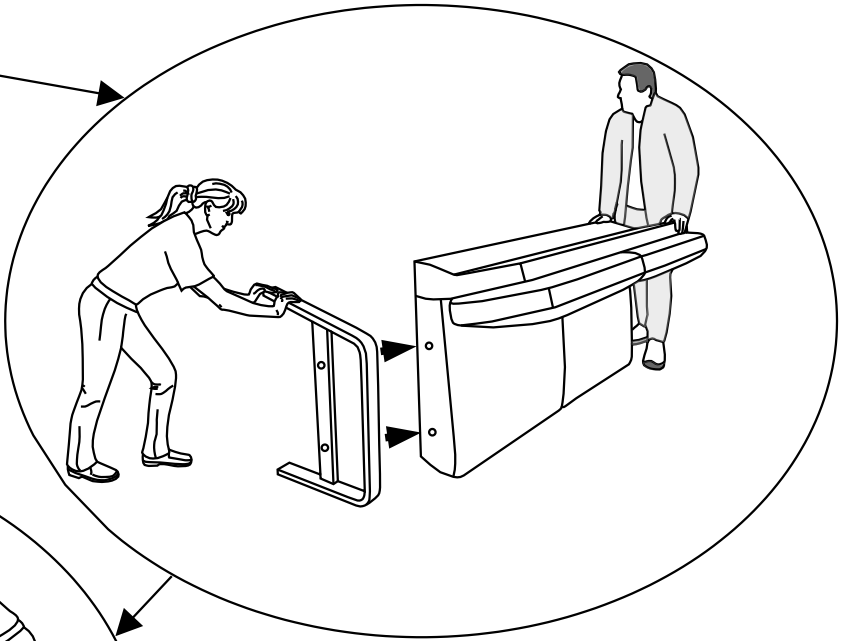
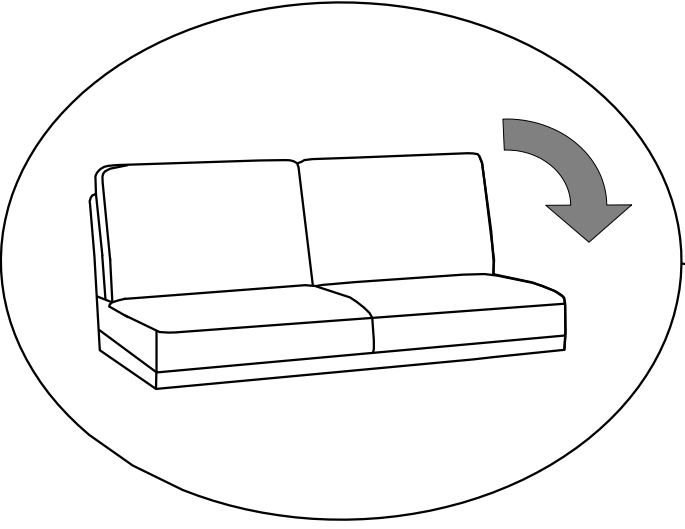
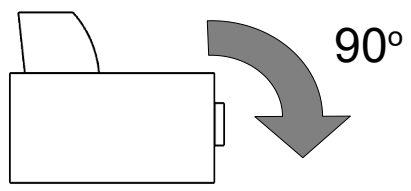
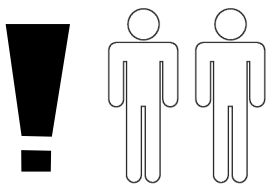

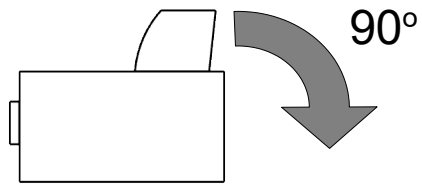

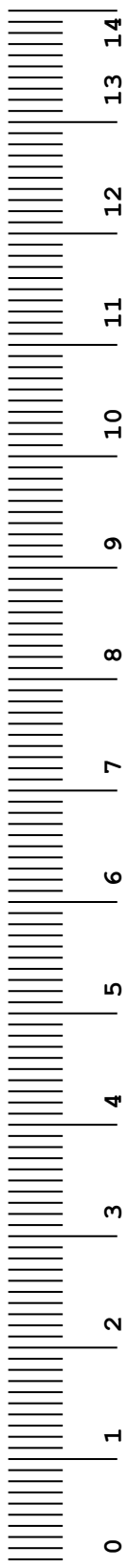
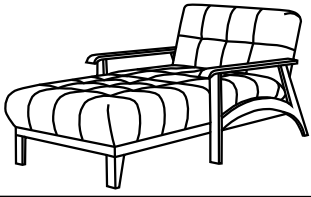

2 3

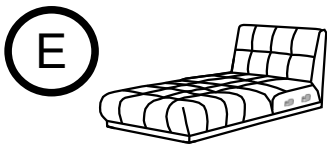



4

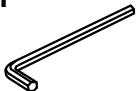

	
<b>a</b> 	2
<b>b</b> 	1
<b>c</b> 	1
<b>x-1</b>  M8x60	4
<b>x-2</b>  M8x30	2
<b>y</b> 	4
<b>z-1</b> 	6
<b>f</b>  L-5	1

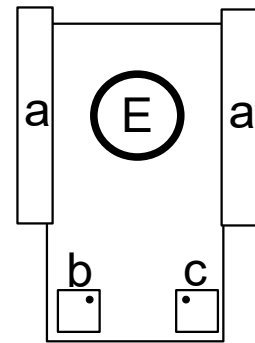

4

