

REPC-Nr.:

Service • Assistenza • Dienstverlening • Serwis
Servis • Szerviz • Сервисная служба

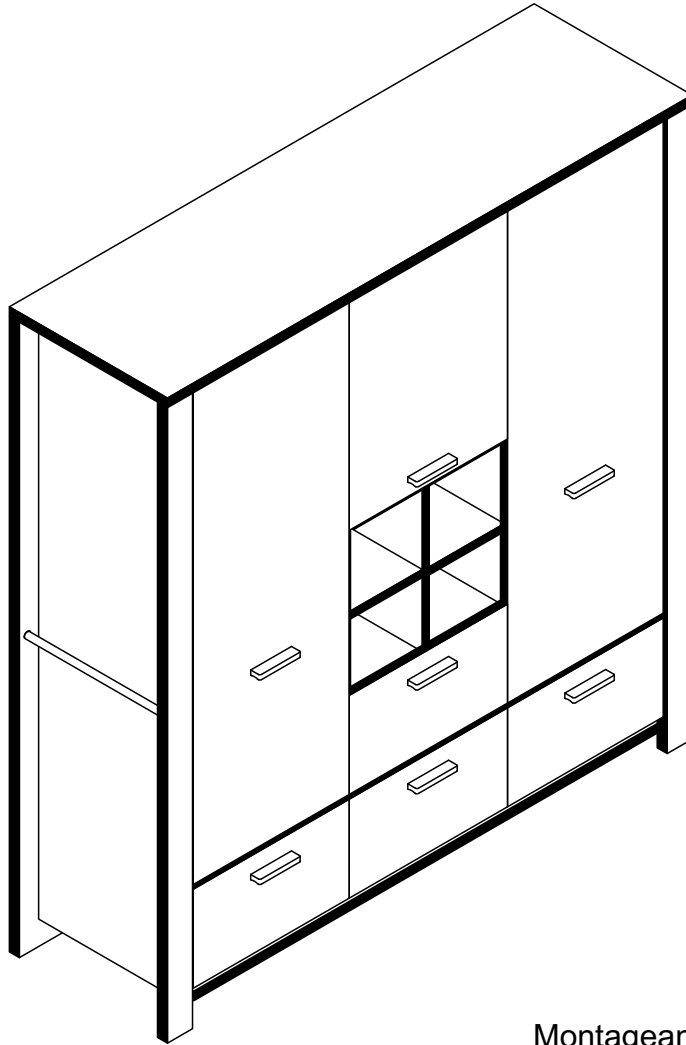

Artikel.-Nr.:

0340-KS_34

Montageanleitung.-Nr.:

MA1-00116

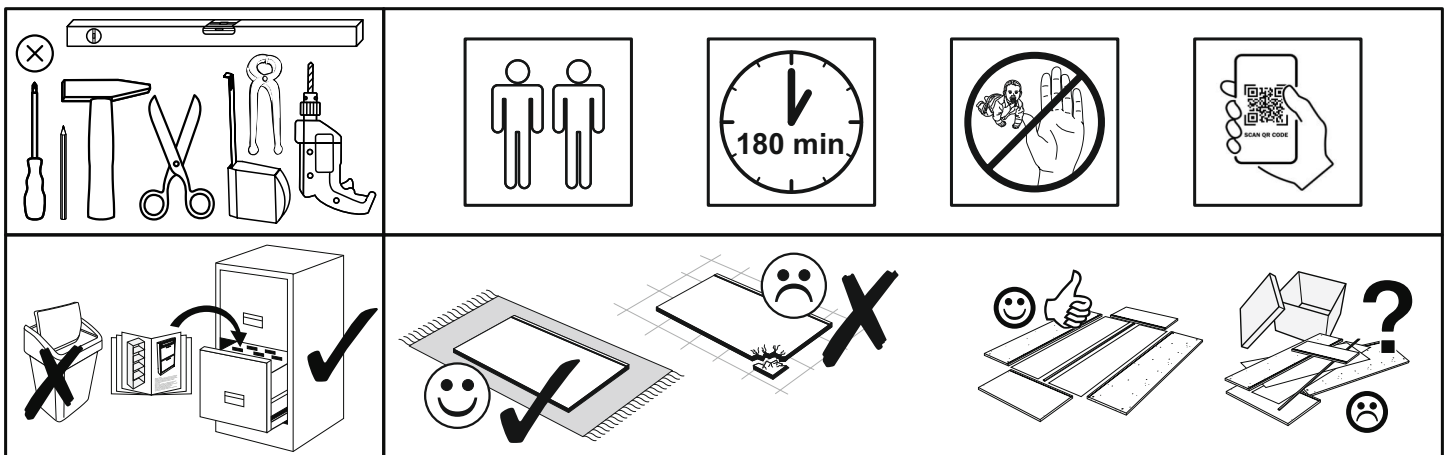

SCAN ME

Das Ersatzteil-Anforderungsformular finden Sie auf
The replacement parts requisition form you find on
<https://www.maeusbacher.de/ersatzteile/>

Beutel 0340-KS_34 0-13 Colli 1/4

B01-10 14x 6,3x50	B01-30 88x 3x16	B01-33 6x 4x17	B01-37 1x 4,5x25	B01-175 6x 4,5x60
B01-199 16x 6,3x9,5	B01-329 14x M4x22	B02-10 50x h=12mm	B02-160 20x	B03-42 2x 8er
B01-80 20x 3,5x13	B01-120 4x 3,5x45	B02-20 50x	B02-114 2x	



▶ SCAN ME

Beutel 0340-KS_34 0-23 Colli 1/4

B03-07 3x	B03-11 8x	B03-43 6x 15er
--------------	--------------	----------------------

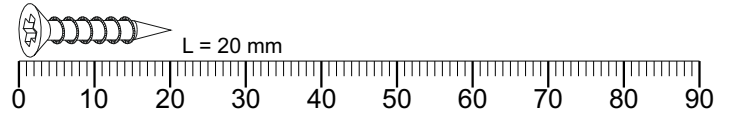

Beutel 0340-KS_34 0-33 Colli 1/4

B01-70 8x 3x30	B02-08 16x h=10mm	B02-20 16x	B02-103 12x 8x30	B05-130 1x	B08-80 2x
B06-440 7x					

Colli 1/4

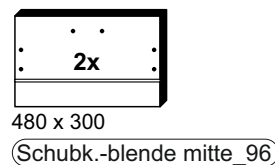
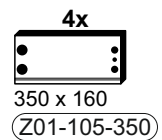
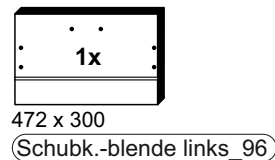
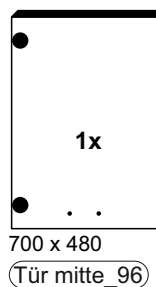
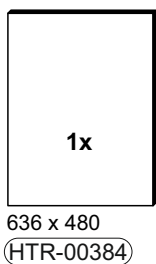
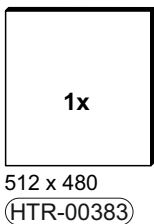
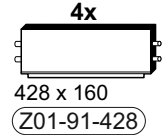
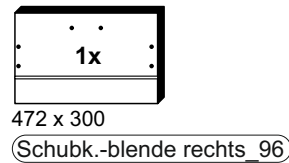
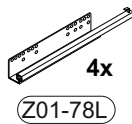
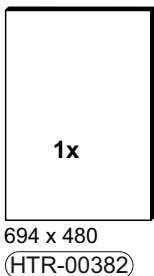
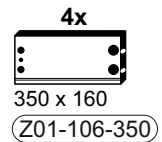
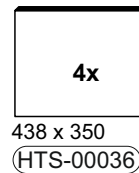
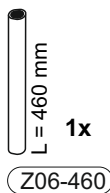
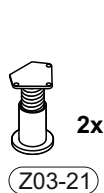
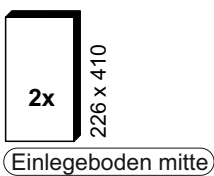

Colli 2/4

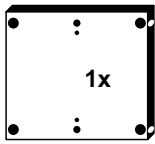

468 x 422

(Mittelboden mitte oben)

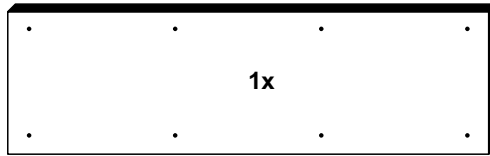

1590 x 471

(Oberboden)

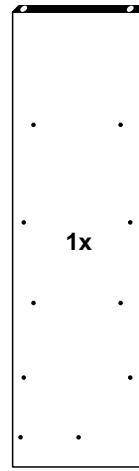

1504 x 422

(Mittelseite links)

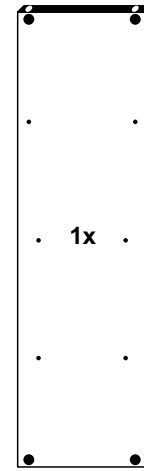

1504 x 422

(Mittelseite rechts)

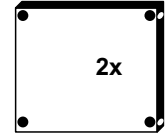

468 x 410

(Mittelboden li u re)

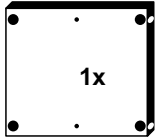

468 x 422

(Mittelboden mitte unten)

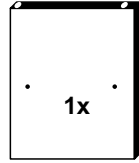

498 x 410

(Mittelseite mitte)

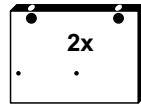

304 x 422

(Mittelseite unten)

Colli 3/4



1930 x 76

(Längsleiste vorne)

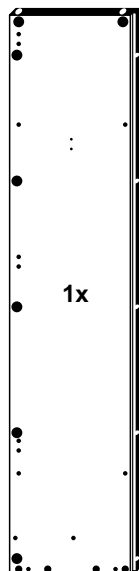

1846 x 419

(Seite links)

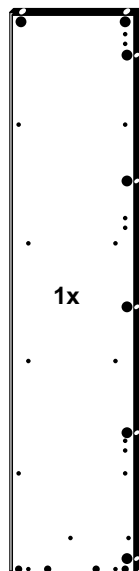

1846 x 419

(Seite rechts)

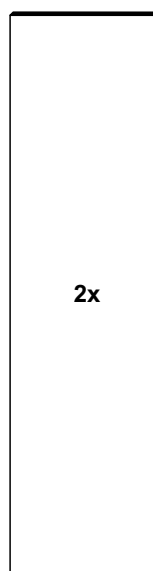

1845 x 480

(HTR-00339)

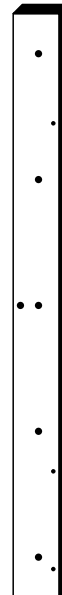

1930 x 152

(Längsleiste hinten li)



1930 x 152

(Längsleiste hinten re)

Colli 4/4

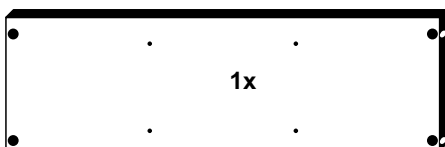

1434 x 440

(Mittelboden)

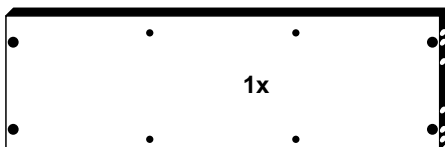

1434 x 440

(Boden)

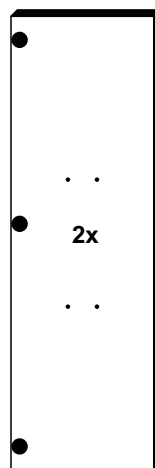

1500 x 472

(Tür li u re_96)

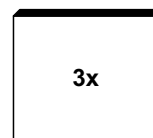

468 x 410

(Einlegeboden)

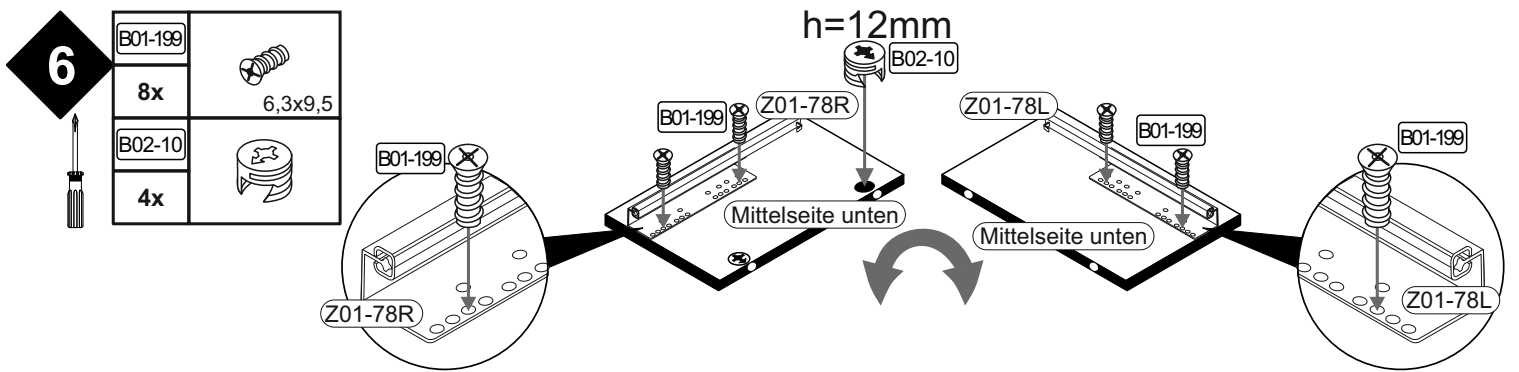
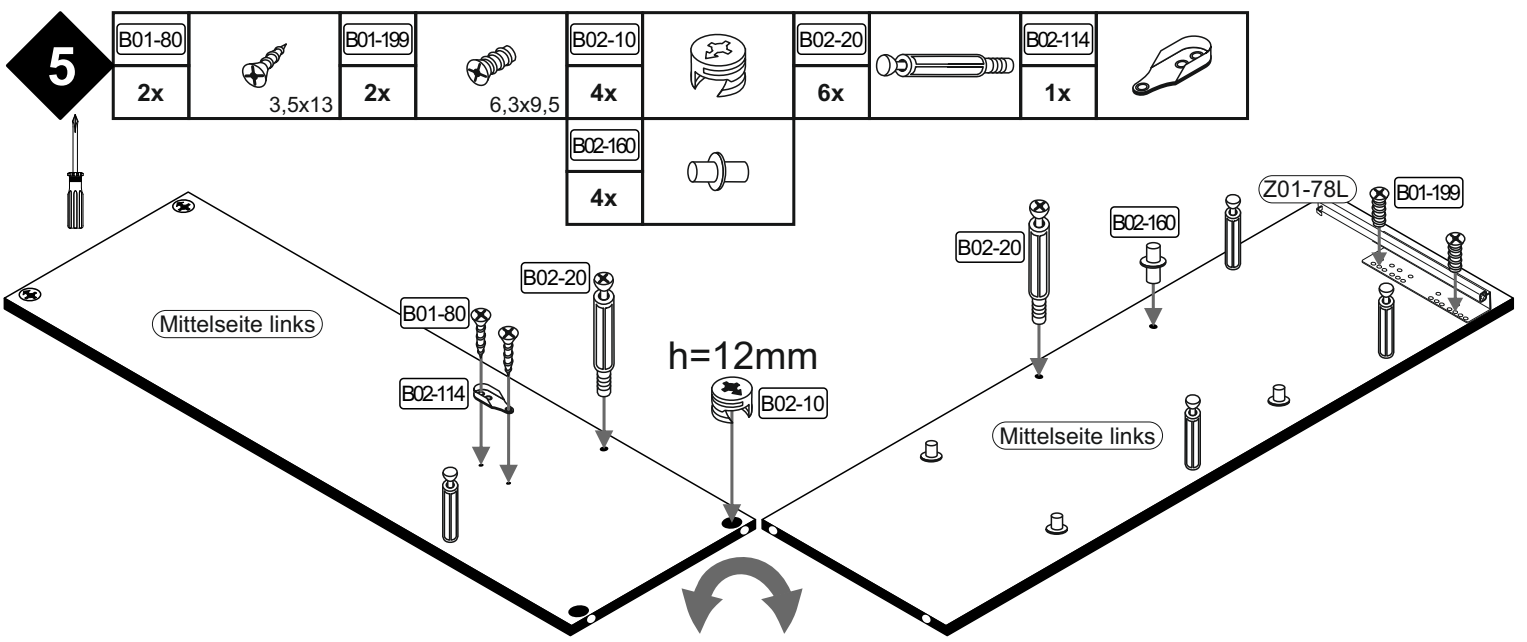
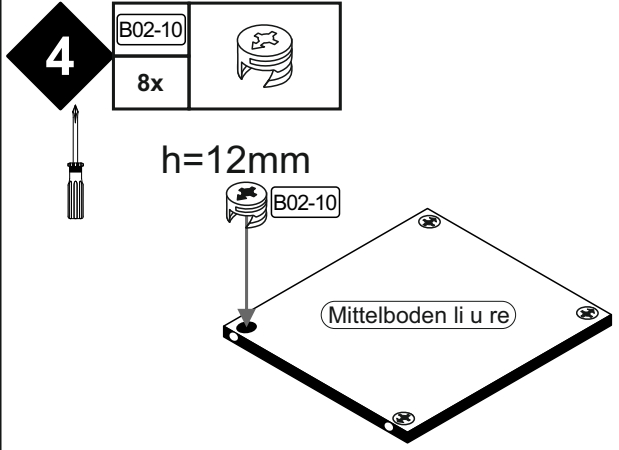
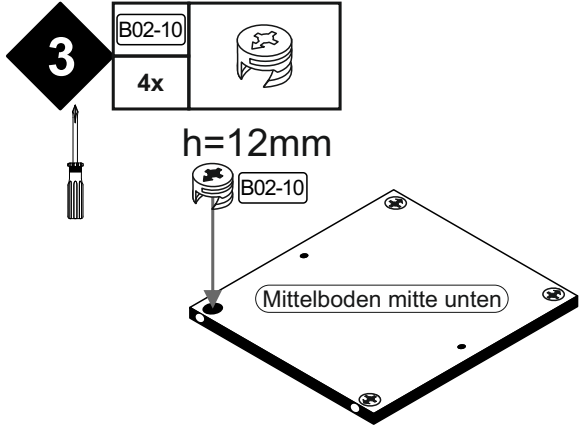
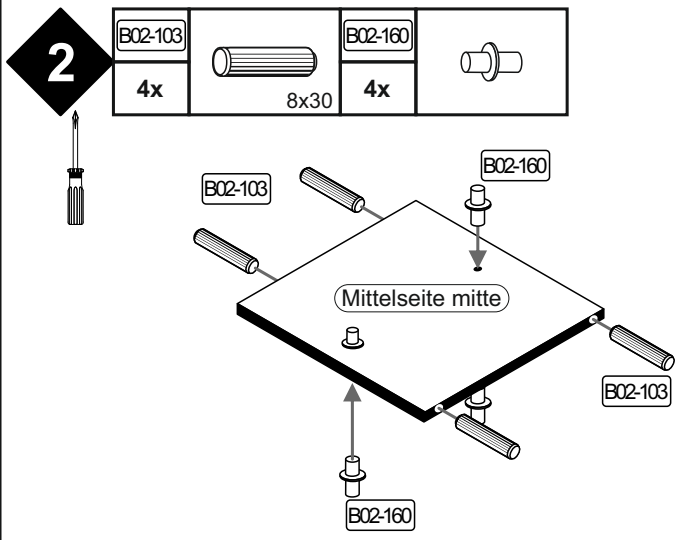
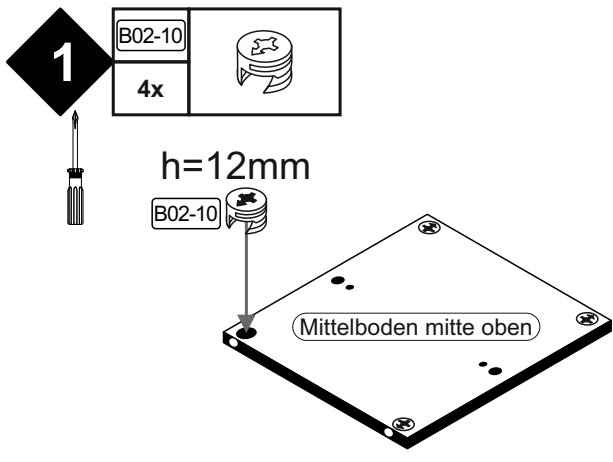

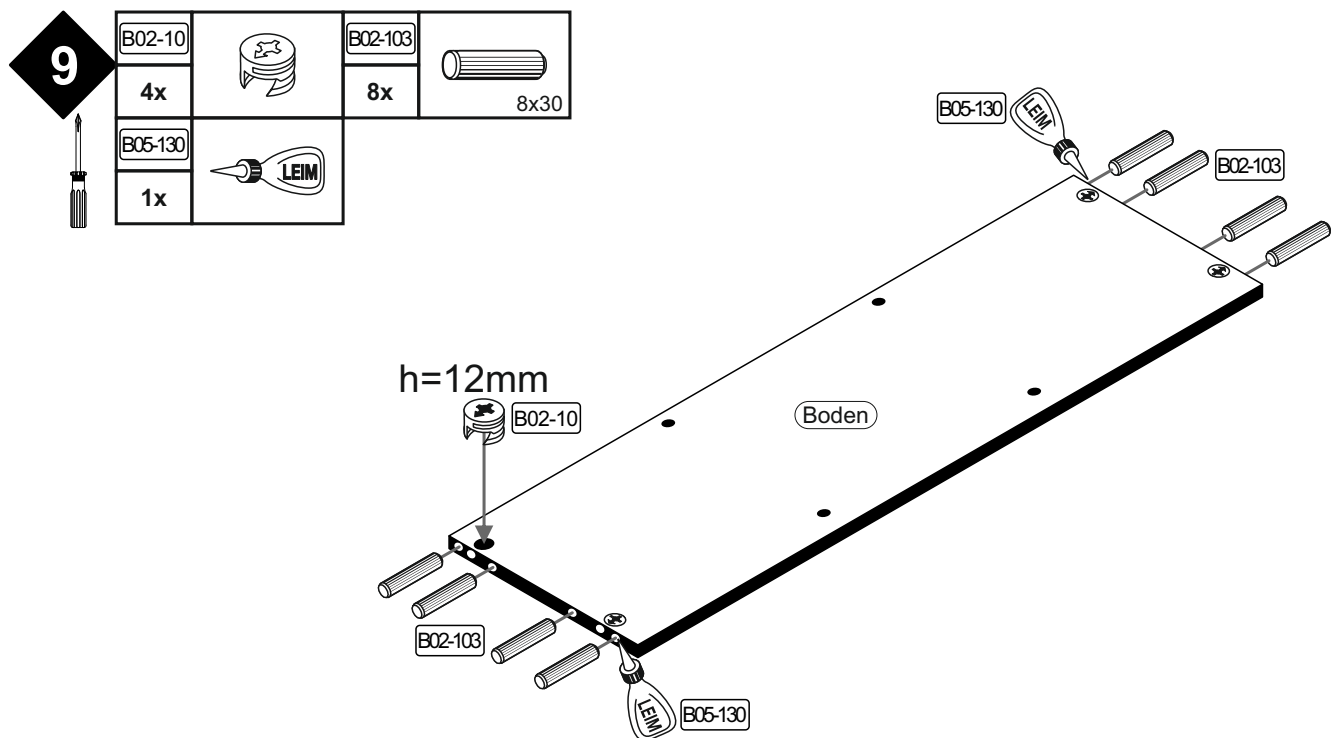
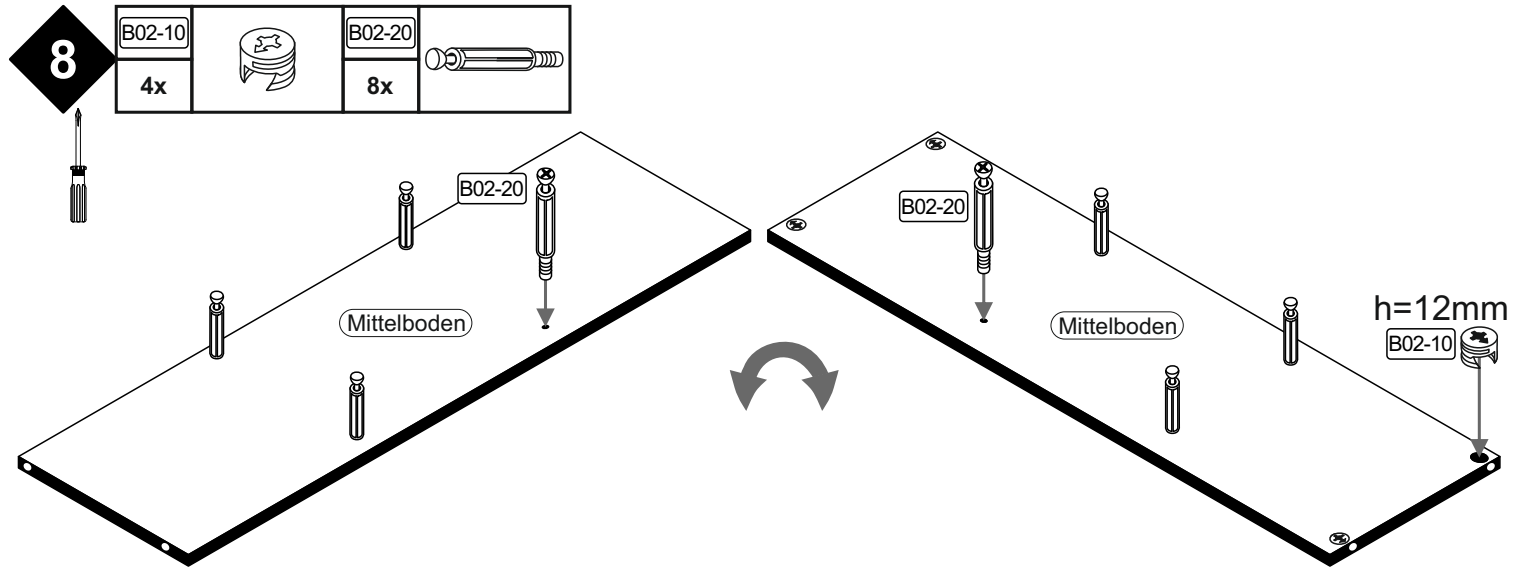
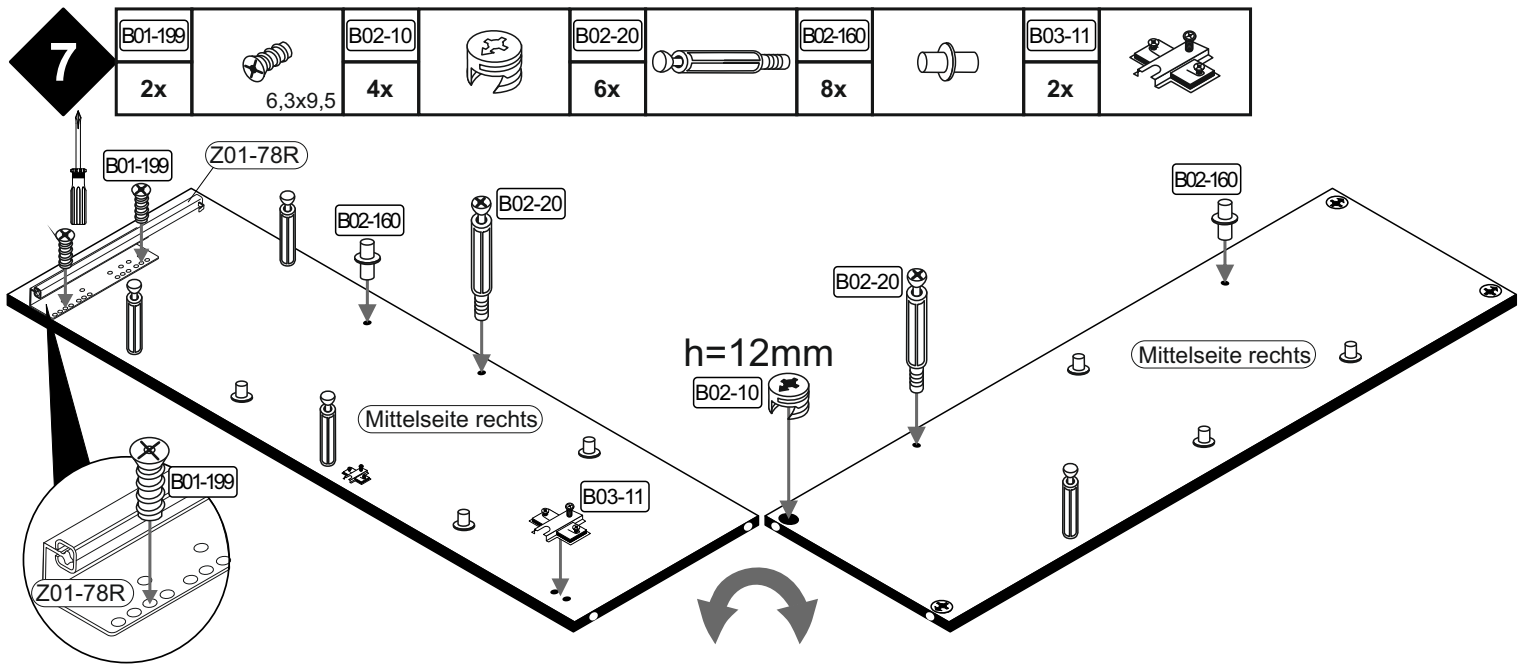





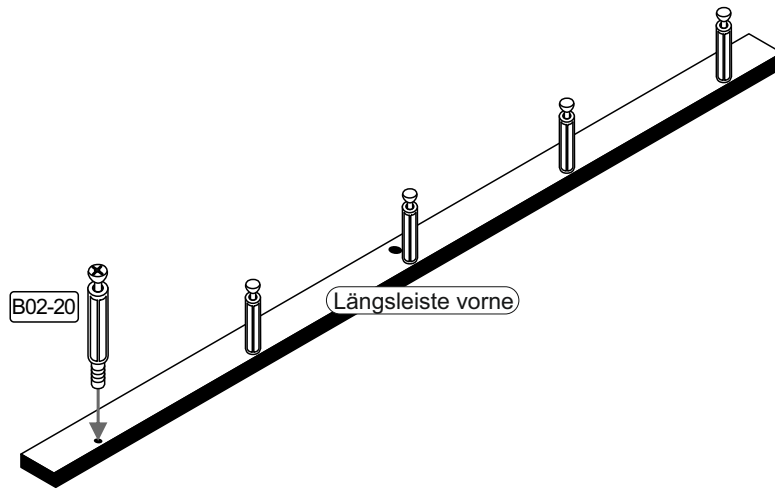

10

B02-20	
10x	

11

B01-80		B01-199		B02-10		B02-20		B02-114	
2x	3,5x13	2x	6,3x9,5	7x		6x		1x	

B03-11	
3x	



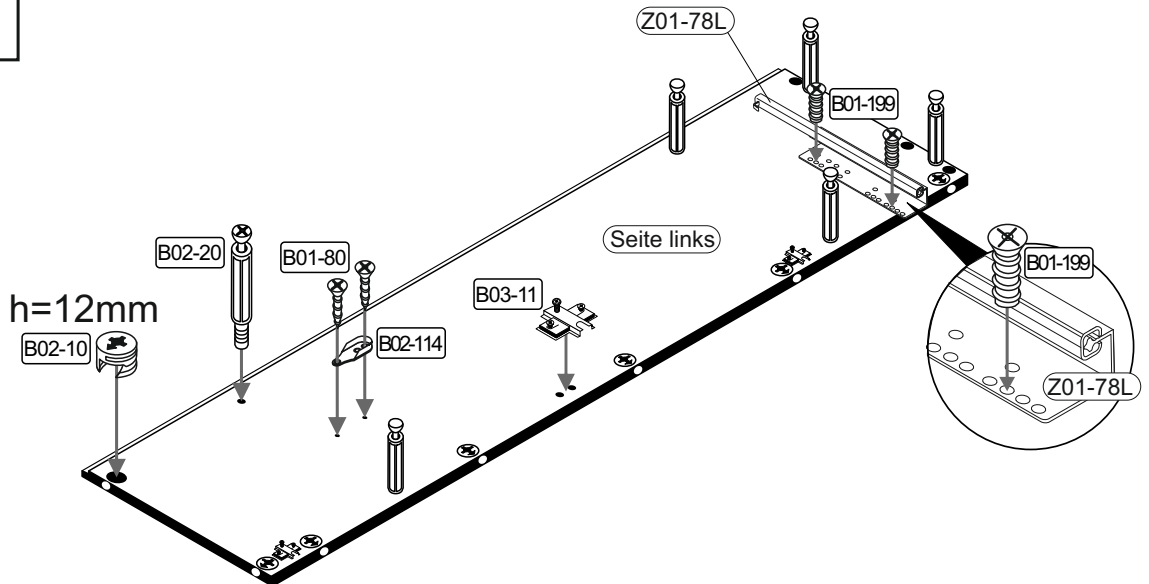

12

B01-199	
2x	6,3x9,5

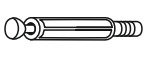
B02-10	
7x	

B02-20	
6x	

B02-160	
4x	

B03-11	
3x	

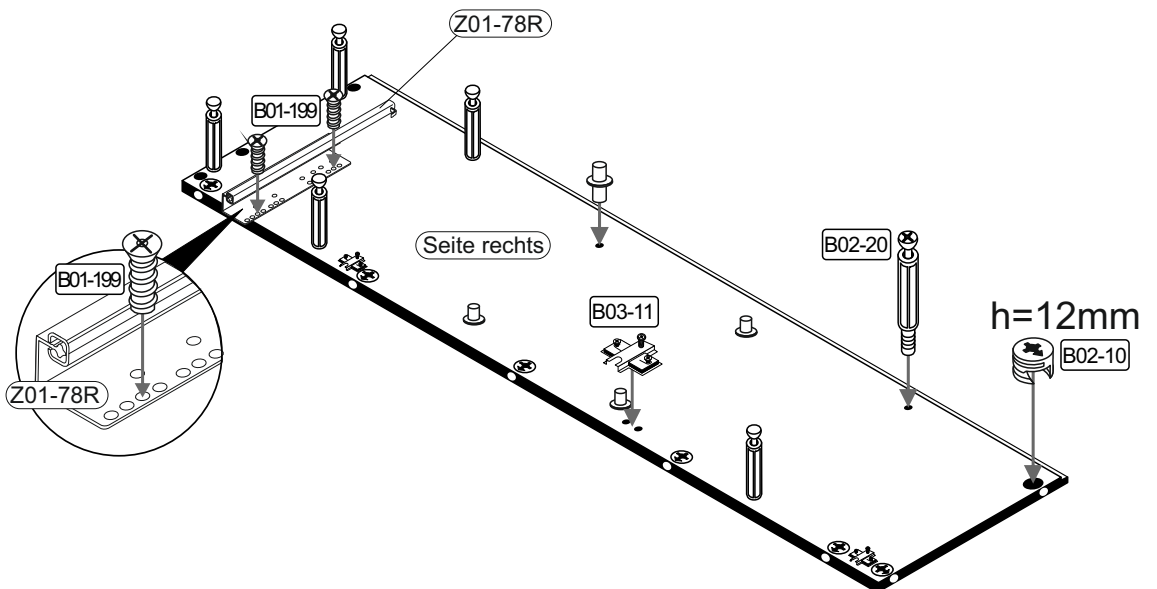
13

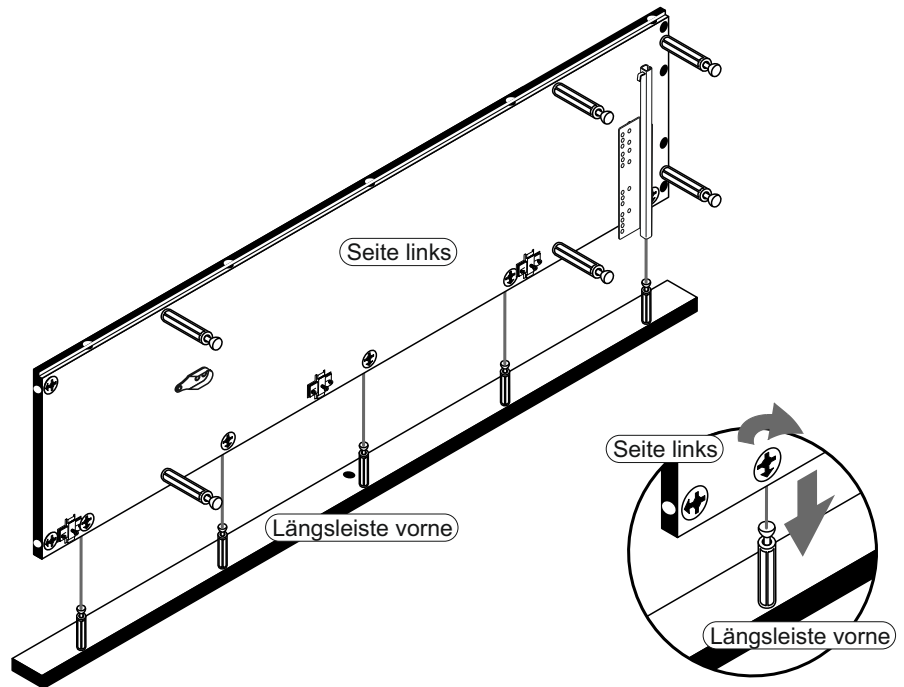

14

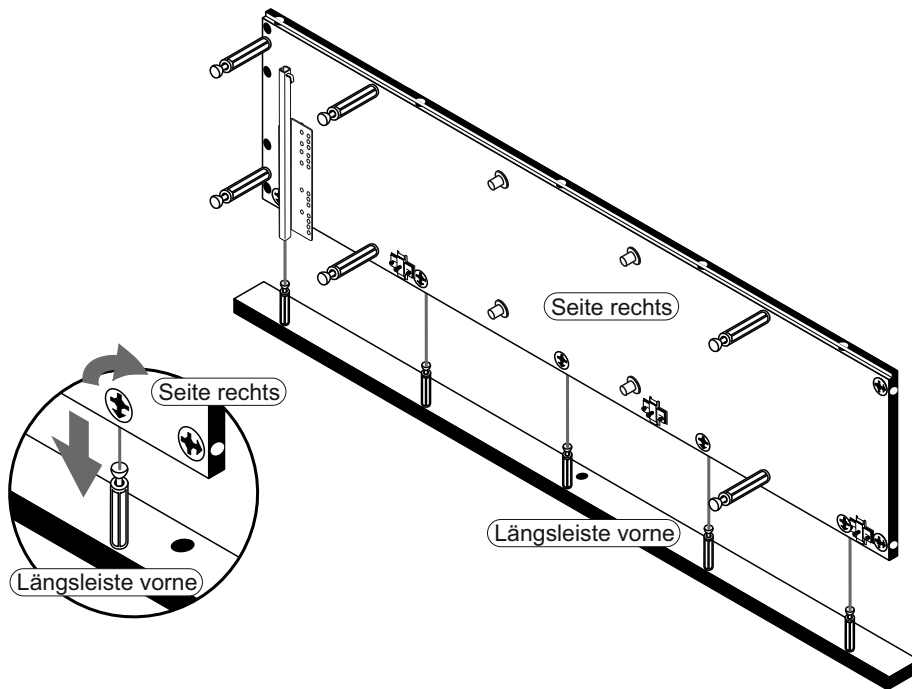

15

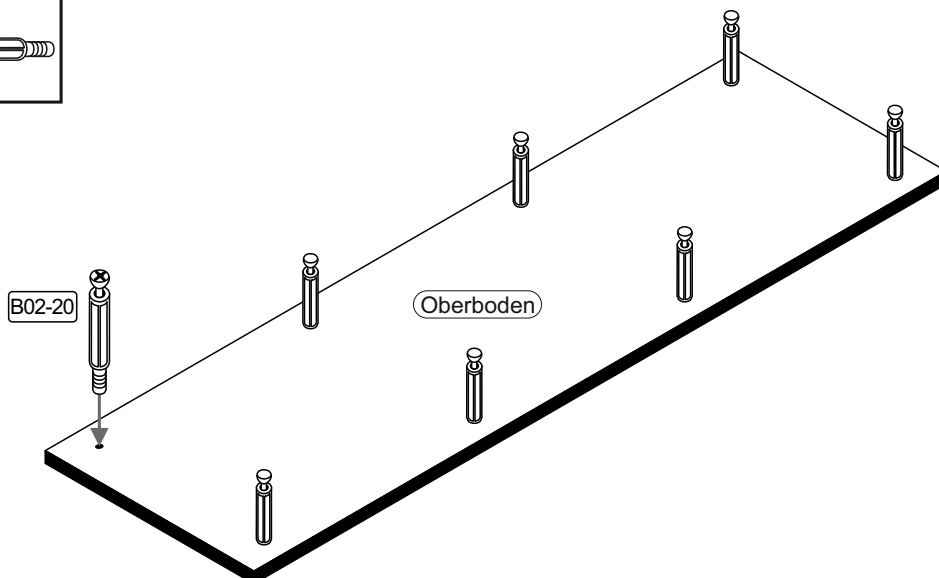
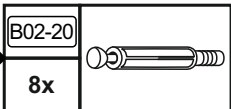

16

B01-80		12x	3,5x13
B03-43		6x	15er

Scharniere B03-43 aus Beutel 2/3

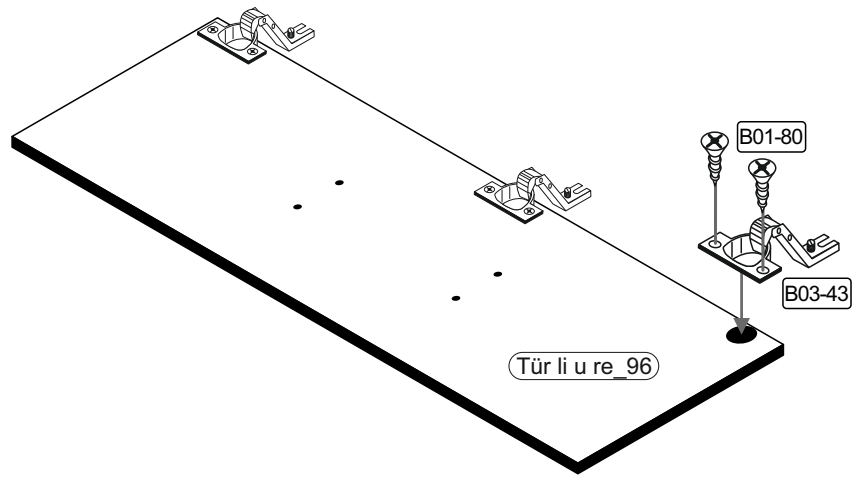

17

B01-80		B01-329	
4x	3,5x13	2x	M4x22
B03-42		B06-440	
2x	8er	1x	

Scharniere B03-42 aus Beutel 1/3

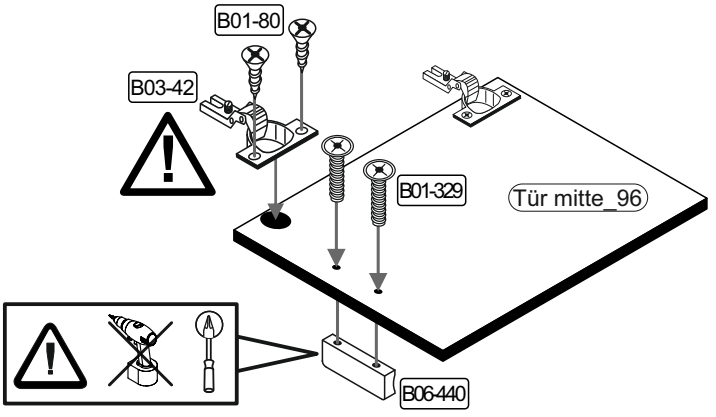

18

B01-329		B02-08		B02-20		B06-440	
8x	M4x22	16x	h=10mm	16x		4x	

Schubk.-blende links_96

Schubk.-blende mitte_96

Schubk.-blende rechts_96

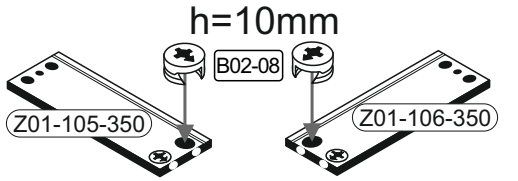
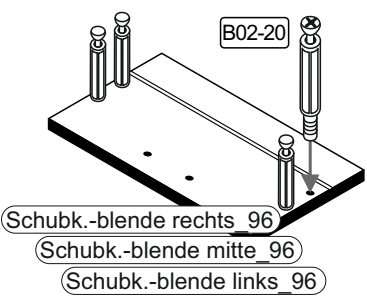
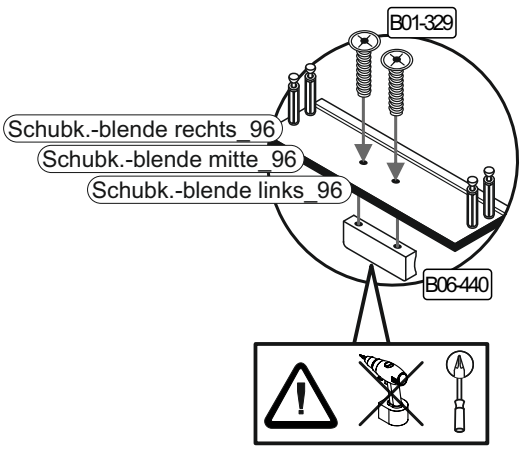
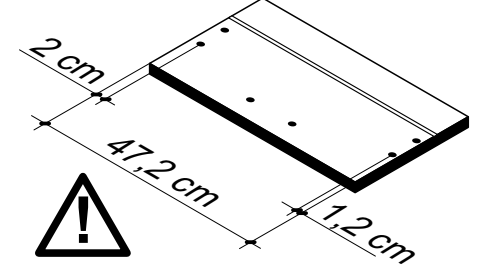
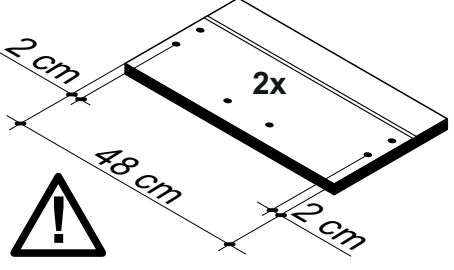
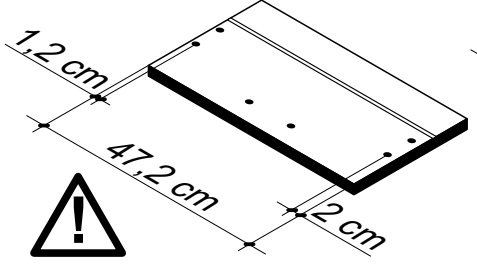

19

B01-70	
8x	3x30

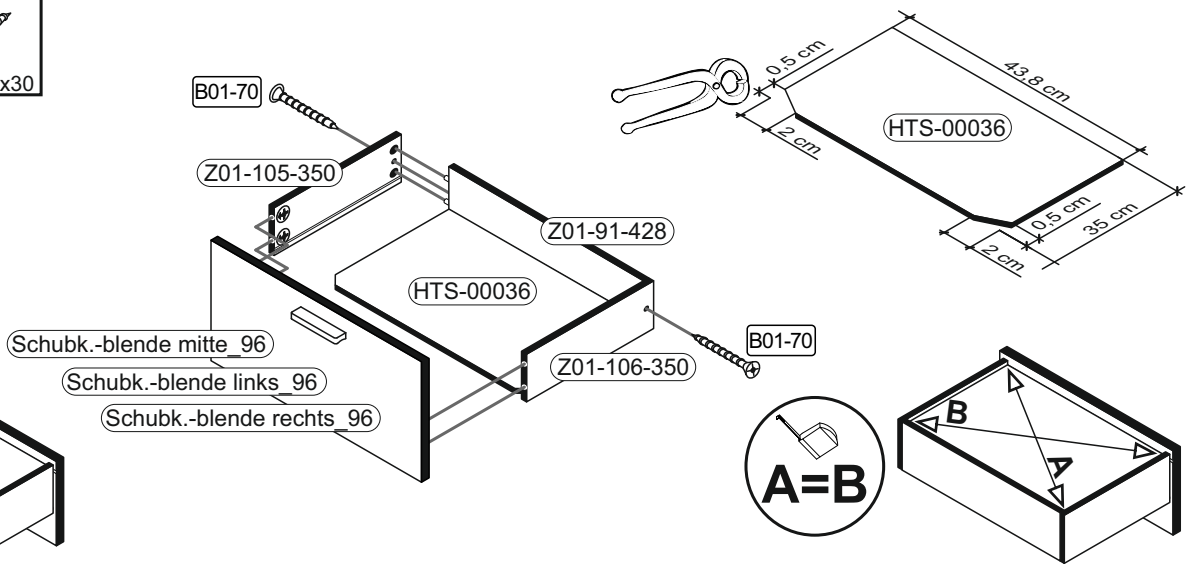
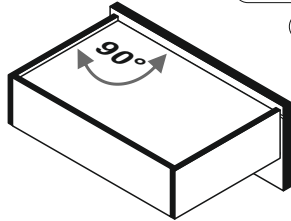
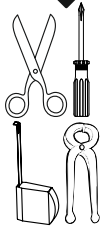

20

B01-120	
4x	3,5x45

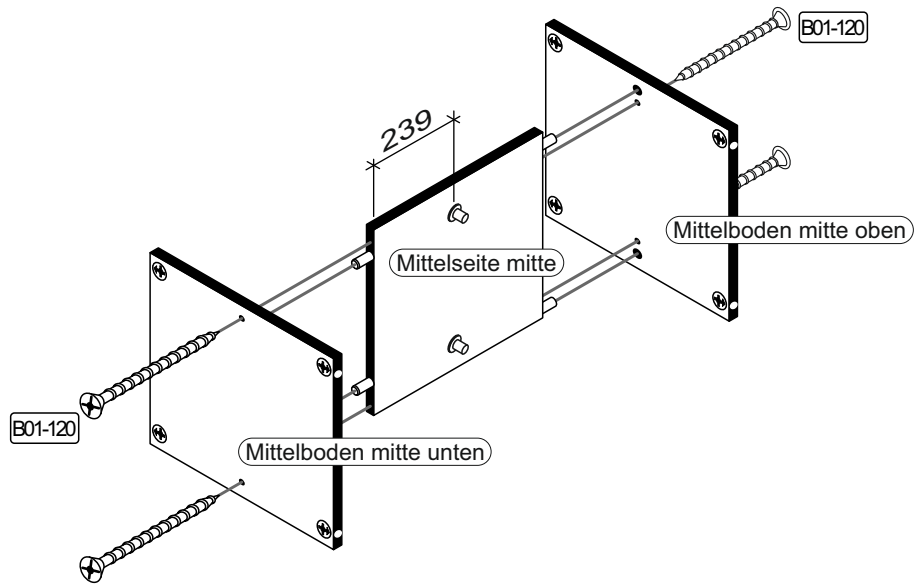

21

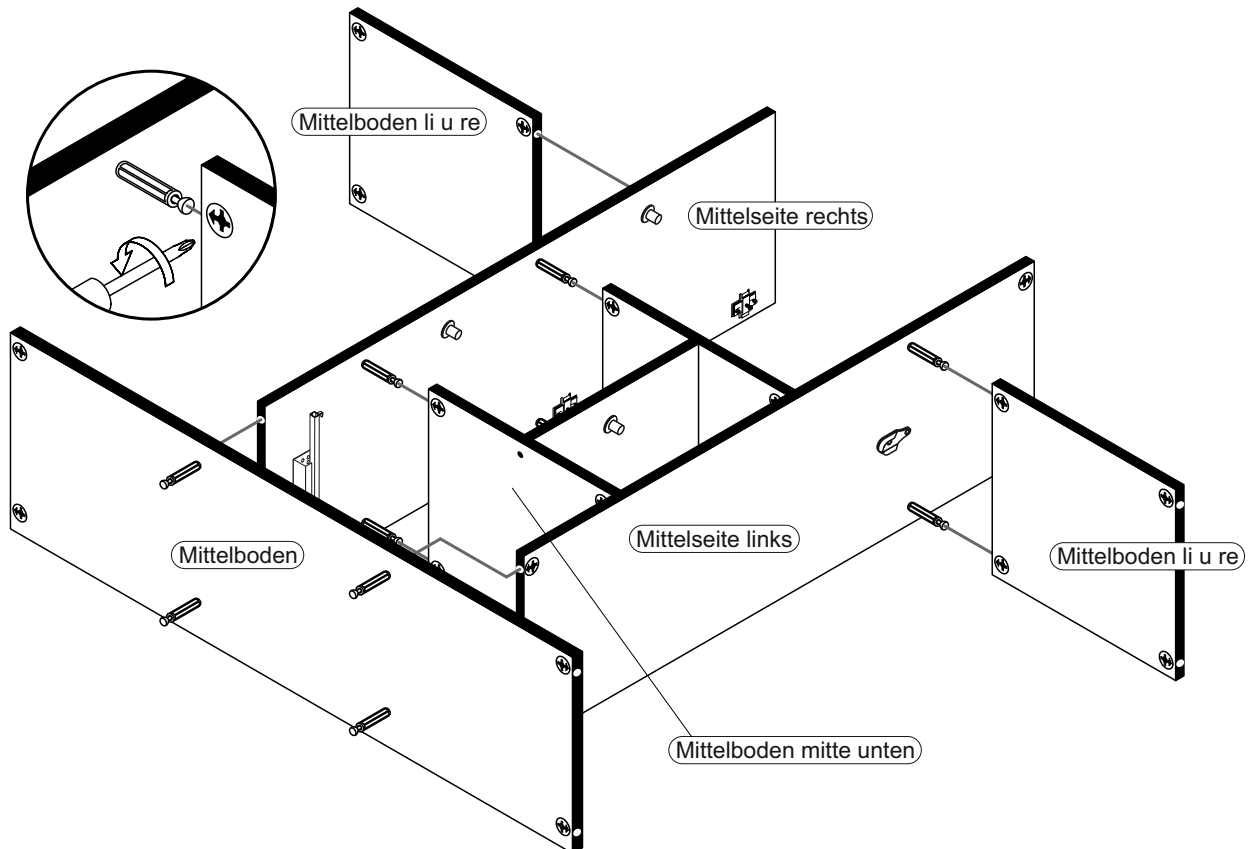

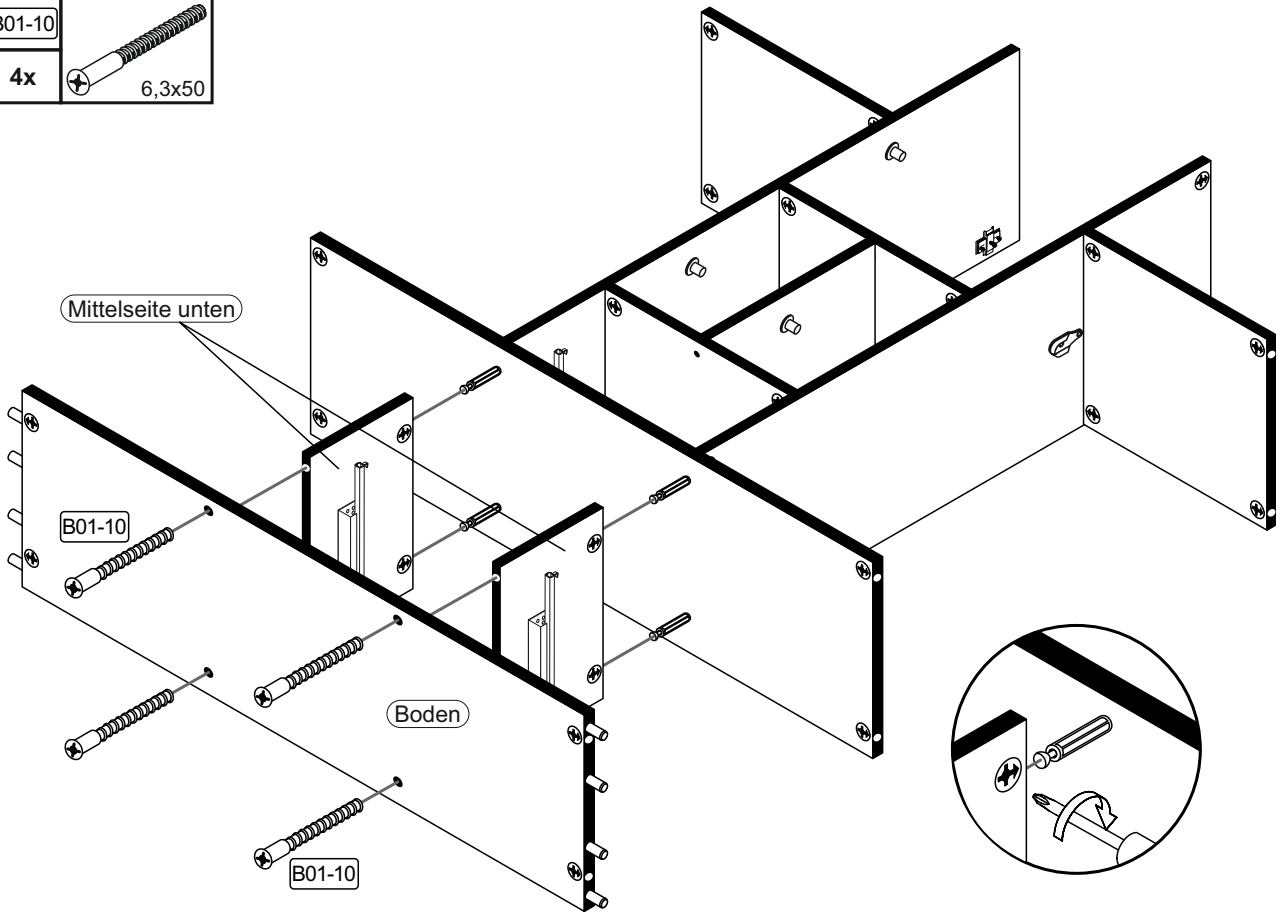

22

B01-10	
4x	6,3x50

23

B05-130	
1x	LEIM

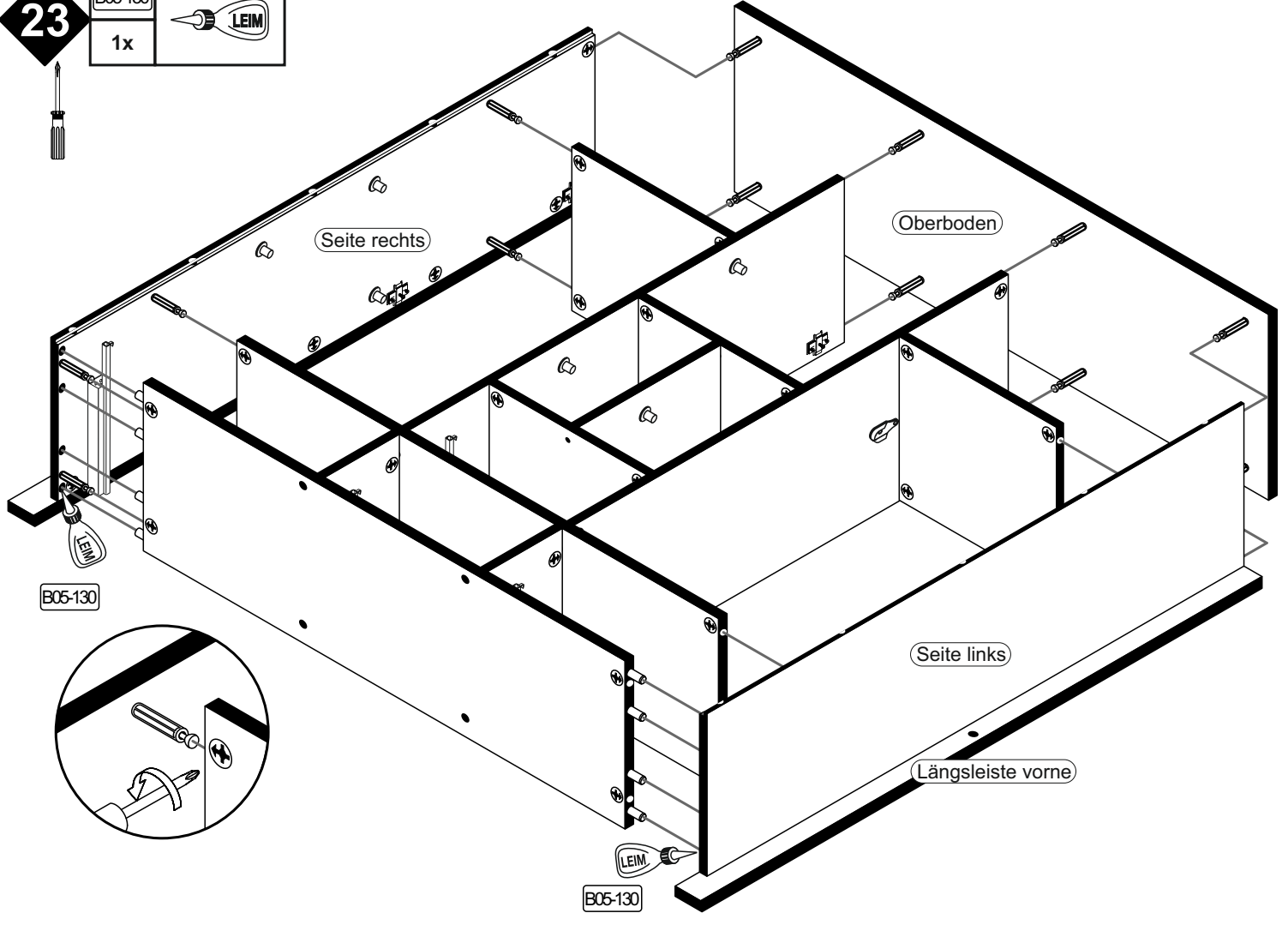

26

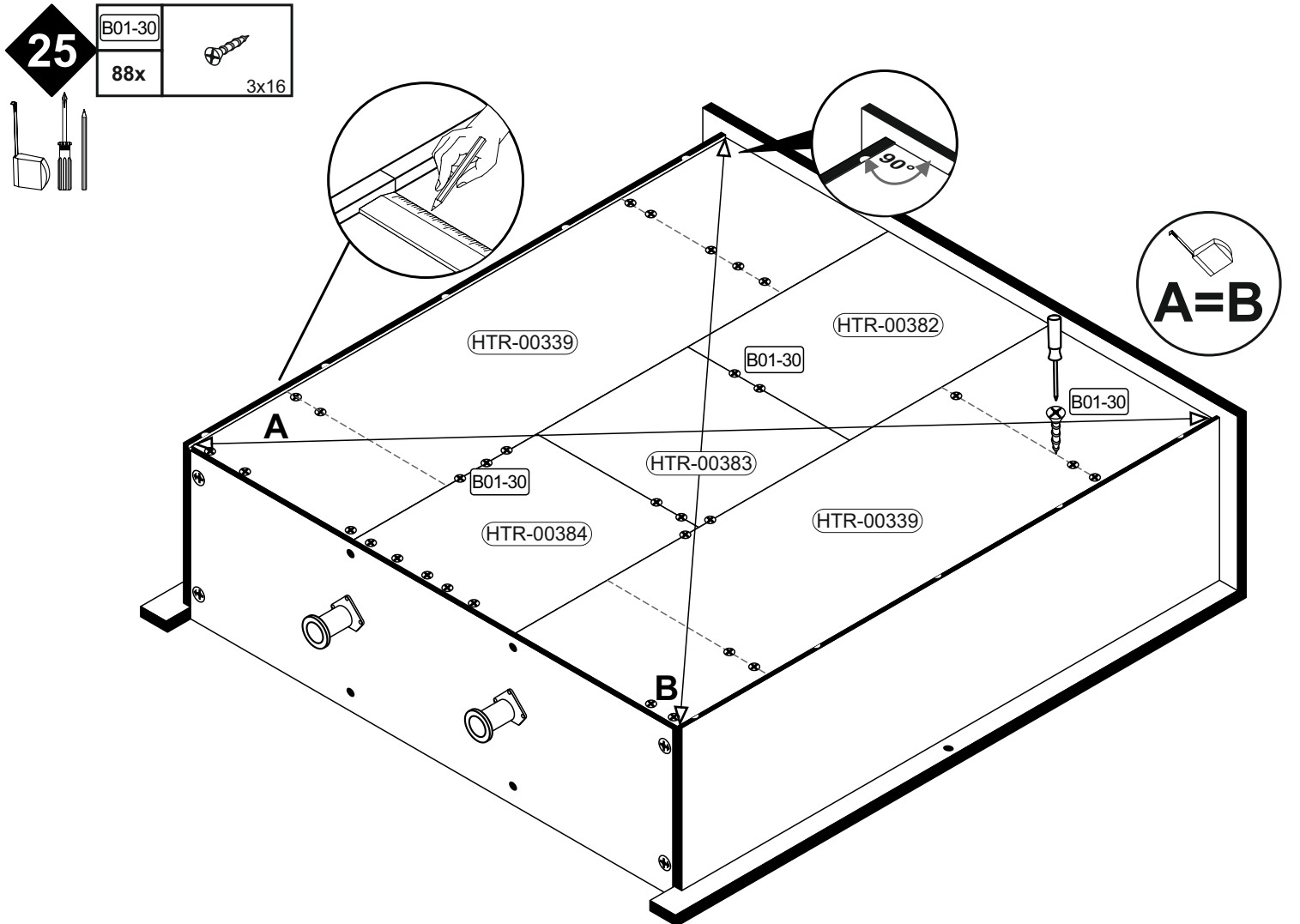
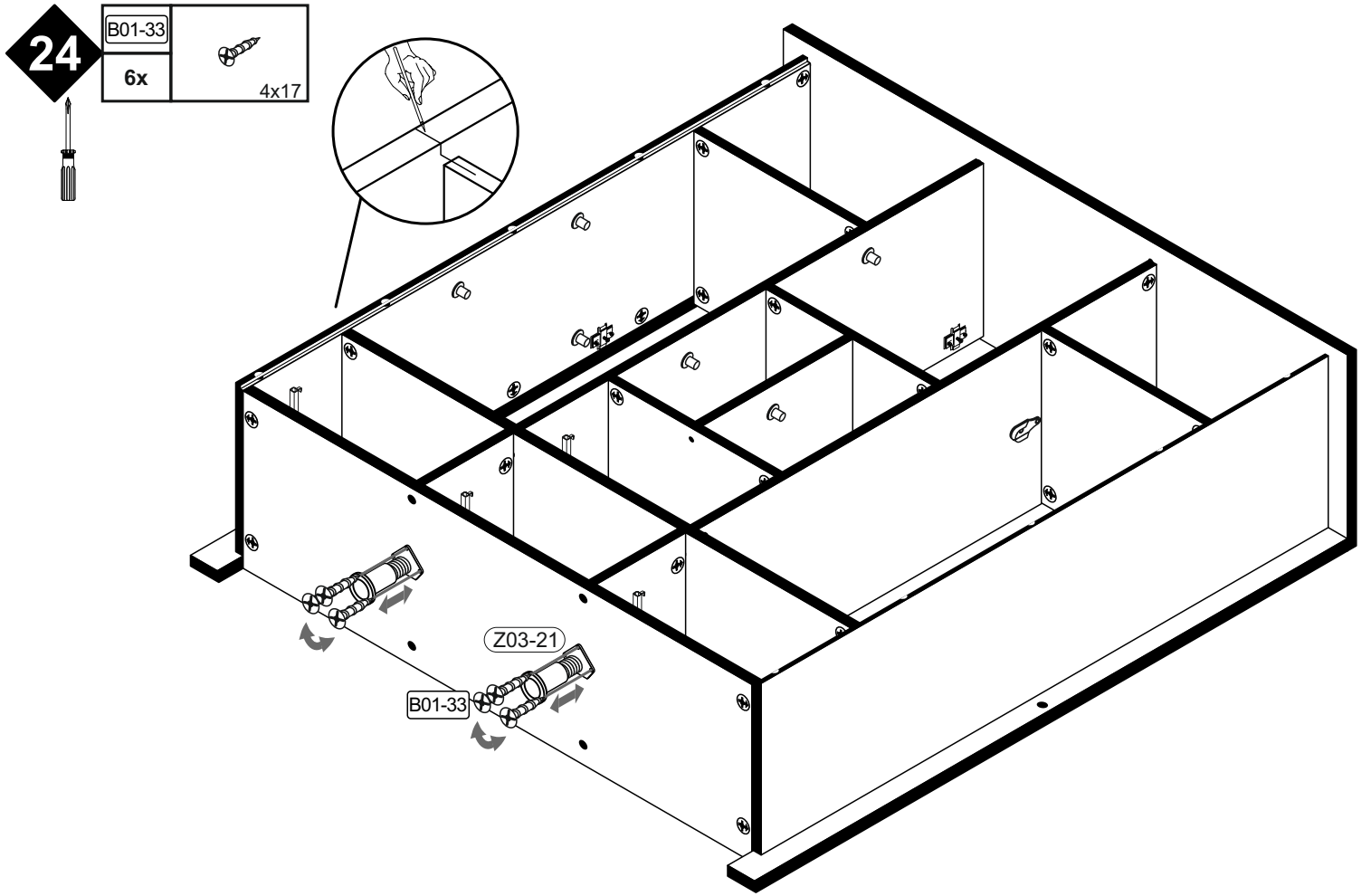
B01-10	
10x	6,3x50

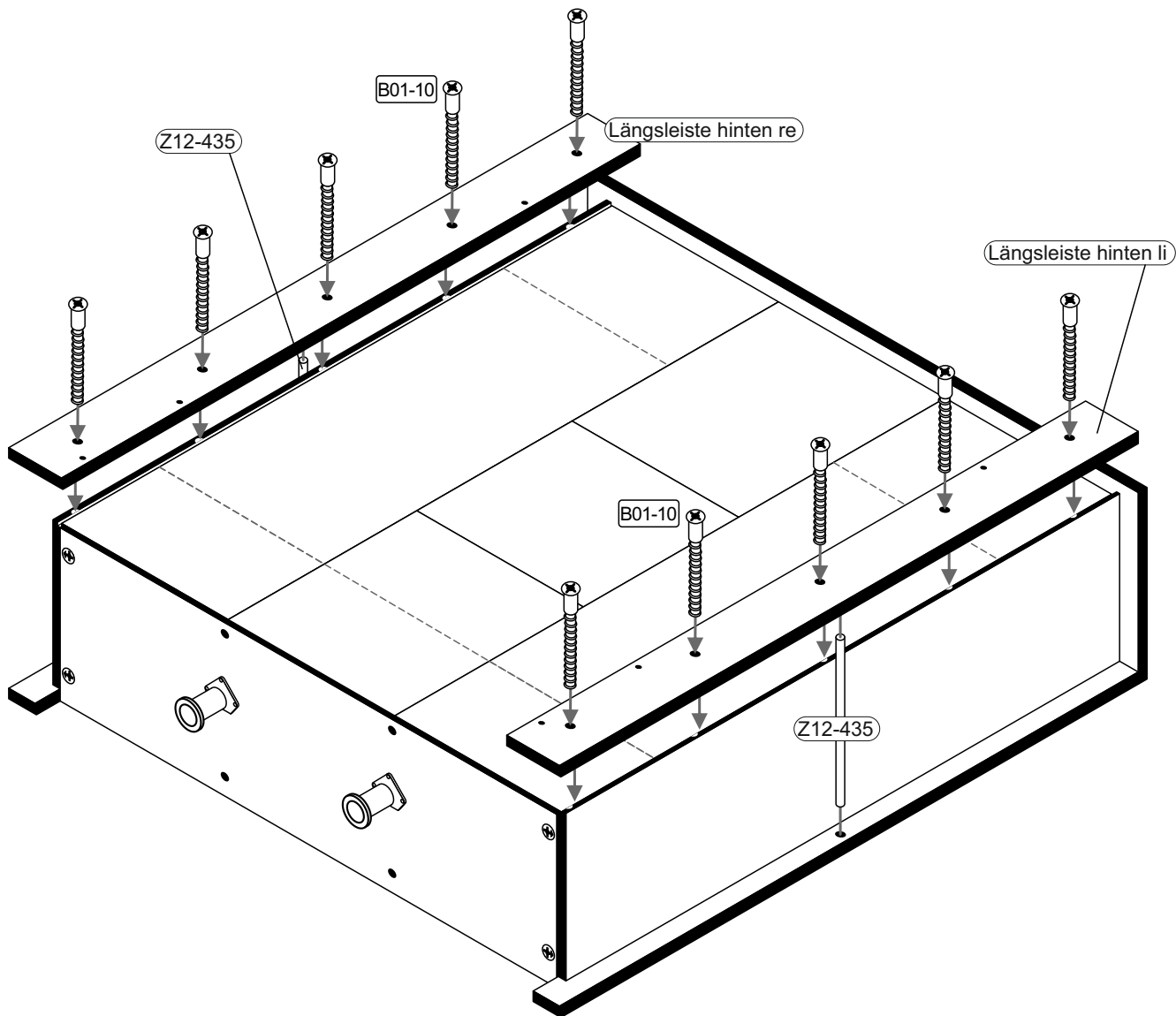

27

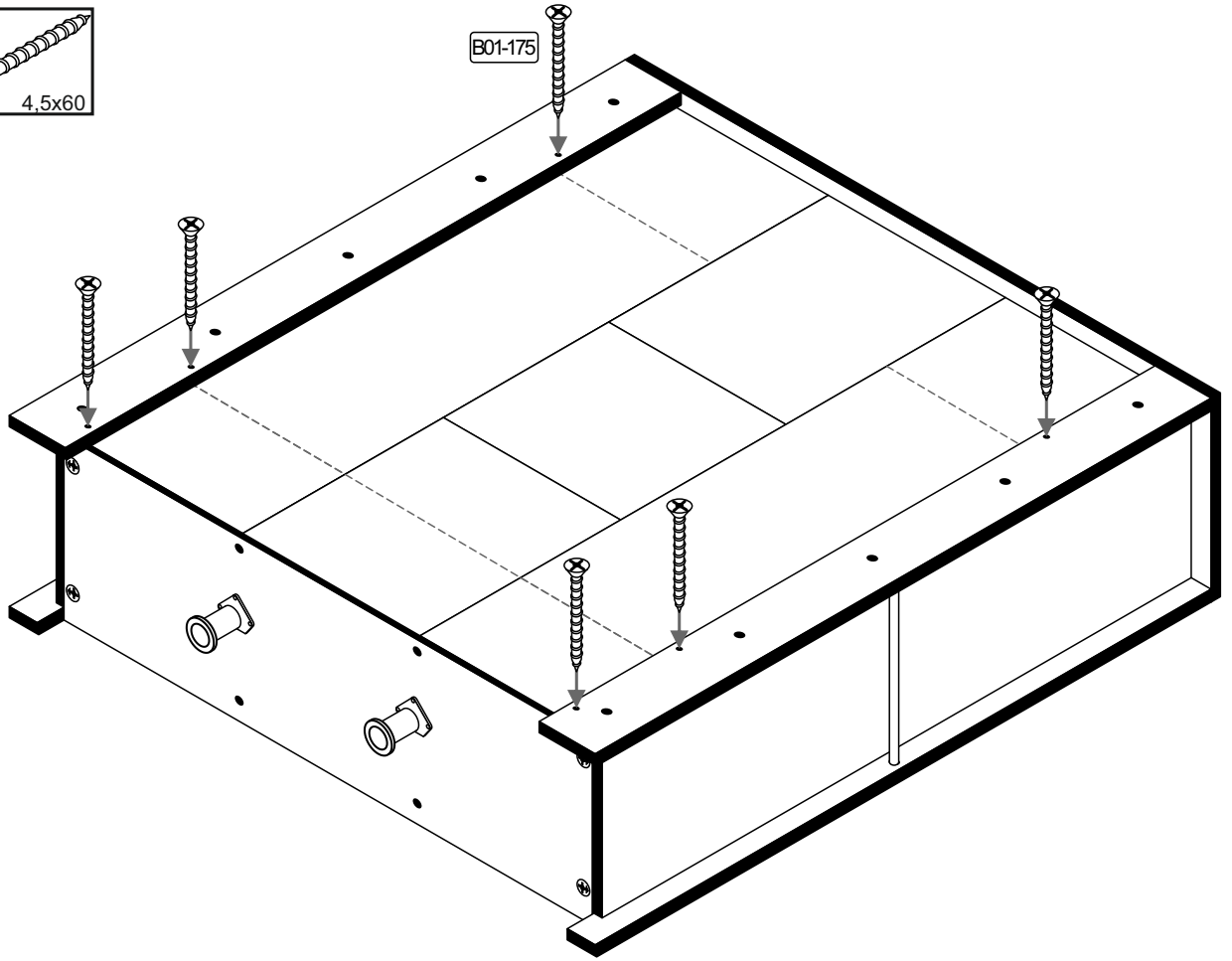
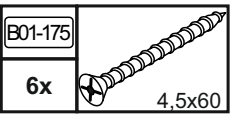

28

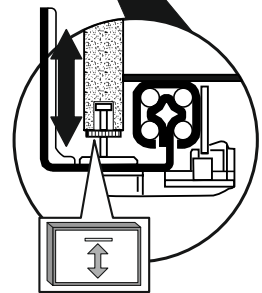
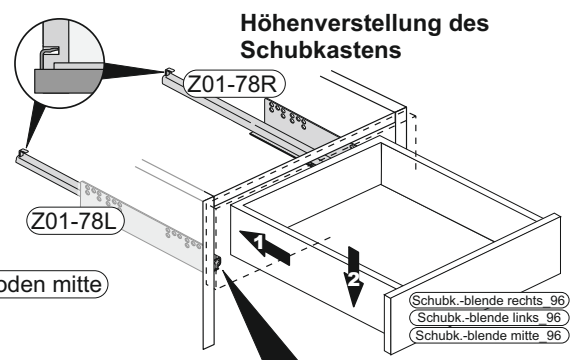
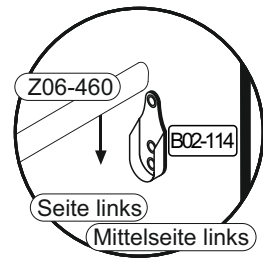
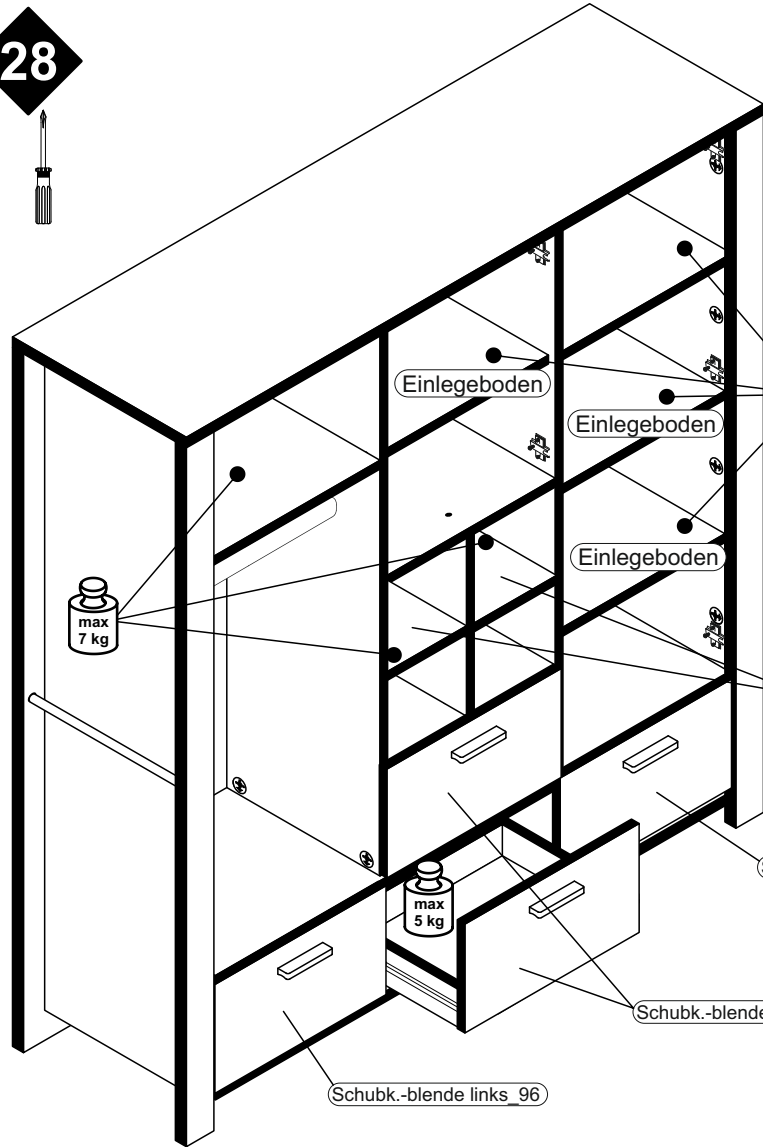



▶ SCAN ME

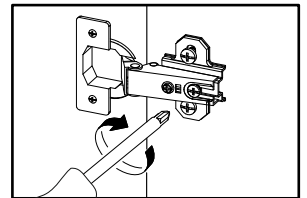
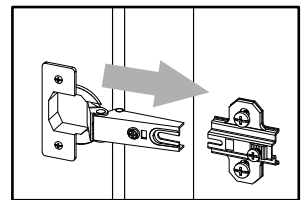
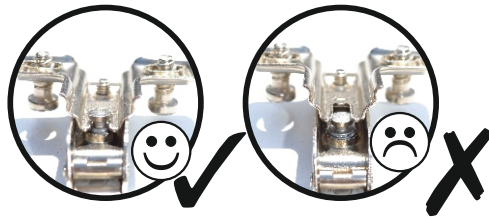
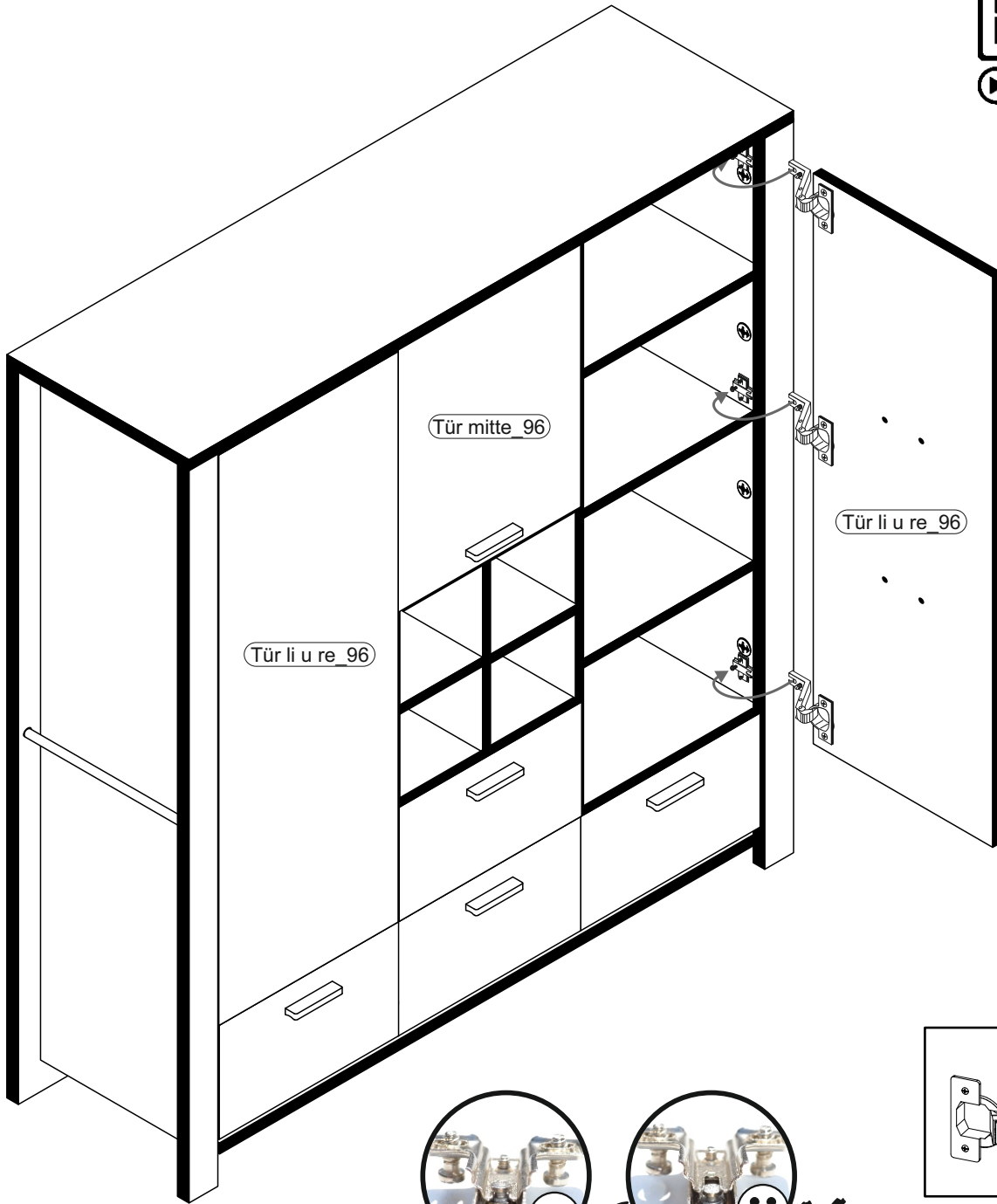

Türen einstellen (Scharniere justieren)

Adjusting the doors (adjusting the hinges)

Régler les portes (ajuster les charnières)

Sistemare le porte (regolare le cerniere)

Deuren instellen (scharnieren afstellen)

Nastawić drzwi (wyregulować zawiasy)

Vyrovnejte dvířka (seřid'te závěsy)

Nastavenie dverí (nastavenie závesov)

Állítsa be az ajtókat (állítsa be a zsanérokot)

Reglare uși (ajustare balamale)

Kapıların ayarlanması (menteşelerin seviye ayarı)

Регулировка дверей (регулировка шарнира)

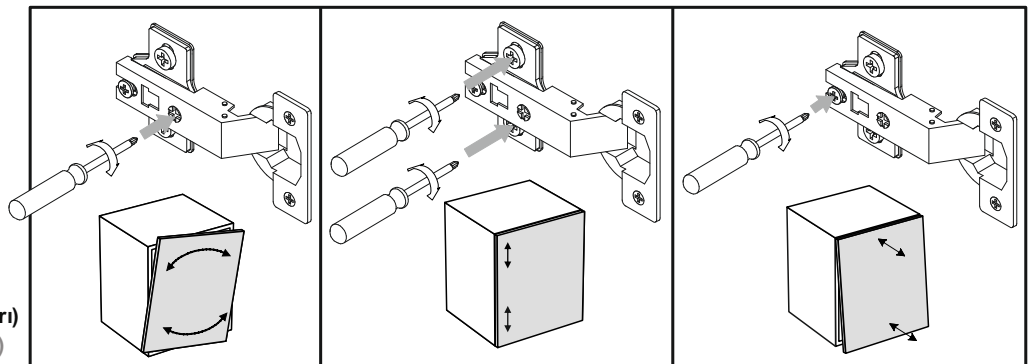

30



B01-37		B01-329		B03-07		B06-440	
1x	4,5x25	4x	M4x22	3x		2x	

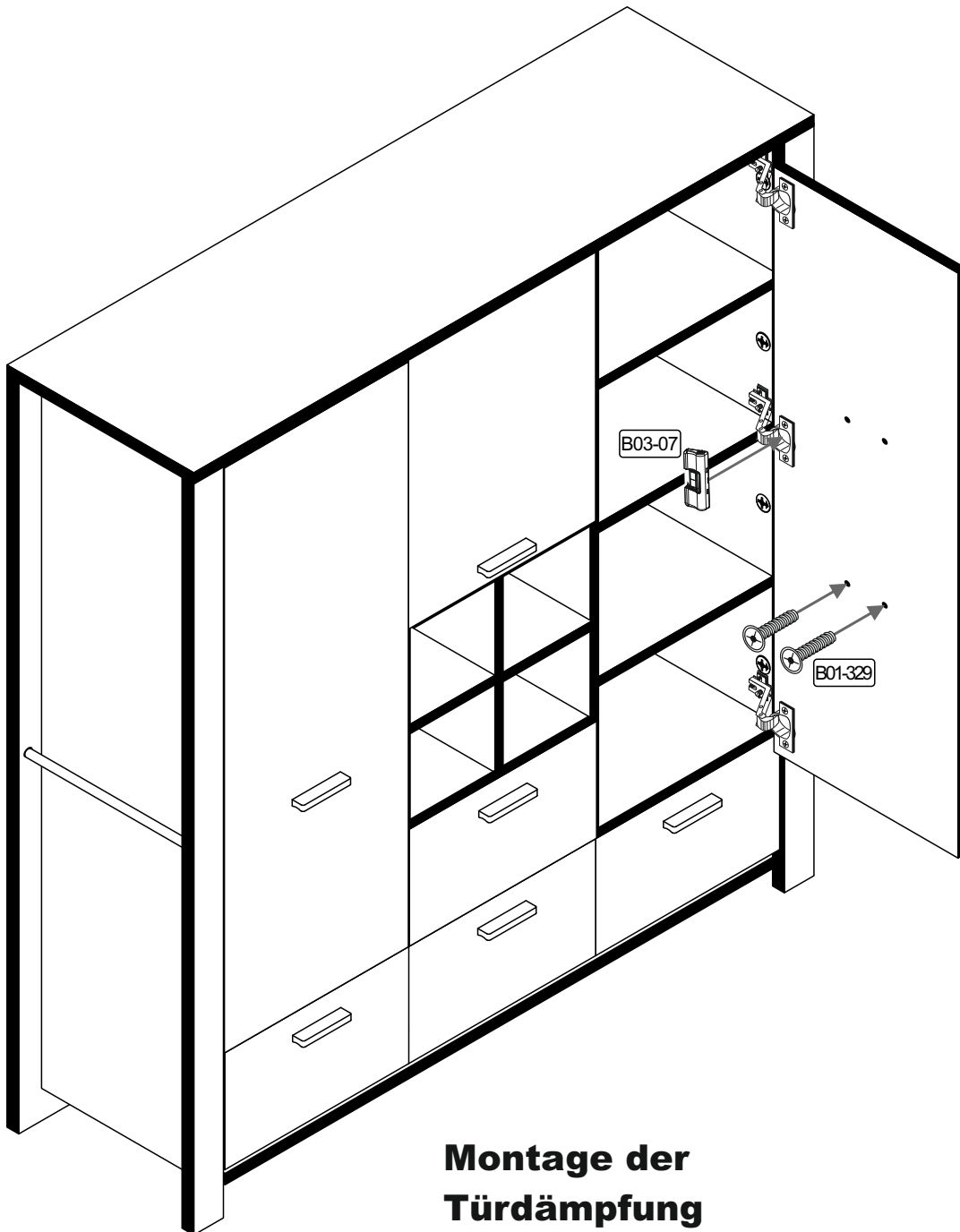

▶ SCAN ME

1.

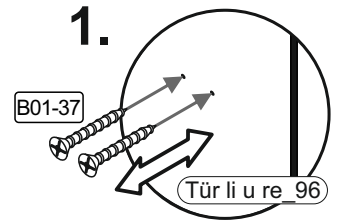

2.

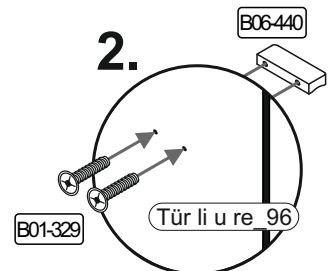

Montage der Türdämpfung

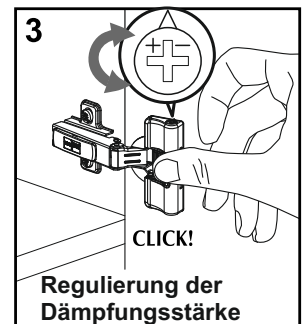
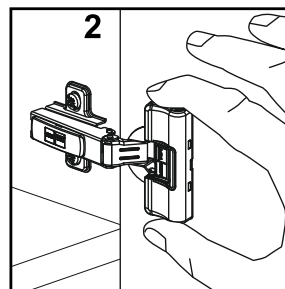
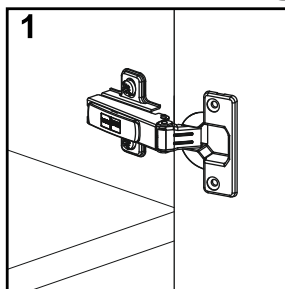

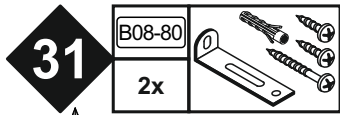

▶ SCAN ME

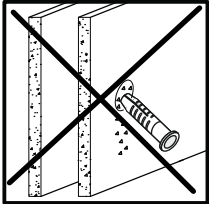
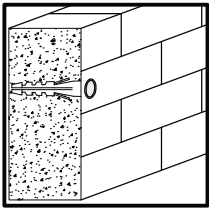
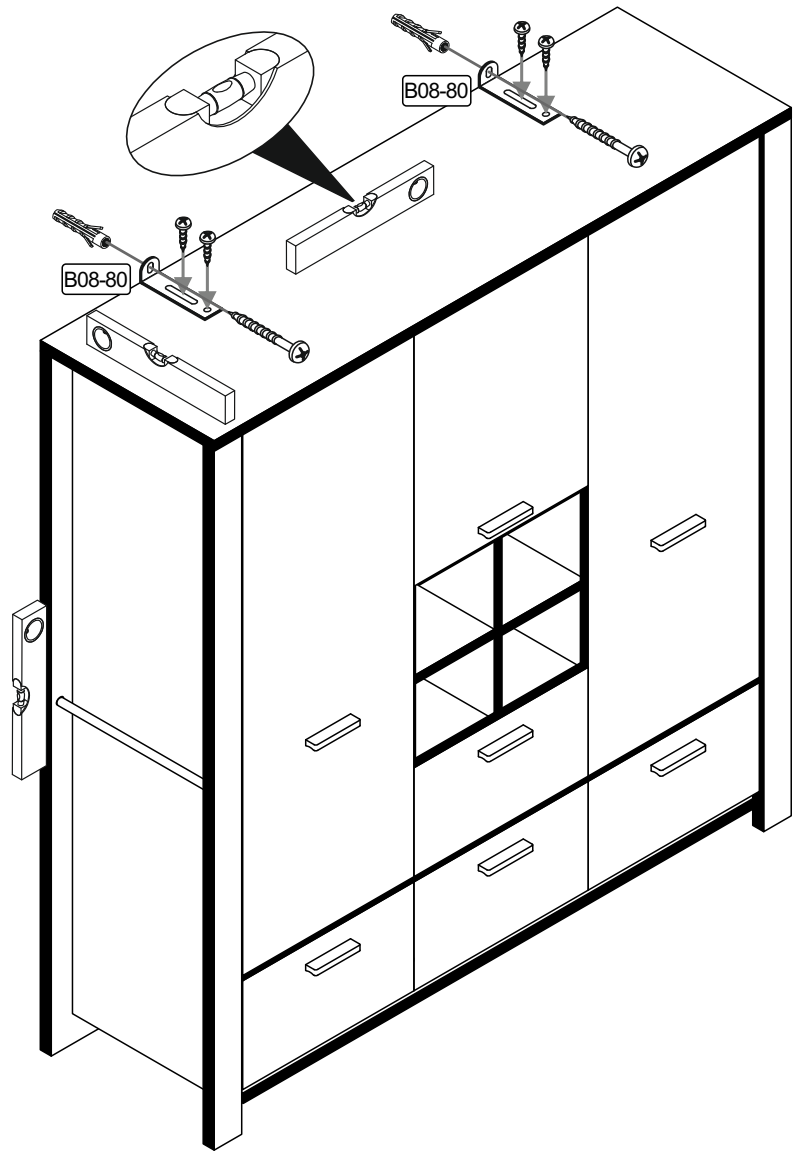

Achtung • Attention • Attenzione • Opgelet • Uwaga • Pozor • Figyelem • Atenție • Dikkat • Внимание	
(D)	Wandbefestigung dient als Kippschutz - unbedingt anbringen! Bei einigen Wandtypen kann ein Spezialdübel erforderlich sein!
(GB)	The wall fastening serves to prevent tipping - be absolutely sure to mount it! For certain wall types, a special wall plug may be necessary!
(FR)	La fixation murale sert de protection contre le basculement – à installer impérativement ! Pour certains types de murs il faut des chevilles spéciales !
(TR)	Duvardaki sabitleme, devrilmeye karşı bir emniyet tedbiridir ve mutlaka monte edilmelidir! Bazı duvar tiplerinde bunun için özel bir dübel gerekli olabilir!
(IT)	Il fissaggio alla parete serve da protezione anti-ribaltamento – attaccarla assolutamente! Per alcune strutture di parete può essere necessario un tassello speciale!
(NL)	Bevestiging aan de muur dient als kantelbescherming – zeker en vast bevestigen! Bij enkele muurtypes is een speciale plug misschien vereist!
(RU)	Обязательно установите крепление на стене во избежание опрокидывания! Для некоторых типов стен может потребоваться специальный дюбель!
(CZ)	Montáž na stěnu slouží jako ochrana proti převrnutí – bezpodmínečně umístěte! U některých typů stěn může být zapotřebí speciální hmoždinka!
(HU)	A terméket a falhoz kel rögzíteni, különben az felborulhat! Egyes faltípusoknál speciális tiplit kell használni!
(RO)	Sistemul de fixare la perete servește ca protecție la răsturnare - de montat obligatoriu! Pentru unele tipuri de pereți este posibil să fie necesar un diblu special!
(PL)	Mocowanie do ściany jest jednocześnie zabezpieczeniem przed przewróceniem – koniecznie zamontować! Do niektórych rodzajów ścian koniecznie zastosować specjalne kołki mocujące.
(SK)	Upevnenie na stenu slúži ako ochrana proti prevráteniu – bezpodmienečne použite! Pre niektoré druhy stien môže byť potrebná špeciálna hmoždinka!