

# G 093 / G 112

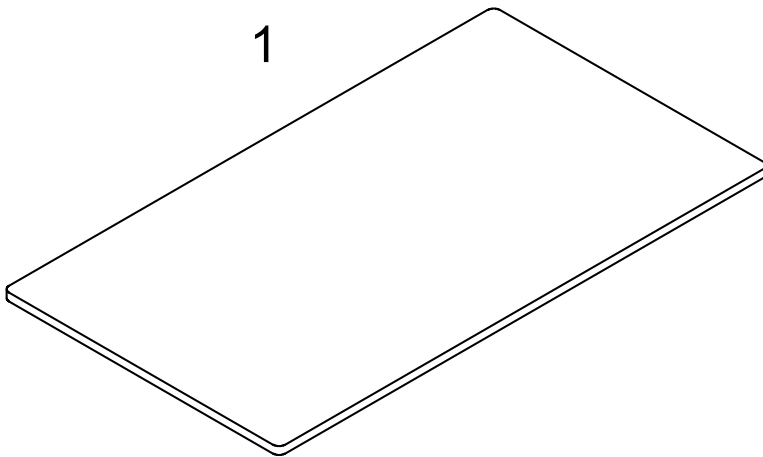

2.1

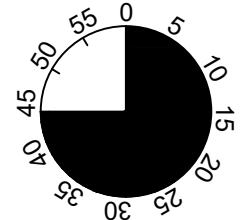

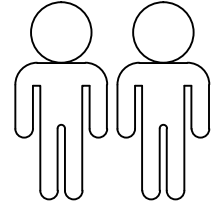
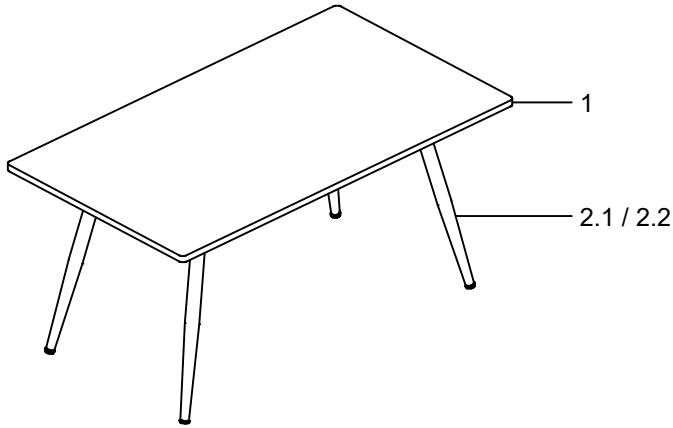
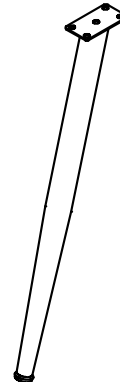

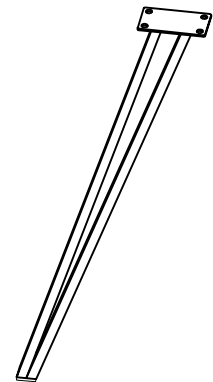



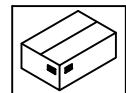
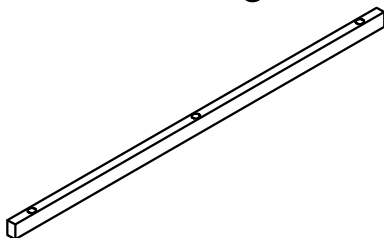



2.2

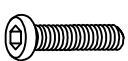

3







|         |    |     |
|---------|----|-----|
| 1       | 1X | 1/2 |
| 2.1/2.2 | 4X | 2/2 |
| 3       | 2X | 2/2 |

|   |  |   |  |   |   |   |  |   |   |   |   |
|---|--|---|--|---|---|---|--|---|---|---|---|
| A |  M6x12<br>6x      | B |  M8x12<br>16x | C |  M6x35<br>6x | D |  M8x16<br>16x | E |  Ø18xØ8x1.5<br>16x | F |  Ø25<br>(2.2) 4x |
| G |  Ø18xØ6x2.5<br>2x | H |  5MM<br>1x    | I |  6MM<br>1x   | J |  8MM<br>1x    |   |   |   |   |

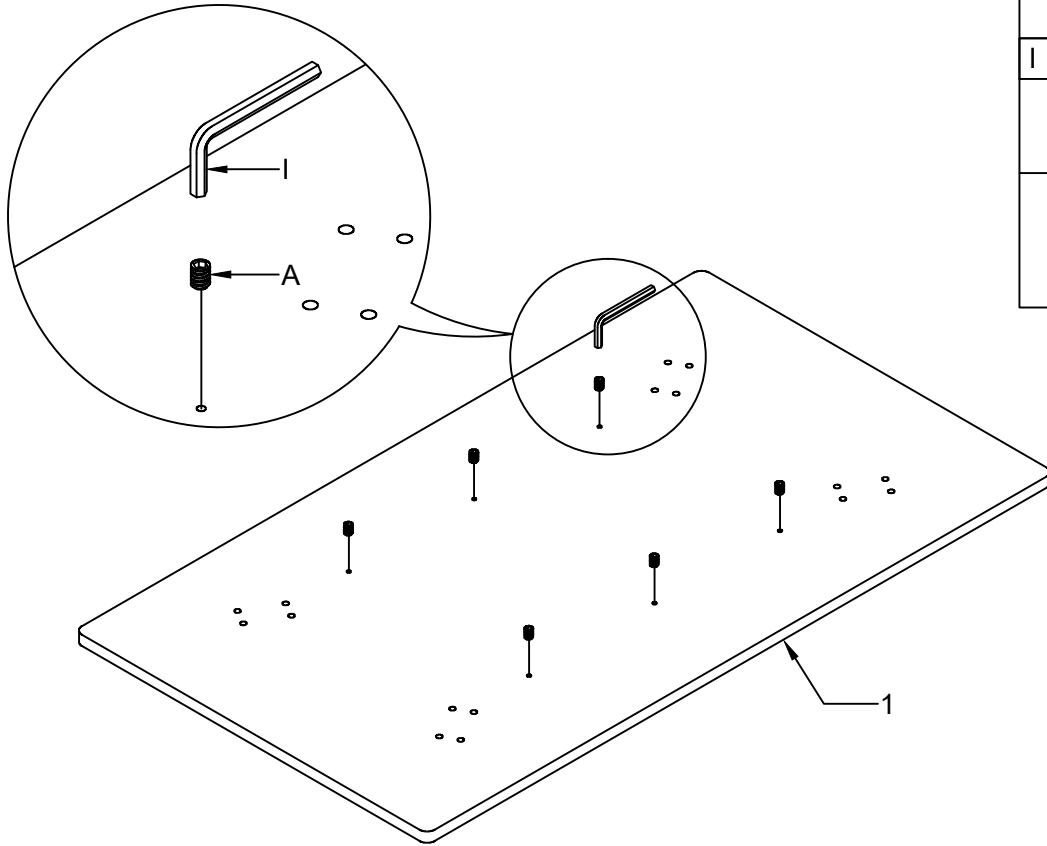
I.





1.

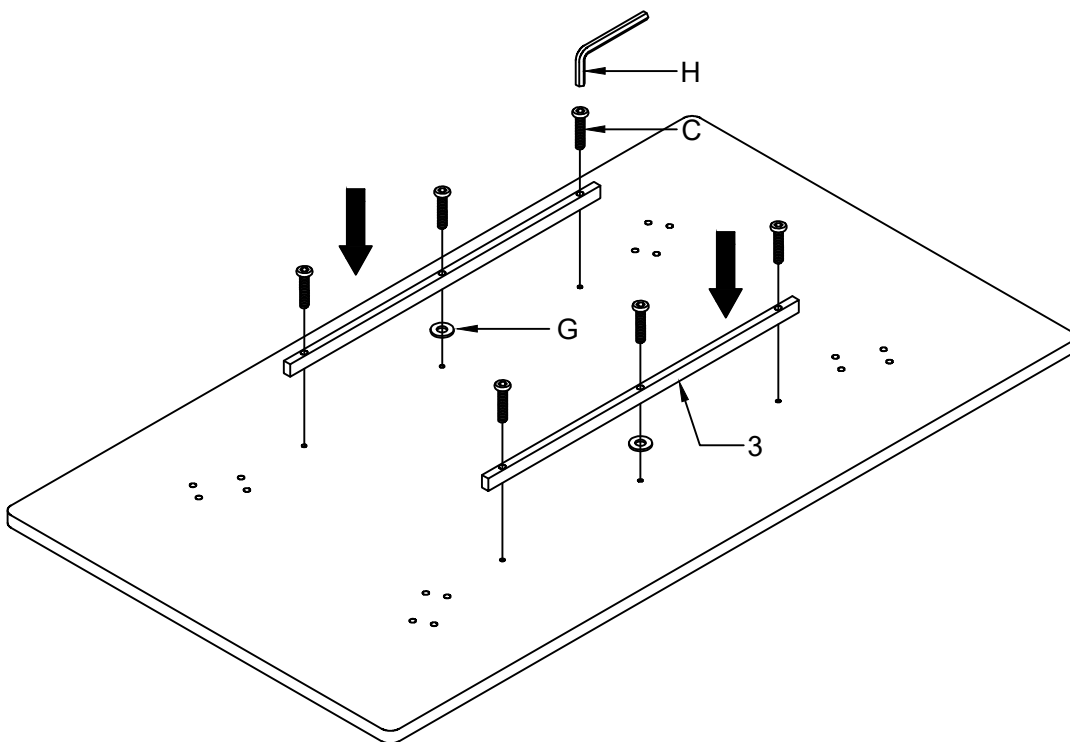

|   |       |
|---|-------|
| A   | M6x12 |
|  | 6x    |
| I   | 6MM   |
|  | 1x    |
|  |       |

2.





|   |            |   |       |
|---|------------|---|-------|
| G   | Ø18xØ6x2.5 | C   | M6x35 |
|  | 2x         |  | 6x    |
|   |            | H   | 5MM   |
|   |            |  | 1x    |
|  |            |   |       |

II.

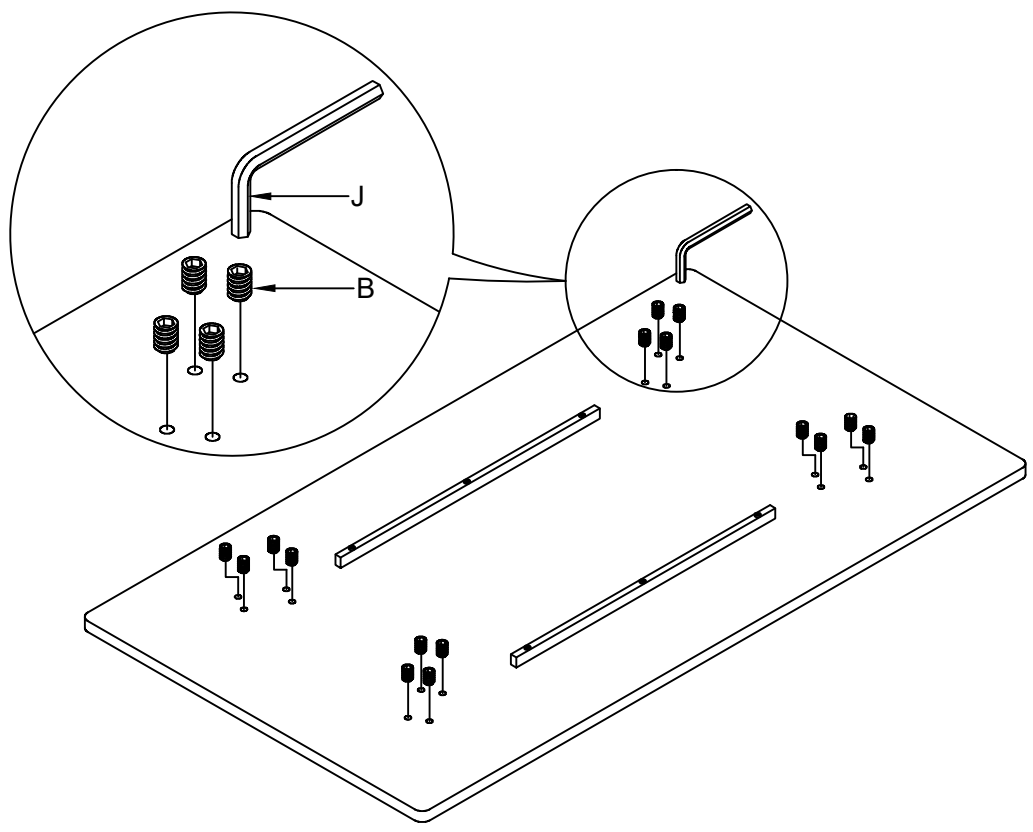

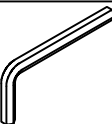

3.

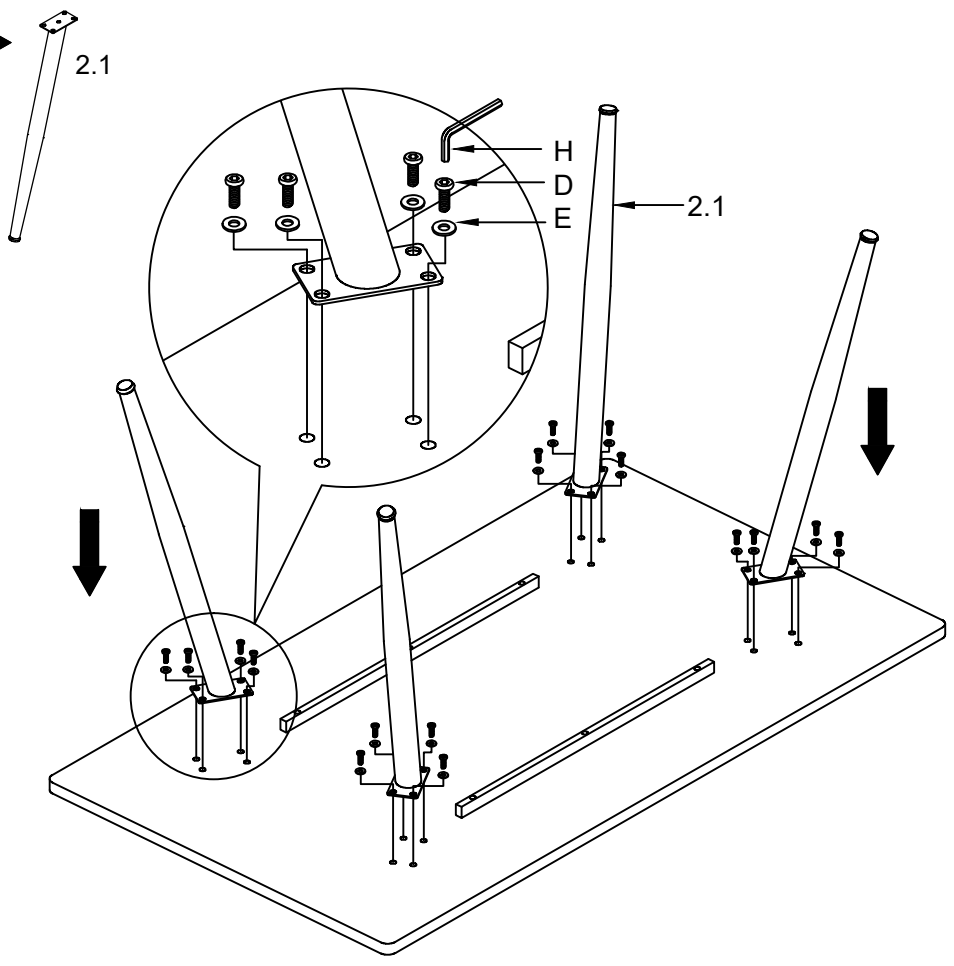

|   |       |
|---|-------|
| B   | M8x12 |
|  | 16x   |
| J   | 8MM   |
|  | 1x    |
|  |       |

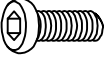
4.1 →



|   |            |
|---|------------|
| D   | M8x16      |
|  | 16x        |
| E   | Ø18xØ8x1.5 |
|  | 16x        |
| H   | 5MM        |
|  | 1x         |
|  |            |

