

BENTE

Polsterecke links

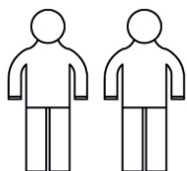

20 min



- | | |
|----------------------------------|------------------------------|
| (D) Montageanleitung | (GB) Assembly instructions |
| (FR) Notice de montage | (IT) Istruzioni di montaggio |
| (NL) Handleiding voor de montage | (PL) Instrukcja montażu |
| (CZ) Montážní návod | (SK) Návod na montáž |
| (HU) Szerelési útmutató | (RO) Instrucțiuni de montaj |
| (TR) Montaj talimatı | (RU) Инструкция по монтажу |

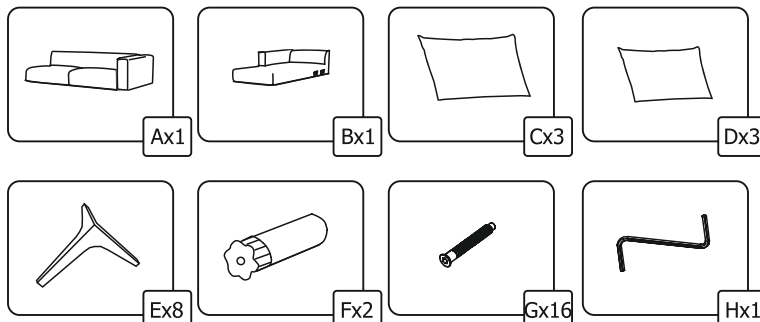
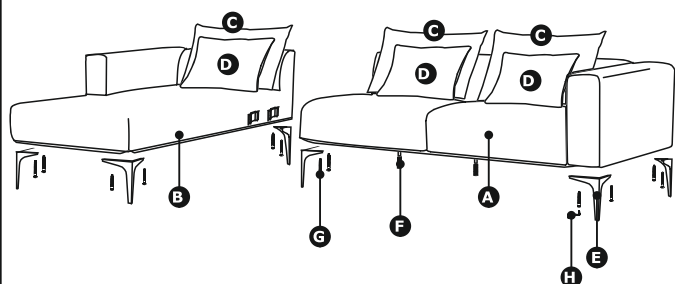

1

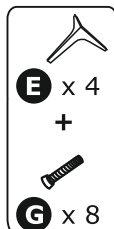
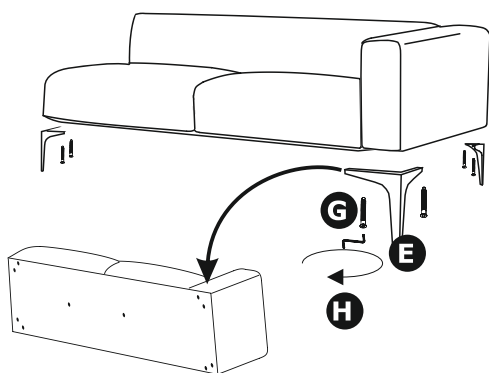

2

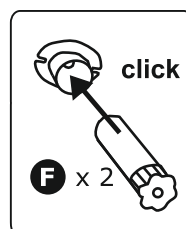
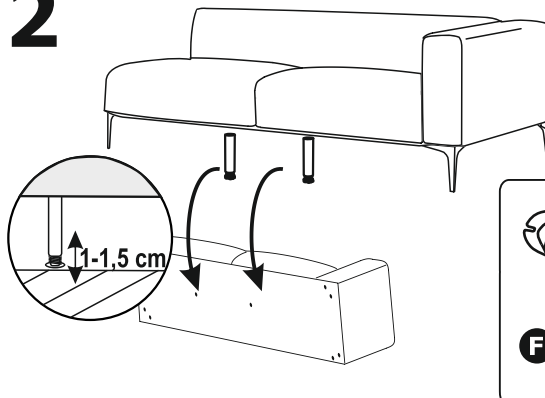

3

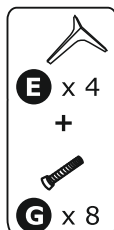
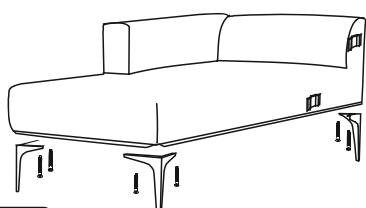

4

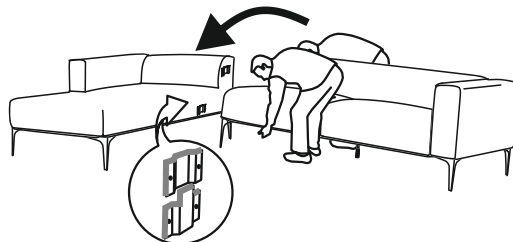

5

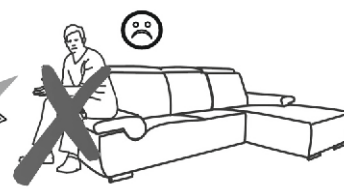
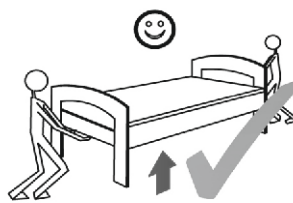
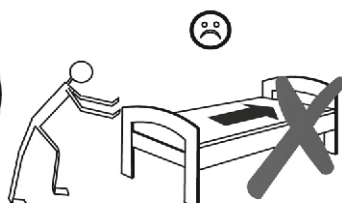
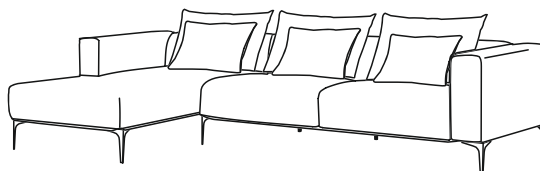

Service • Assistenza • Dienstverlening • Serwis Servis • Szerviz • Сервисная служба

Name • Nom • Nome • Naam • Nazwa • Jméno • Názov • Név • Denumire • Isim • Название	BENTE
Nr. • No. • N° • Номер • Č • Sz	
Typ • Type • Tip • Típus • Tipo • Тип	POLSTER ECKE L

