

(D) Montageanleitung

(GB) Assembly instructions

(RO) Instrucțiuni de montaj

(FR) Notice de montage

(IT) Istruzioni di montaggio

(RU) Инструкция по монтажу

(NL) Handleiding voor de montage

(HU) Szerelési útmutató

(PL) Instrukcja montażu

(CZ) Montážní návod

(TR) Montaj talimatı

(SK) Návod na montáž



10

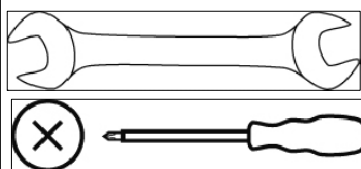

13

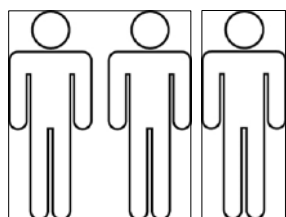

29.09.2011

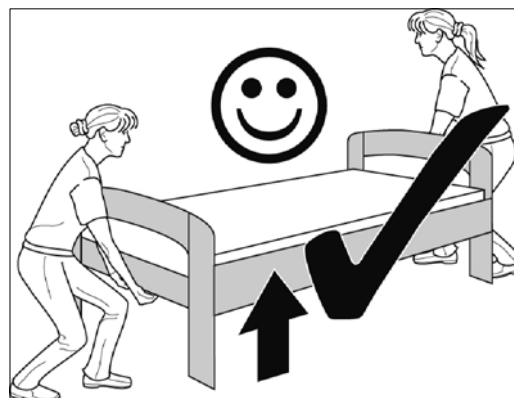

SK LAGO LR ZER EB

# Service • Assistenza • Dienstverlening • Serwis Servis • Szerviz • Сервисная служба

Name • Nom • Nome • Naam  
Nazwa • Jméno • Názov • Név  
Denimire • Ísim • Название

SKLR-  
ZER-EB

Nr. • No. • N° • Номер • Č • Sz

Тур • Туре • Тір • Тірус • Тіро  
Тип

- 0 -

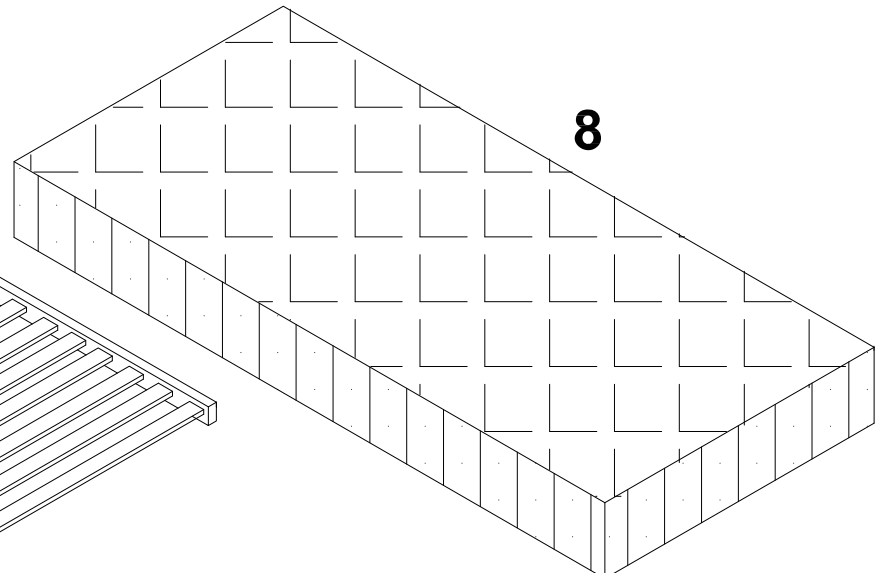
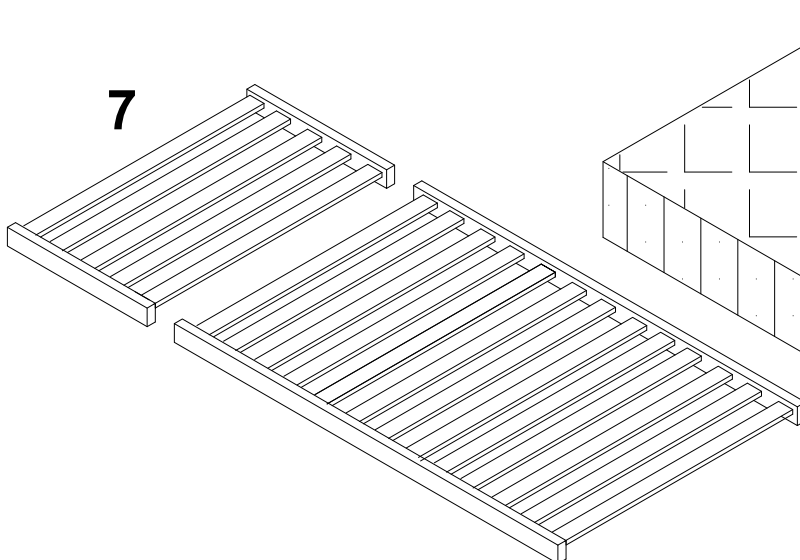
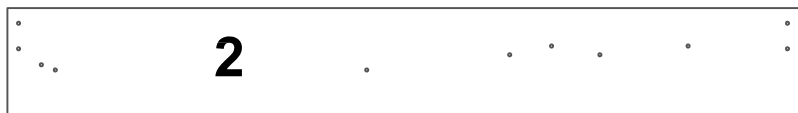
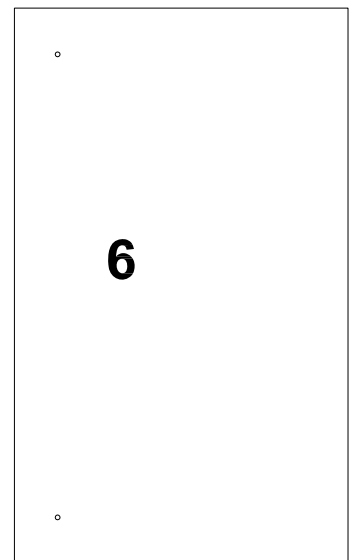
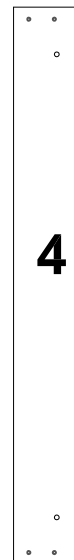
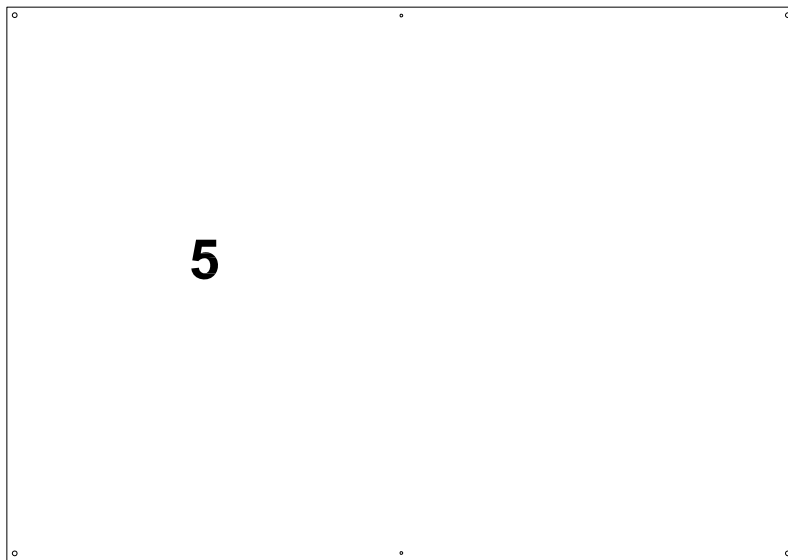
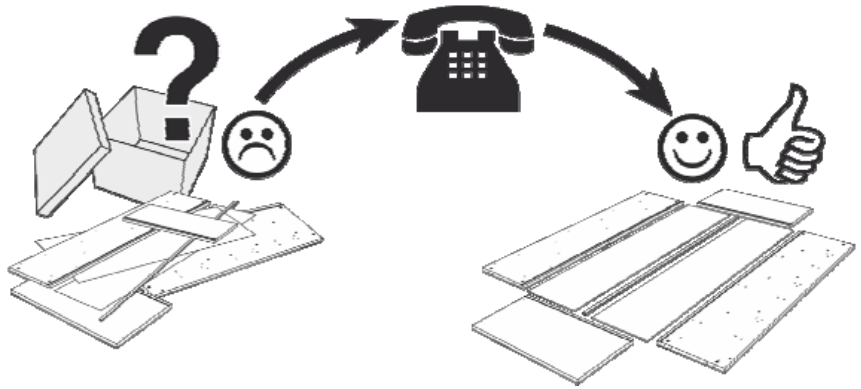
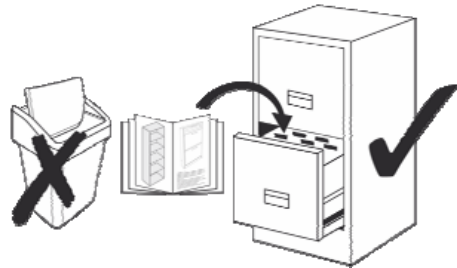

# Service • Assistenza • Dienstverlening • Serwis Servis • Szerviz • Сервисная служба

Name • Nom • Nome • Naam Nazwa • Jméno • Názov • Név Denumire • Ísim • Название	SKLR- ZER-EB	
Nr. • No. • N° • Номер • Č • Sz		
Typ • Type • Tip • Típus • Tipo Тип	- 0 -	

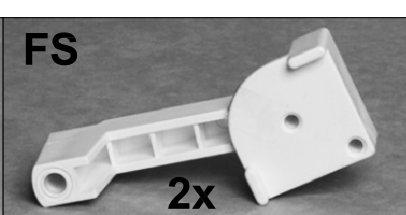
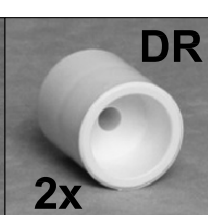
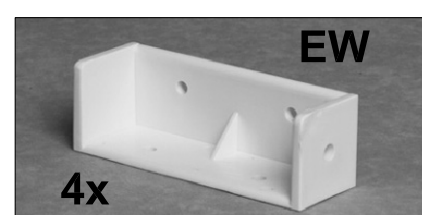
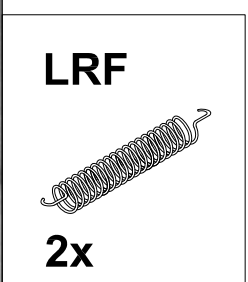
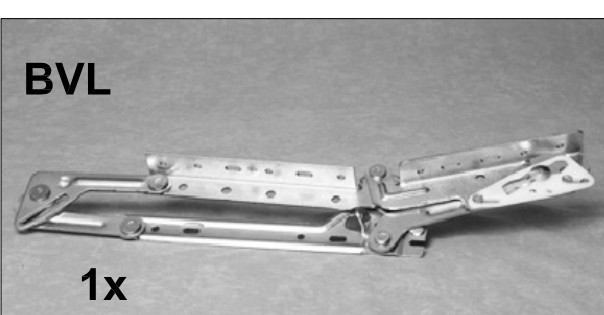
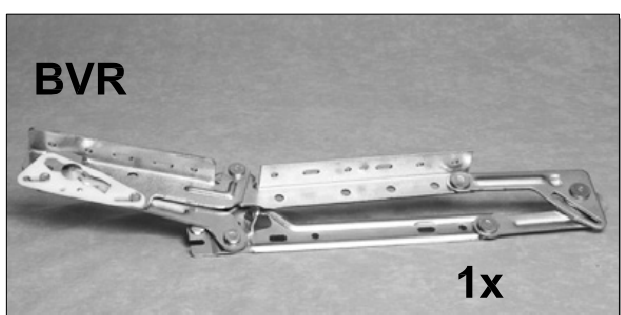
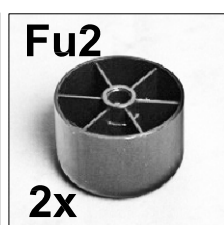
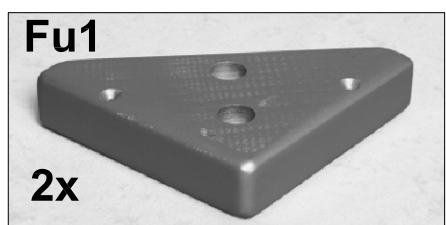

<b>A</b> x20	<b>B</b> x2	<b>C</b> x2	<b>D</b> x2	<b>E</b> x2	<b>F</b> 2/x2	<b>G</b> x2	<b>H</b> 3/x2	<b>J</b> x2	<b>K</b> 2/x2	<b>J</b> x2	
<b>M6x20</b>	<b>M6x35</b>	<b>M6x45</b>	<b>4,5x45</b>	<b>M8x45</b>	<b>M8</b>	<b>M6x35</b>	<b>M6</b>	<b>M5x16</b>	<b>M5</b>	<b>4,5x16</b>	

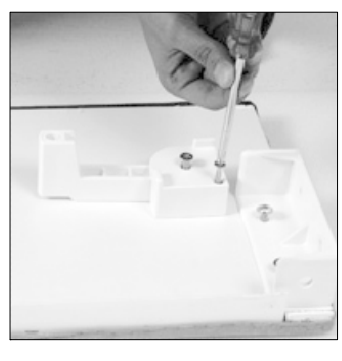
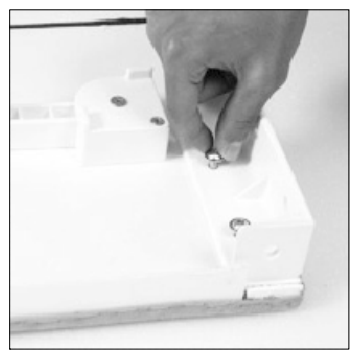
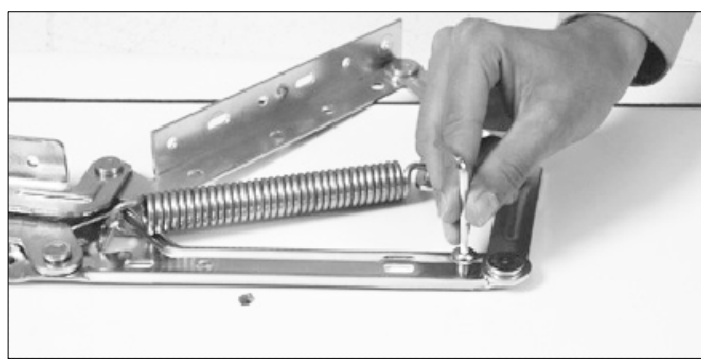
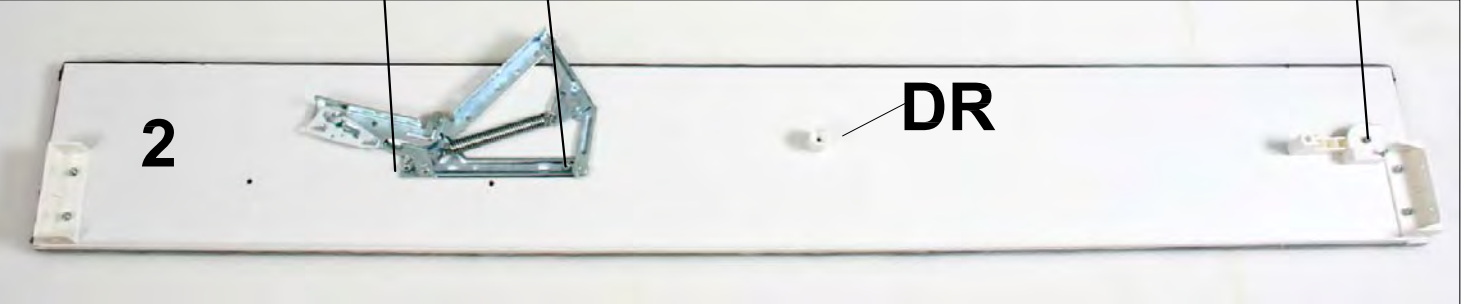
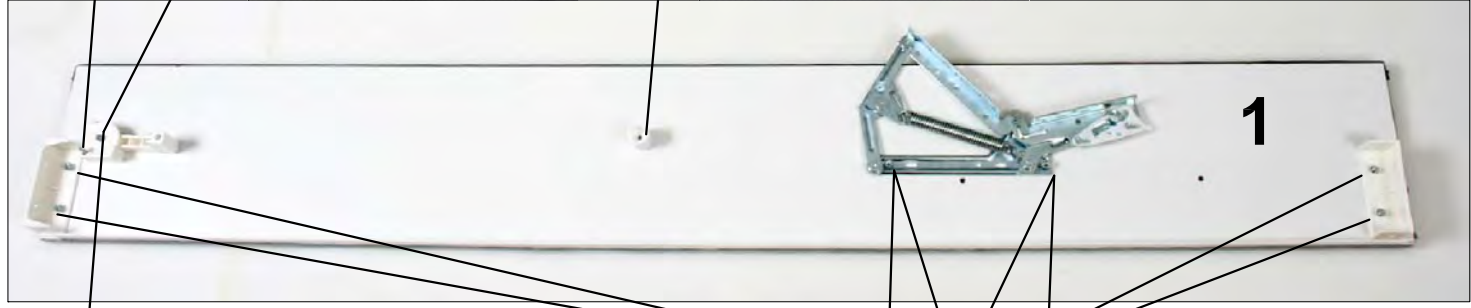
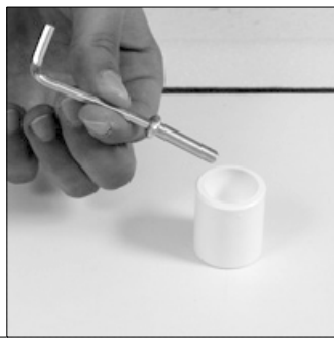
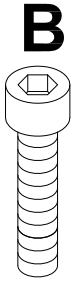
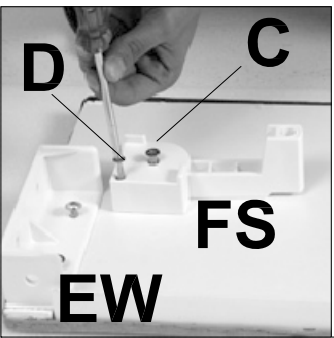
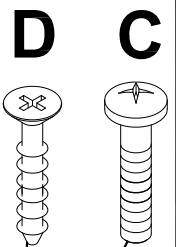



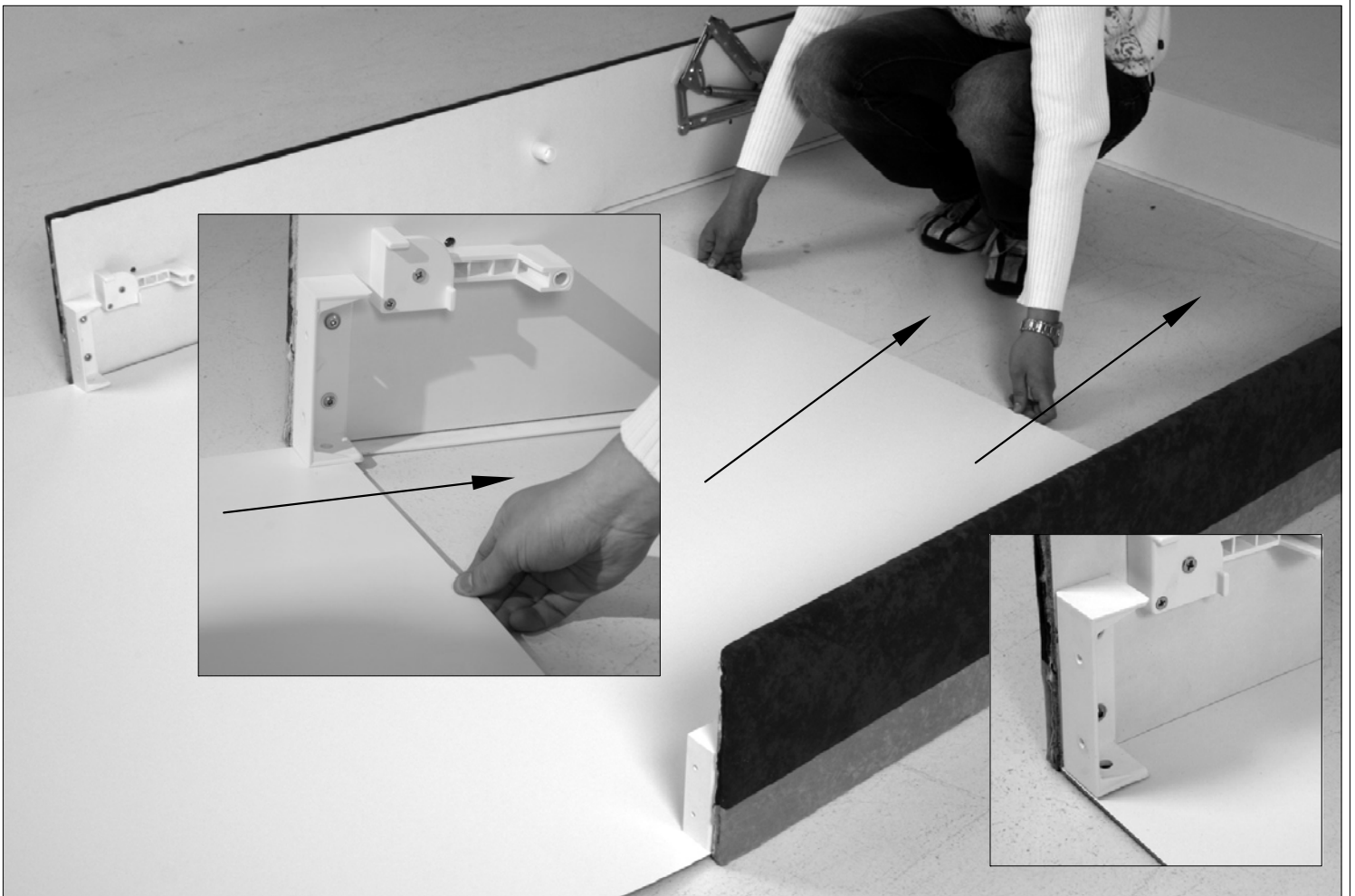
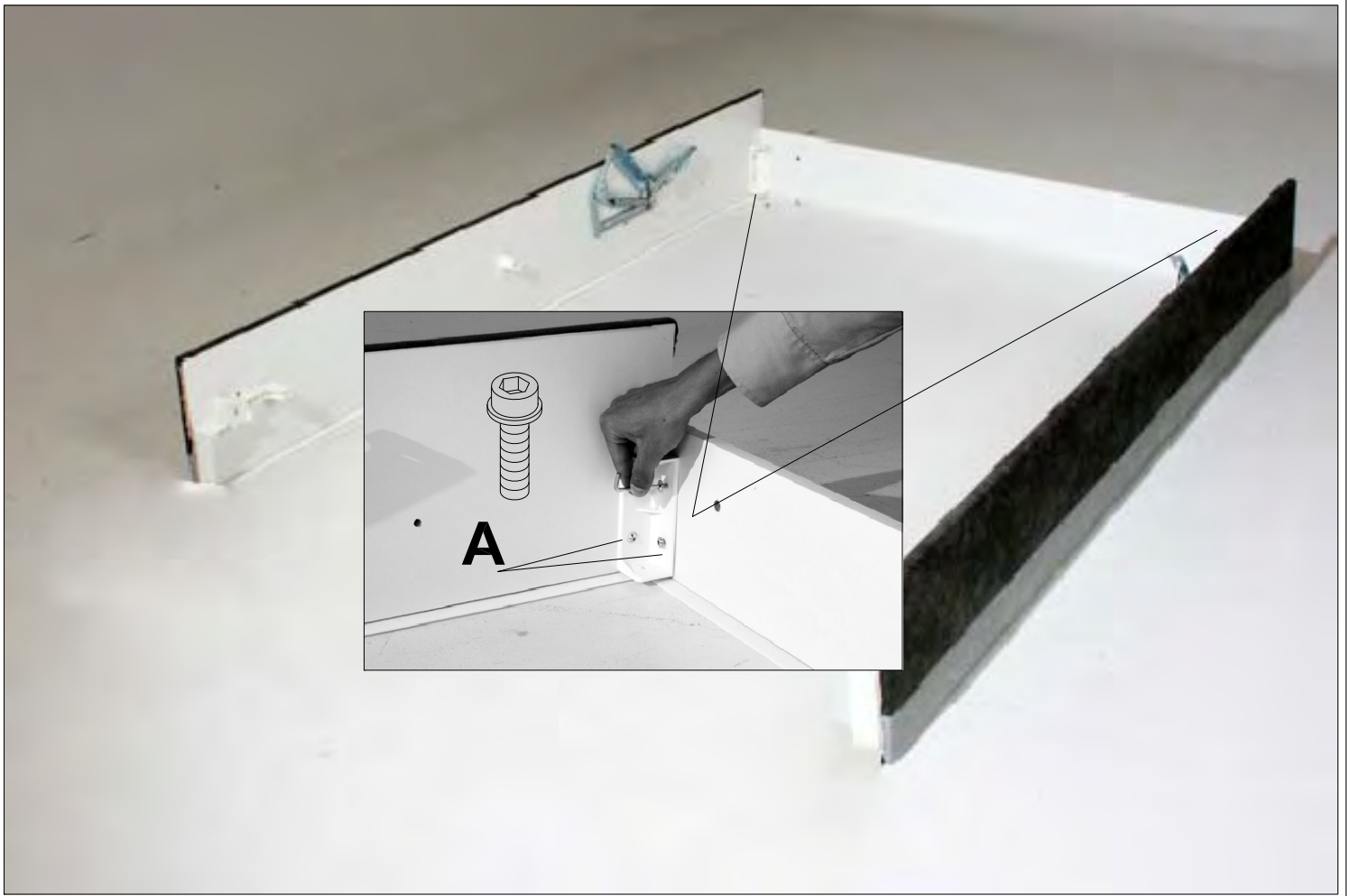

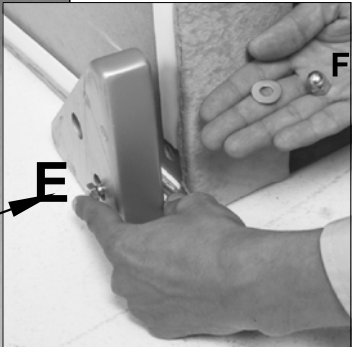
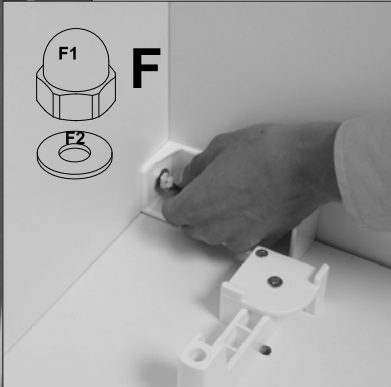
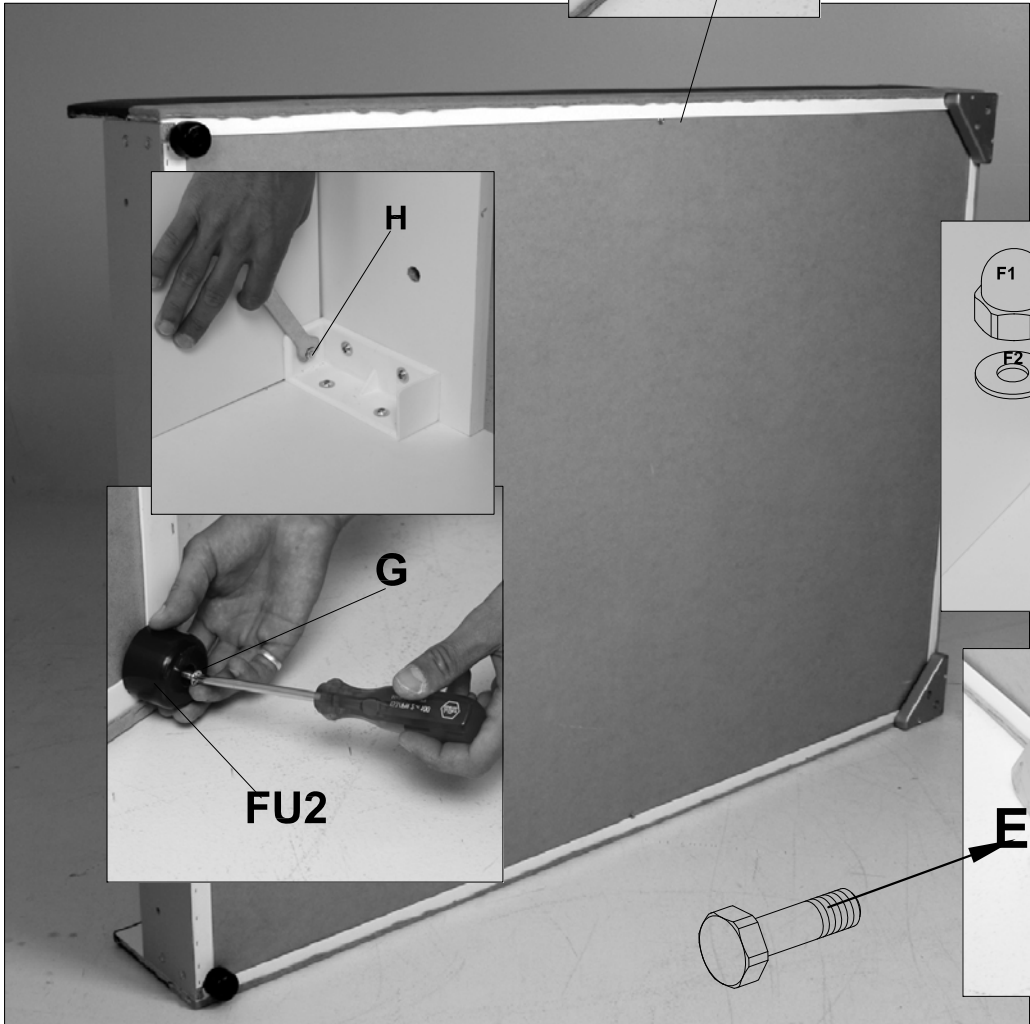
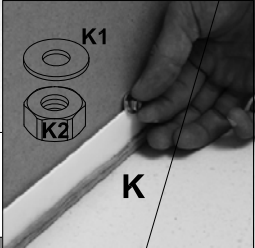



**D** Die Formen von Bauteilen können von dieser Zeichnung abweichen.

**GB** Shapes of individual parts may vary from drawing (foot end, headboard, etc.)

**PL** Kształty elementów łóżka mogą różnić się od tych przedstawionych na rysunku

**TR** Yapı parçalarının görünüşleri çizimde görünenden farklı olabilir.

**NL** De vormen van de individuele bouwelementen kunnen van de tekening afwijken.

**RU** Формы конструктивных элементов могут отличаться от этого рисунка

**I** Le forme possono variare a secondo del modello dal disegno sottostante

**F** La forme des éléments peut diverger de cette illustration (pied de lit, tête de lit, panneau arrière, etc.).

**HU** A bútor elemek formája eltérő lehet a rajzon szemantikusan ábrázolt mintától.

**CZ** Rozměry a profil zobrazených elementů se mohou od tohoto výkresu odlišovat

**RO** Forma componentelor poate să difere de această schiță

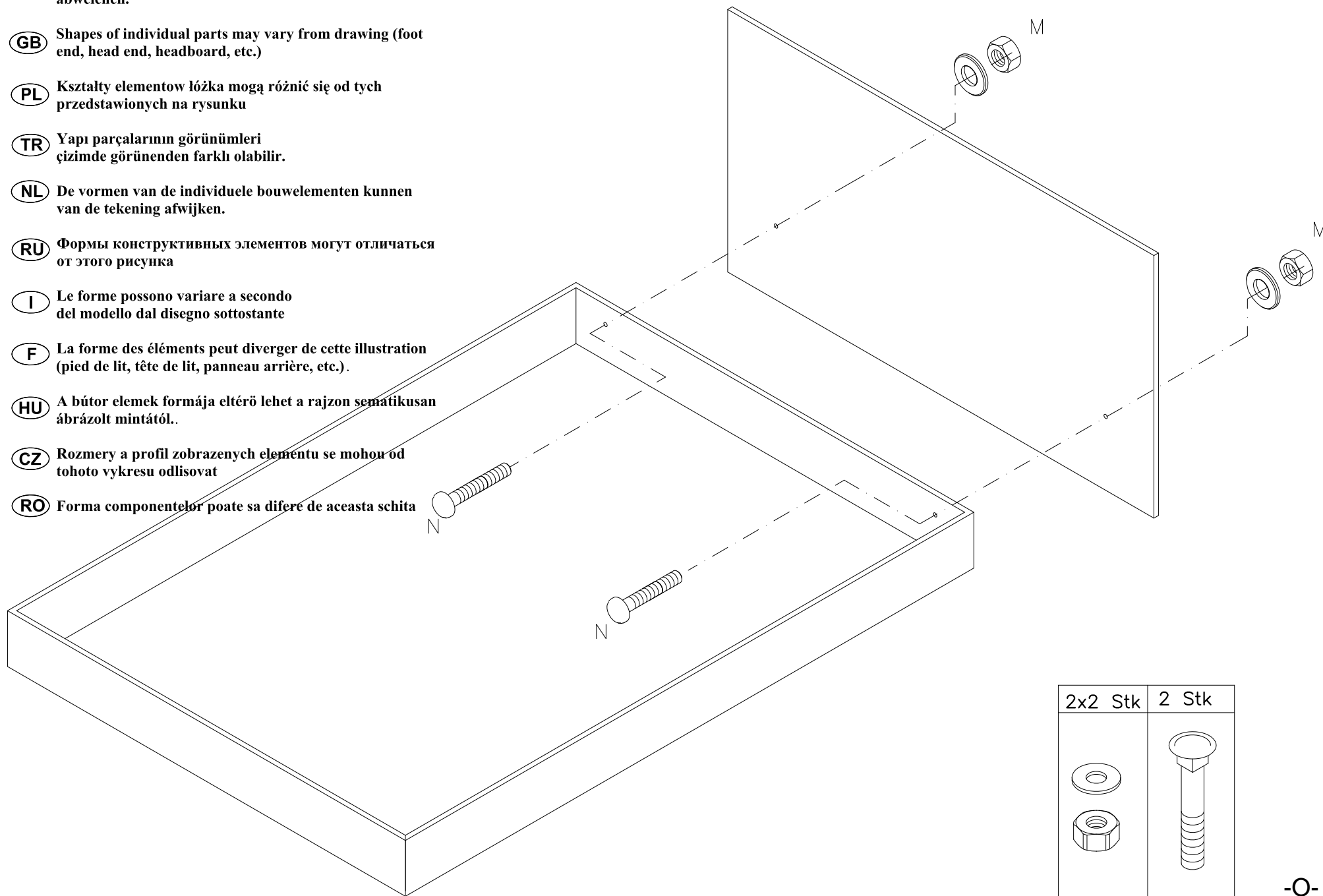

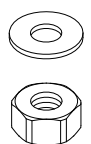
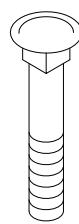
2x2 Stk	2 Stk
	
M	N