

P185 / P208

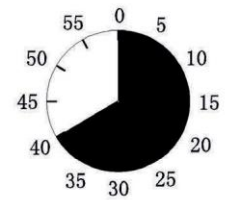

1

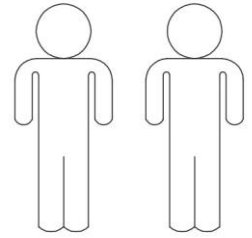
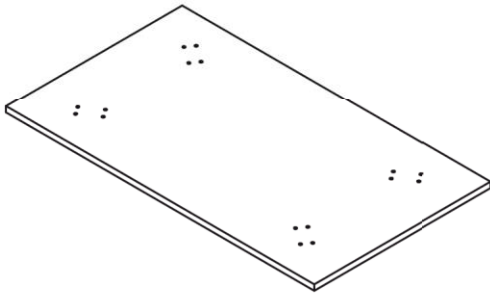

2.1



2.2

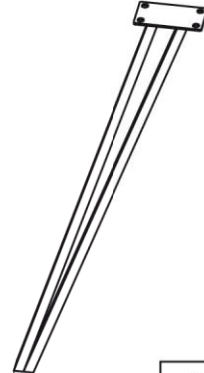



1	1x	1/2
2	4x	2/2

<p>A M8*12 16X</p>	<p>B M8*16 16X</p>	<p>C Ø18*Ø8*1.5 16X</p>	<p>D Ø25 4X</p>	<p>E 5mm 1X</p>
<p>F 8mm 1X</p>				

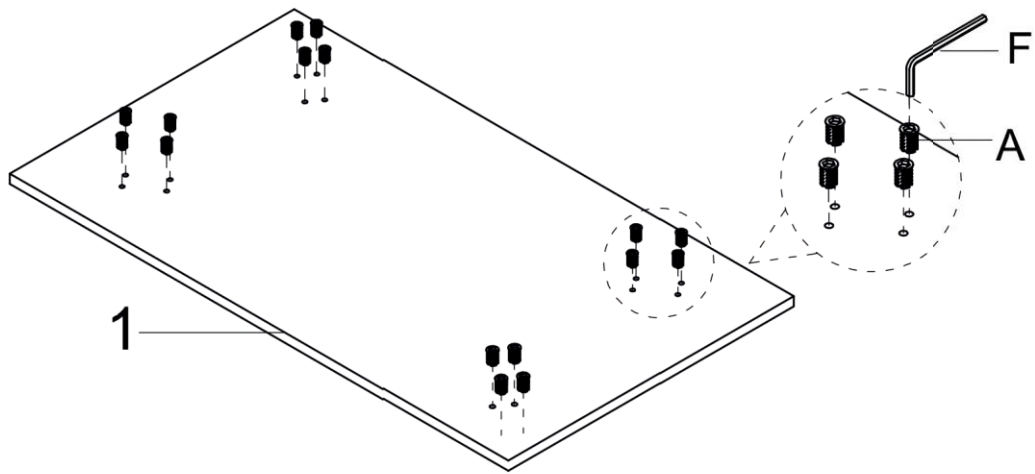



1.
1.

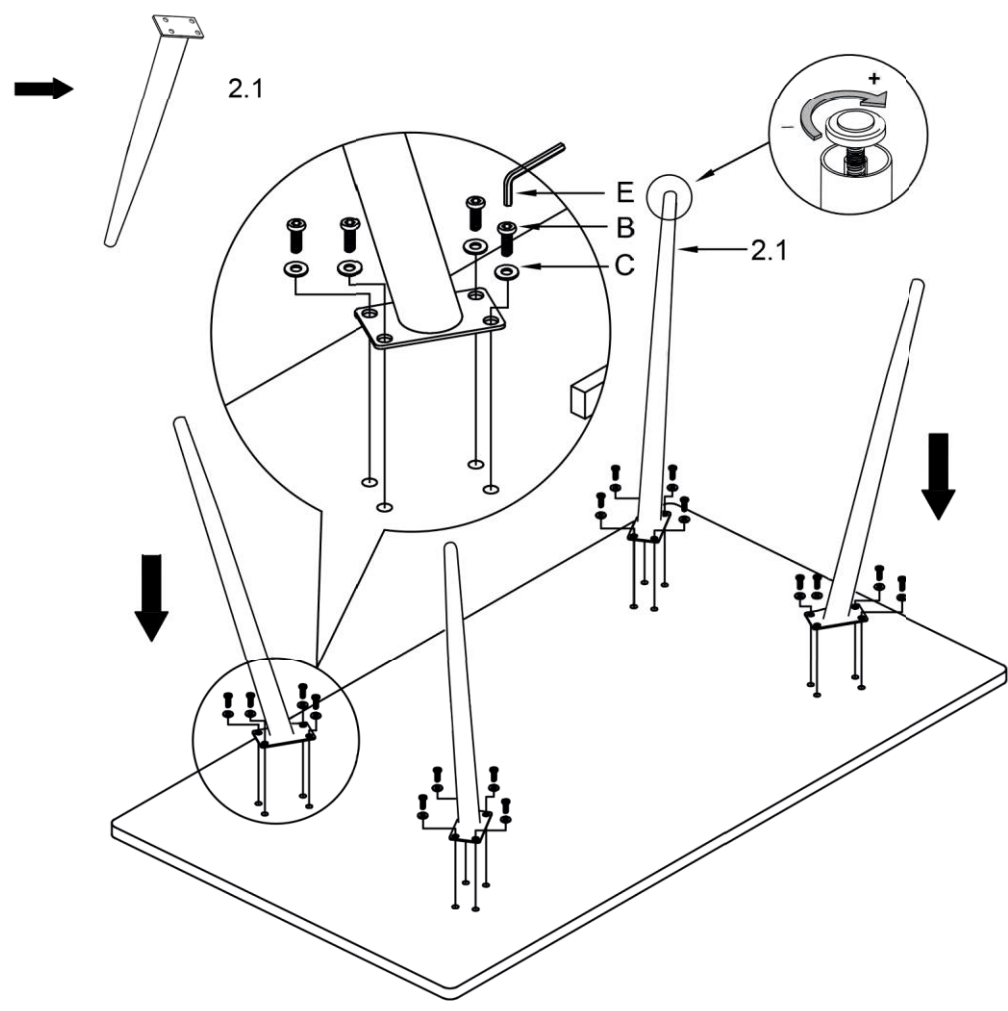

- A  M8*12
16X
- F  8mm
1X
- 

2.1



- B  M8*16
16X
- C  Ø18*Ø8*1.5
16X
- E  5mm
1X
- 

1.
2.2

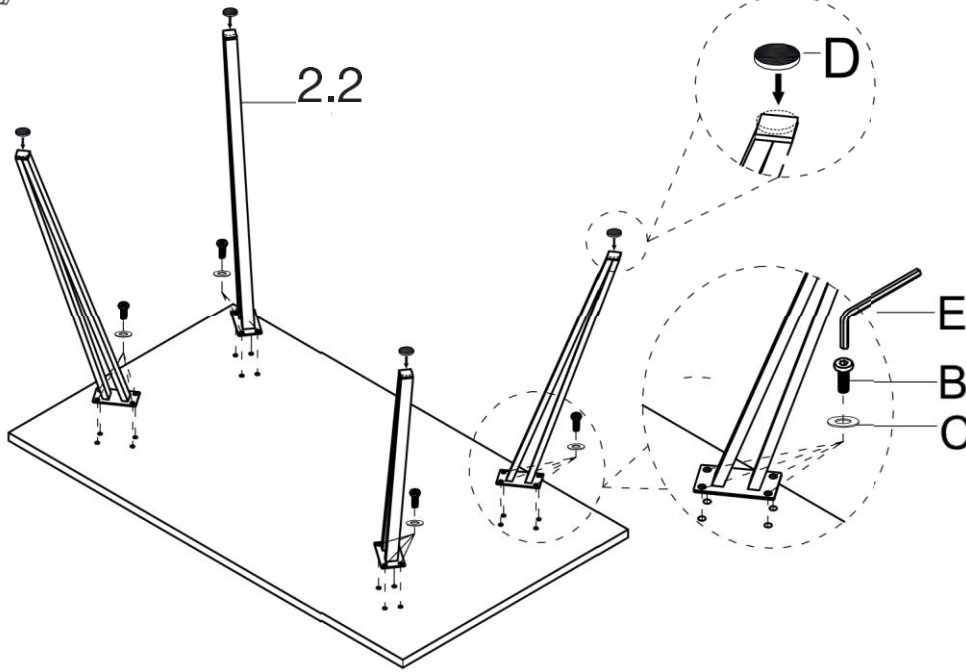
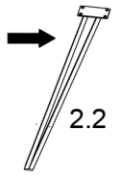

- B M8*16
16X
 - C Ø18*Ø8*1.5
16X
 - D Ø25
4X
 - E 5mm
1X
- 100%

3.

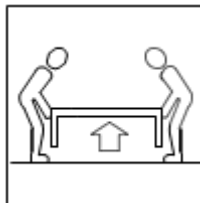
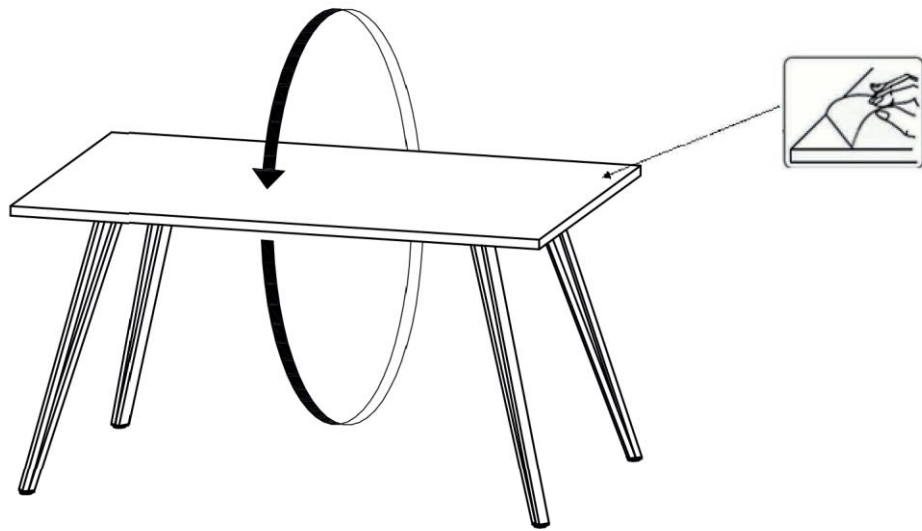
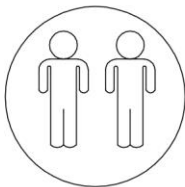

LE TRI + FACILE

Séparez les éléments avant de trier