

Art. Nr. 2822899

1/6



07.08.2018

Art. Nr. 2822899

Groundplan - Grundplan - Plan de masse - Planimetria - Plattegrond - Põhiplaan

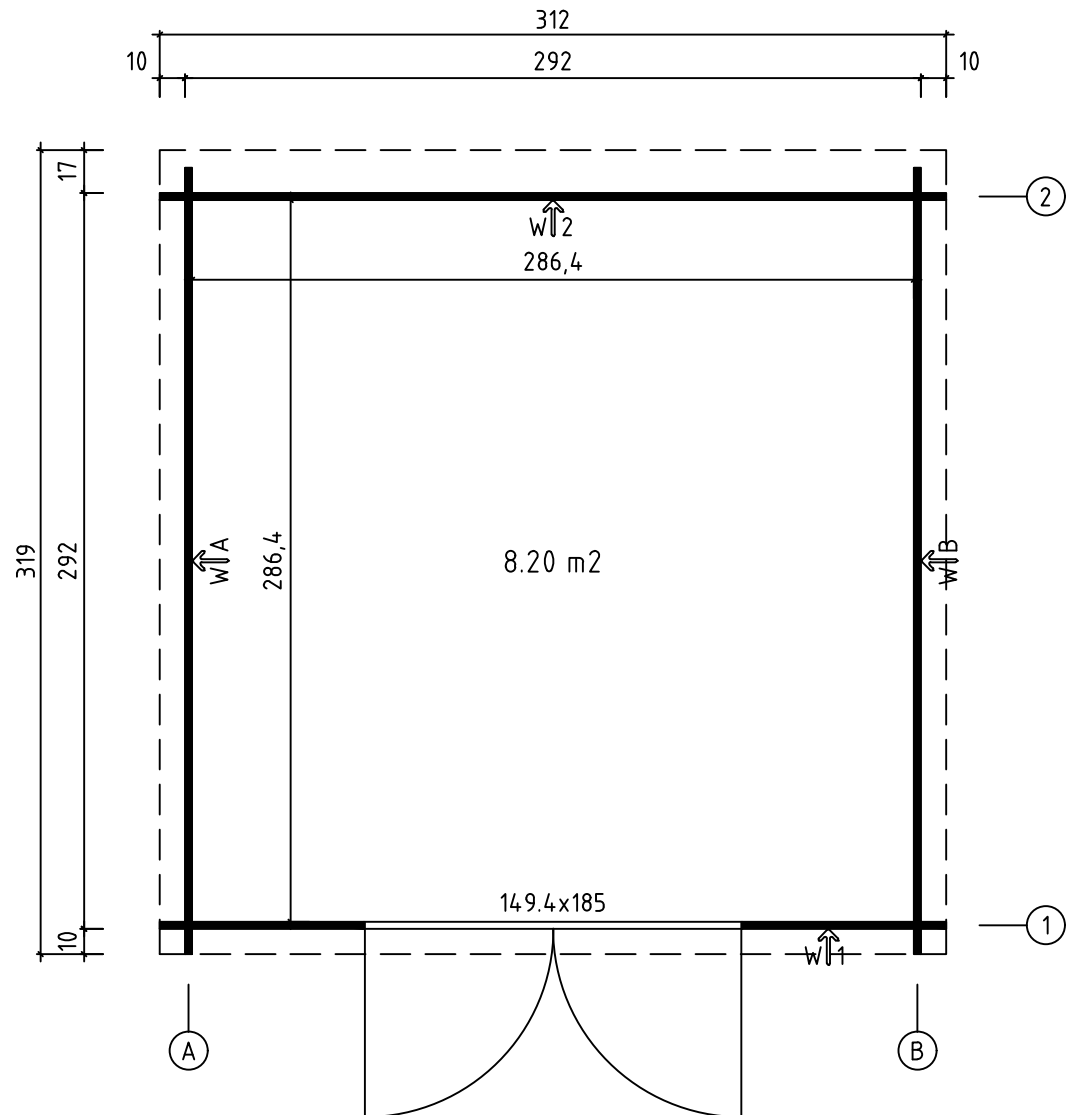



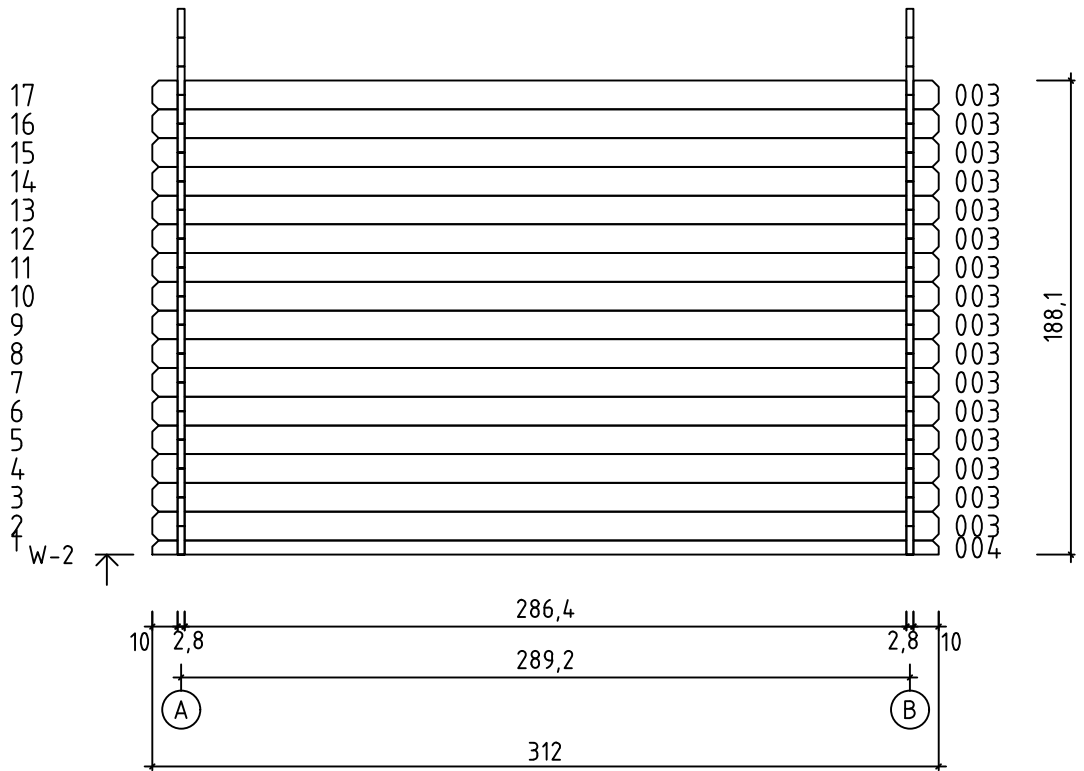
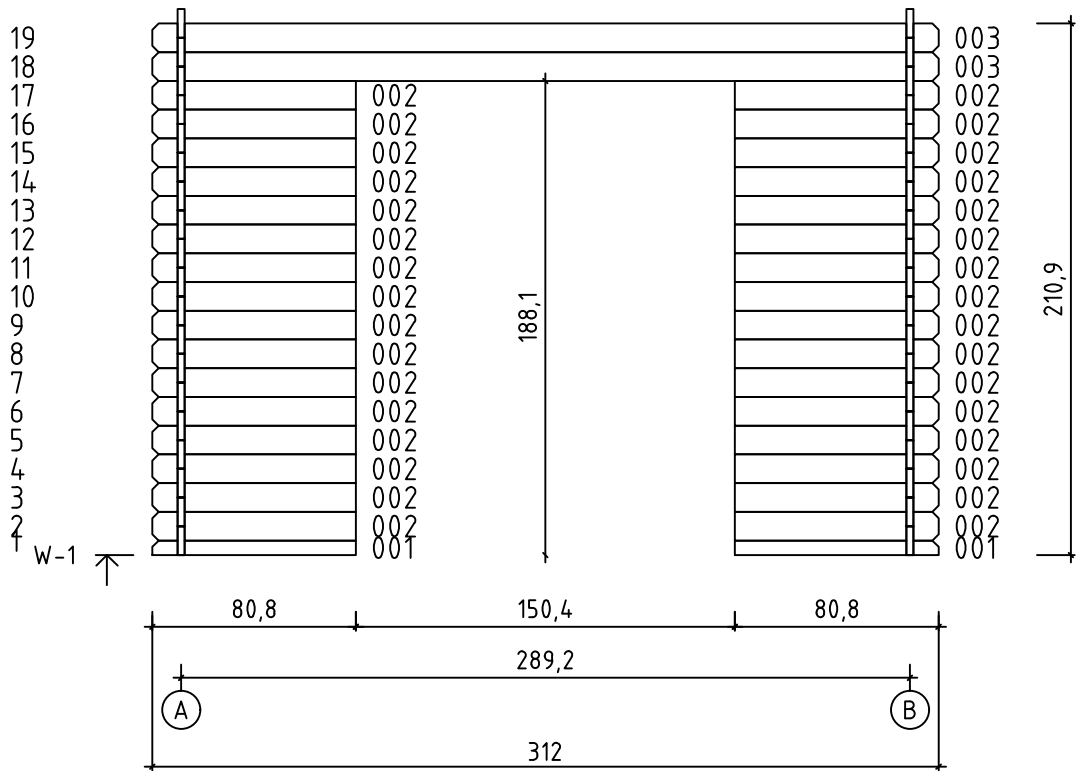



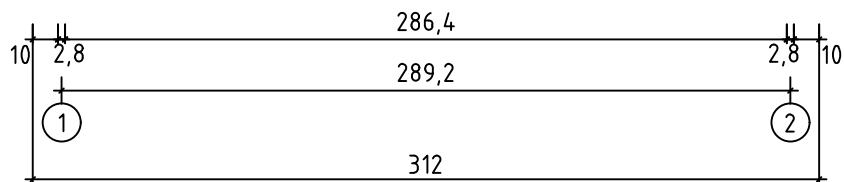
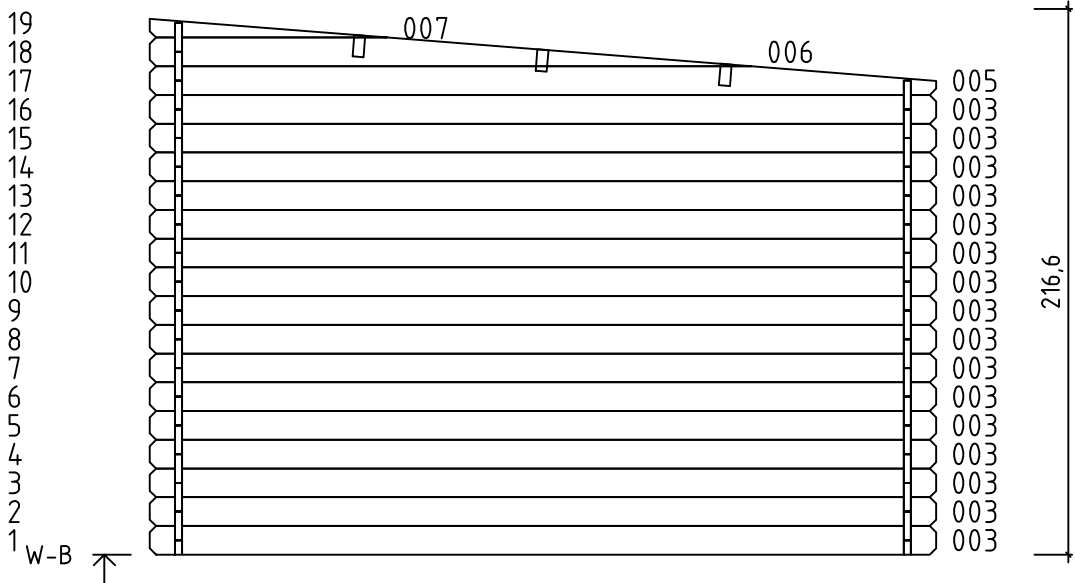
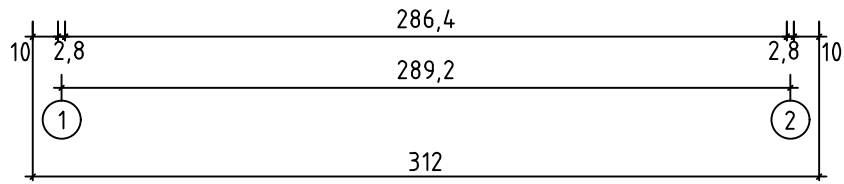
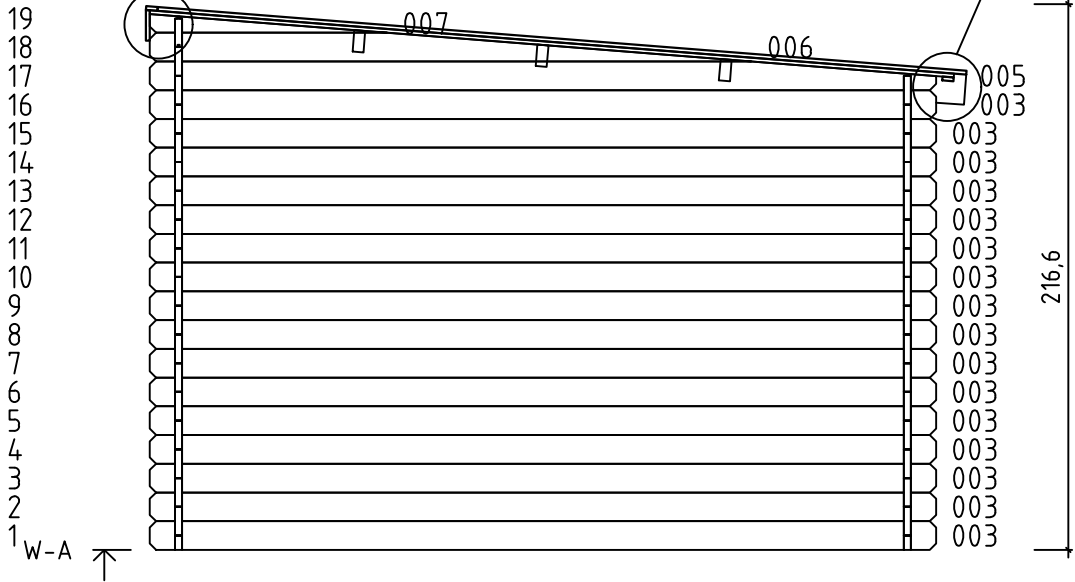
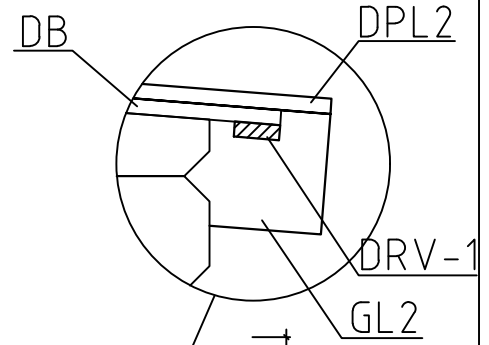
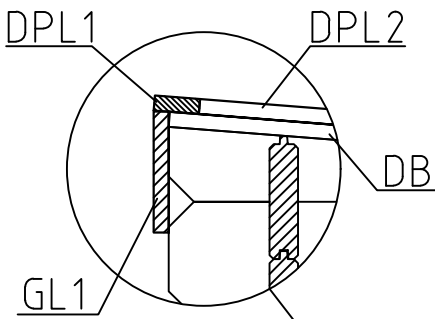

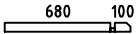
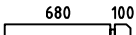
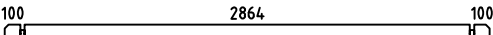
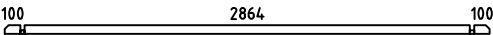
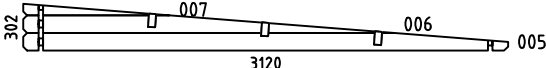
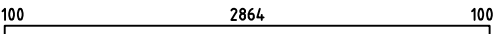

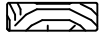
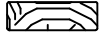
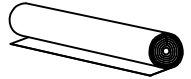
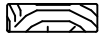
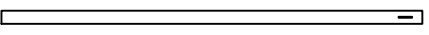
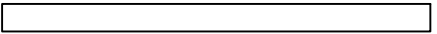
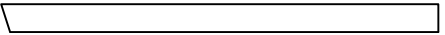
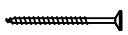
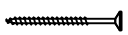
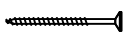

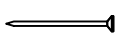

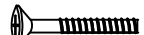

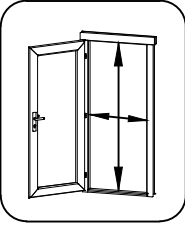
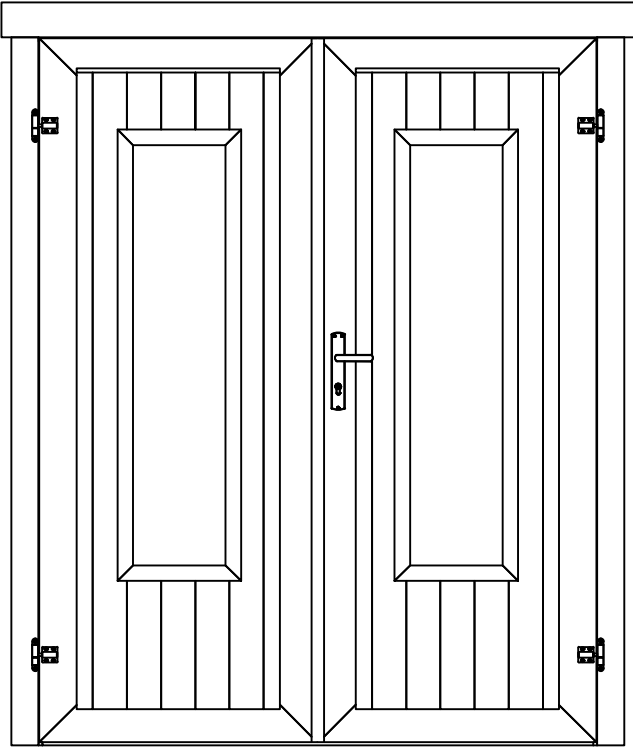
Art. Nr. 2822899



Art. Nr. 2822899



Pos	07.08.2018 Piece list - Stückliste - Liste des pièces - Elementi - Stuklijst - Tükítabel Art. Nr. 2822899 5/6	Q	P (mm)	L (mm)
001		2	28x57	808
002		32	28x114	808
003		50	28x114	3120
004		1	28x57	3120
WA-1 WB-1		1 1		
A-PR1	Roof beam - Dachbalken - Panne de toit - Perlina del tetto - Gordingen / dakbalk - Pärlin 	3	44x95	3120
DB	Roof boards - Dachbretter - Voliges - Perlina per tetto - Dakhout - Katuselaud 	35	90x15	3200
DPL1	Roofing felt fillet - Dachpappenleiste - Baguette de fixation du feutre bitumeux - Asse per fissaggio guaina bituminosa - Afdekljst asfaltpapier - Katussepapiliist 	1	15x45	3150
DPL2	Roofing felt fillet - Dachpappenleiste - Baguette de fixation du feutre bitumeux - Asse per fissaggio guaina bituminosa - Afdekljst asfaltpapier - Katussepapiliist 	2	15x45	3220
DPP-1	Roofing felt (strip) - Dachpappe (bahnen) - Feutre bitumeux (bande) - Cartone catramato - Asfaltpapier (baan) - Katussepapp 	4		3220
DRV-1	Roof edge reinforcement - Dachrandverstärkung - Corniere de renfort de bord de toit - Rinforzo x tetto - Dakrand versterking - Räästatugevdus 	1	15x45	3120
KFS-1	Storm protection - Sturmleiste - Latte anti-tempete - Protezione anti vento - Stormverankering / beveiliging - Tormikinnusliist 	4	22x45	2050
GL1	Gable moulding - Giebelleiste - Planche de rive - Finitura per frontale e retro del tetto - Gevellijst - Viilulaud 	1	15x120	3150
GL2	Gable moulding - Giebelleiste - Planche de rive - Finitura per frontale e retro del tetto - Gevellijst - Viilulaud 	2	15x120	3250
HS9	Screw for gable moulding - Schrauben für giebelleiste - Vis pour fixation planche de rive - Vite per fissare finiture davanti e dietro del tetto - Schroef voor gevellijst - Kruvi viilulauale 	28	3.5x50	
HS4	Screw for roof edge reinforcement - Schrauben für dachrandverstärkung - Vis pour fixation corniere renfort de bord de toit - Viti x rinforzo bordo tetto - Schroef voor dakrand versterking - Kruvi räästatugevdusele 	7	3x30	
HS18	Screw for roof beams - Schrauben für dachbalken - Vis pour fixation pannes de toit - Viti per perline del tetto - Schroef voor gordingen / dakbalken - Kruvi pärlinitele 	10	5x120	
SH28	Hammer block - Schlagholz - Calle de frappe - Blocco di legno da usare come cuscinetto quando si usa il martello - Slagklos - Löögiklots 	1		
SFS	Nut for storm protection - Schraubenmutter für sturmleiste - Erou pour latte anti-tempete - Dado x asta protezione vento - Moer voor stormverankering - Mutter tormikinnusliistule 	8	D6	
NF4	Zn nail for roof - Zn nägel für dachbretter - Pointe pour fixation voliges de toit - Chiodi x perline tetto - Spijker(nagel) voor dakhout - Nael katuselauale 	188	2x50	
NF5	Zn nail for roofing felt fillet - Zn nägel für dachpappenleiste - Pointe pour baguette de fixation feutre bitumeux - Chiodi x carta bituminosa x tetto - Spijker(nagel) voor asfaltpapier afdekljst - Papiliistunael 	21	2x40	
NF6	Roofing nails for roofing felt - Nägel für dachpappe - Pointe pour fixation feutre bitumeux - Chiodi per cartone catramato - Asfaltnagel - Papinael 	110	2.8x15	
BFS	Bolt for storm protection - Bolzen für sturmleiste - Boulon pour latte anti-tempete - Bullone x asta protezione vento - Bout voor stormankerlat - Puidupolt tormikinnusliistule 	8	6x60	

Pos	03.08.2018	Piece list - Stückliste - Liste des pièces - Elementi - Stuklijst - Tükitalabel 14.94x1850 TUK.2.030.XVP.MX28 XGA+28	1/2	Q	P (mm)	L (mm)
Glass size - Glasgröße - Taille de la vitre - Misura del vetro - Glas afmeting - Klaasi mõõt: 262x1098 mm				 1418x1794 mm		
						
1	Upper door jamb - Türrahmen oben - Cadre de porte supérieur - Telaio superiore della porta - Bovendorpel - Ukse ülemine leng		1	66x100	1628	
2	Left door jamb - Türrahmen links - Cadre de porte gauche - Telaio montante sinistro della porta - Linkerstijl deurframe - Ukse vasak leng		1	66x80	1850	
3	Right door jamb - Türrahmen rechts - Cadre de porte droit - Telaio montante destro della porta - Rechterstijl deurframe - Ukse parem leng		1	66x80	1850	
4	Doorstep - Swelle - Barre de seuil - Soglia della porta - Deurdorpel - Lävepak		1	18x18	1418	
5	Connection strip - Deckleiste - Baguette de battement - Profilo verticale della porta - Stulpelijst - kokkuvaltsiliist		1	13x32	1812	
6	Window fillet - Glasleiste - Cadre de vitre - listello per finstra - Glaslijst - Klaasiliist		4	20x40	318	
7	Window fillet - Glasleiste - Cadre de vitre - listello per finstra - Glaslijst - Klaasiliist		4	20x40	1162	
8	Window fillet - Glasleiste - Cadre de vitre - listello per finstra - Glaslijst - Klaasiliist		4	10x40	318	
9	Window fillet - Glasleiste - Cadre de vitre - listello per finstra - Glaslijst - Klaasiliist		4	10x40	1162	
10	Glass - Glas - Vitre - Vetro - Glas - Klaas		2			

