

(PL) Instrukcja montażu

(CZ) Návod k montáži

(D) Montageanleitung

(GB) Assembly instruction

(F) Model d'emploi

(HU) Szerelési útmutató

(I) Istruzione di montaggio

(NL) Handleiding voor de montage

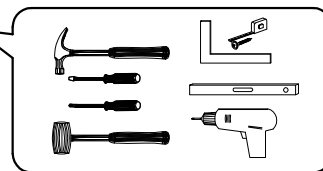
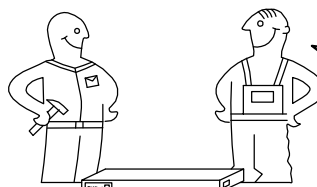

(RU) Инструкция по монтажу

(RO) Instrucțiuni de montare

(SK) Návod k montáži





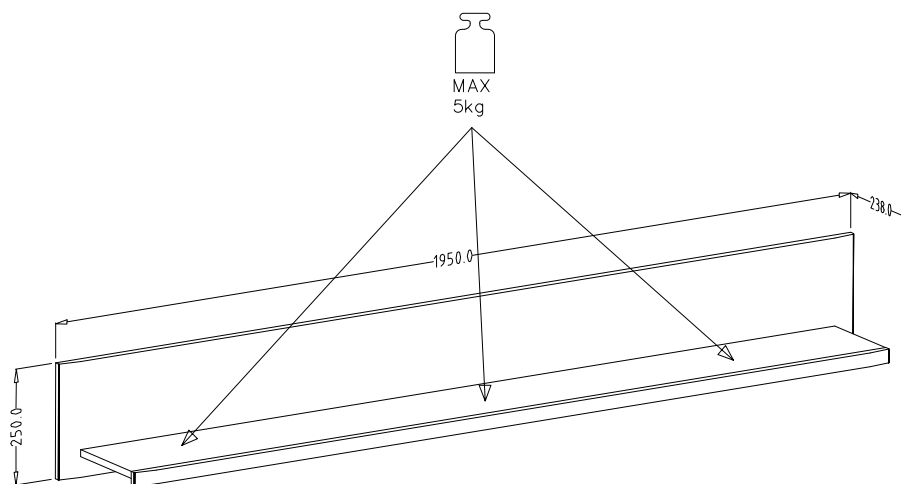
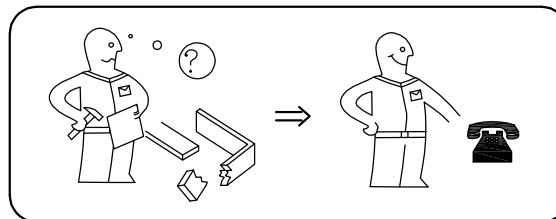
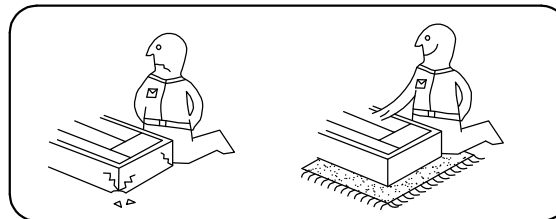

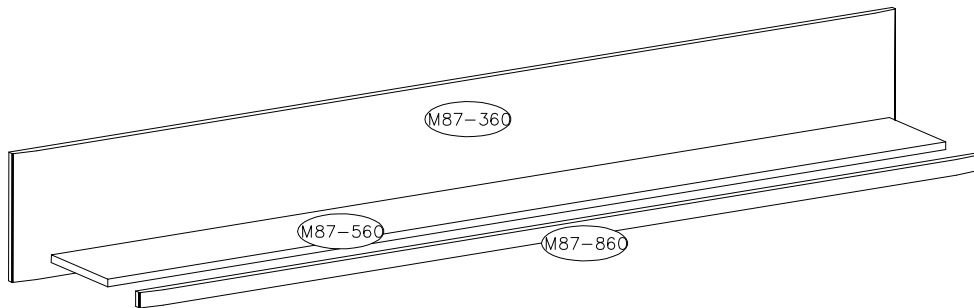
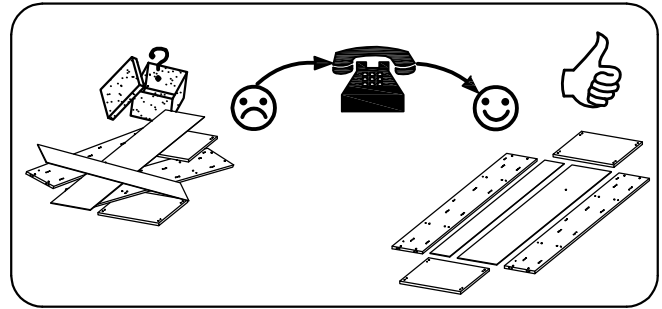
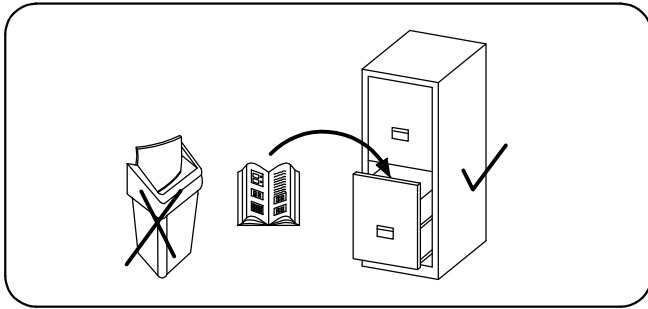

(TR) Montaj talimatı

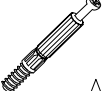
Uwaga • Upozornění • Achtung • Attention • Caution • Figyelem Attenzione • Opgelet • Внимание • Atenție • Upozornenie • Dikkat	
PL	Czyszczenie należy wykonać wyłącznie za pomocą ściereczki lub lekko nawilżonego ręcznika. Nie stosować środków czyszczących do szorowania.
CZ	Čistění je nutné vykonávat výhradně pomocí utěrky nebo lehce navlhčeného ručníku. Nepoužívejte čisticí prostředky obsahující abrazivní částice.
D	Bitte nur mit einem Staubtuch oder leicht feuchtem Lappen reinigen. Keine scheuernden Putzmittel verwenden.
GB	Please only clean with a duster or a damp cloth. Do not use any abrasive cleaners.
F	Le nettoyage se fait uniquement à l'aide d'un torchon ou d'une serviette légèrement mouillée.
HU	A tisztítás kizárólag törölrőruha vagy enyhén nedvesített törölköző segítségével végezhető. Súroló hatású tisztítószerket nem szabad használni.
I	Pulire esclusivamente con un panno o un asciugamano umido.
NL	Reinig alleen met een stofdoek of een lichtjes vochtige doek. Gebruik geen schurende poetsmiddelen.
RU	Очищайте от пыли тряпкой или слегка влажной ветошью. Не допускается применение чистящих средств, не предназначенных для ухода за мебелью.
RO	Curățarea trebuie efectuată numai cu o cârpă sau cu un prosop ușor umezit. Nu utilizați agenți de curățare abrazivi.
SK	Čistení je nutné vykonávať výhradne pomocí utierky alebo ľahko zvlhnutým ručníkom. Nepoužívajte čistiace prostriedky obsahujúci abrazívne častice.
TR	Lütfen sadece bir toz bezilye veya hafif nemli yumuşak bir bezle siliniz. Aşındırıcı temizlik malzemeleri kullanmayınız.







MADISON WM 02

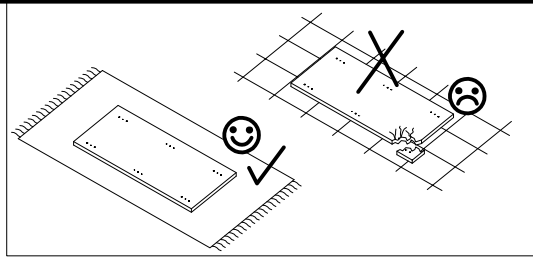

			8.0X30 	6.4X50 	4mm 		3.5X16 	
A	B	C	D	K1	K3	Q1	W1	N9
4	4	4	5	6	1	2	4	3



1

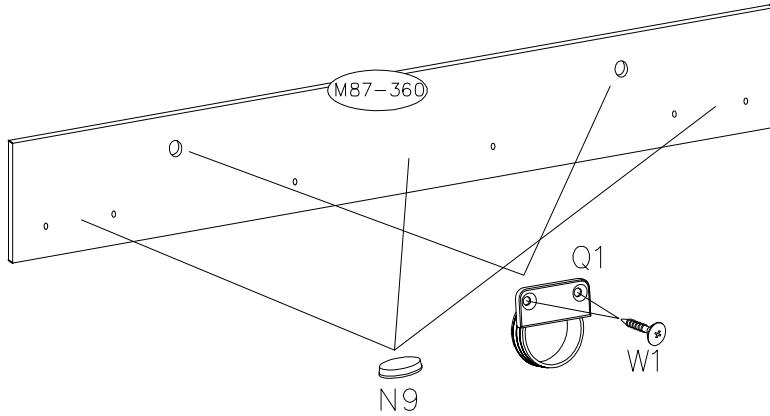

 Q1	3.5X16  W1	 N9
2	4	3



2

 A	 B	8.0X30  D
4	4	5

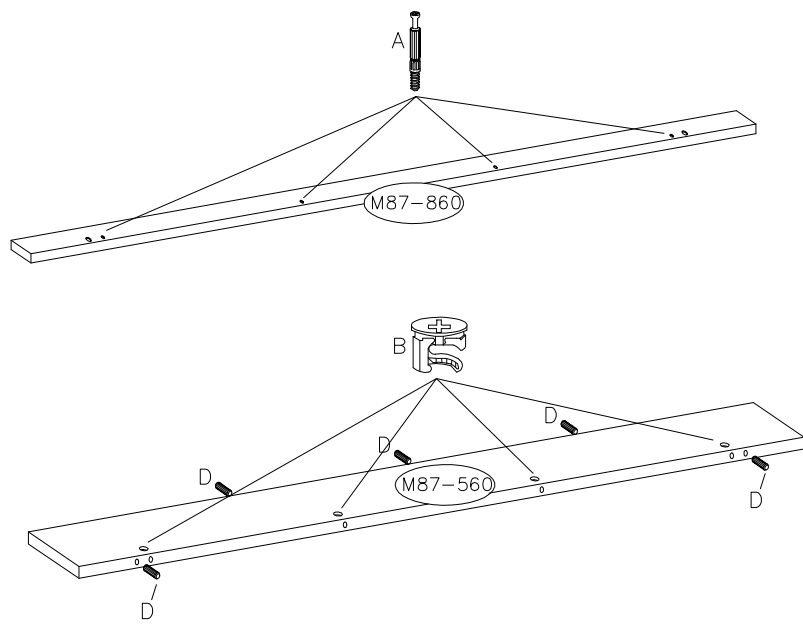

3

6.4X50



K1

6

4mm



K3

1

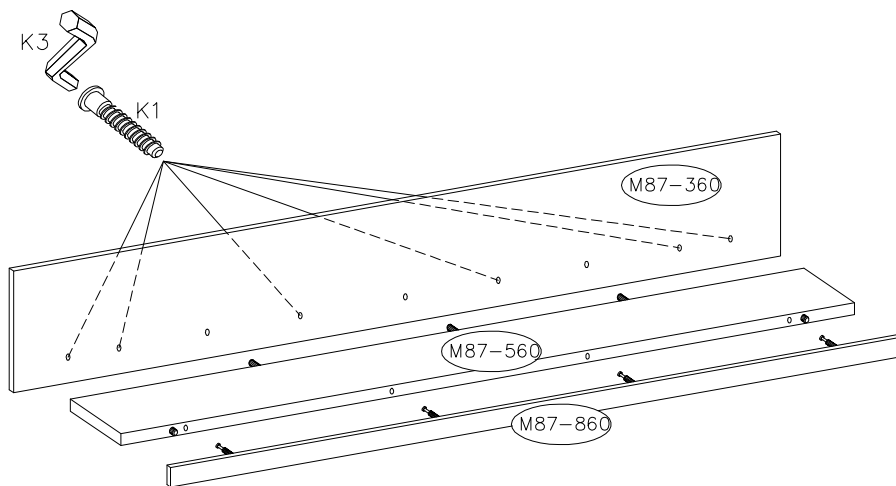

4

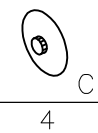
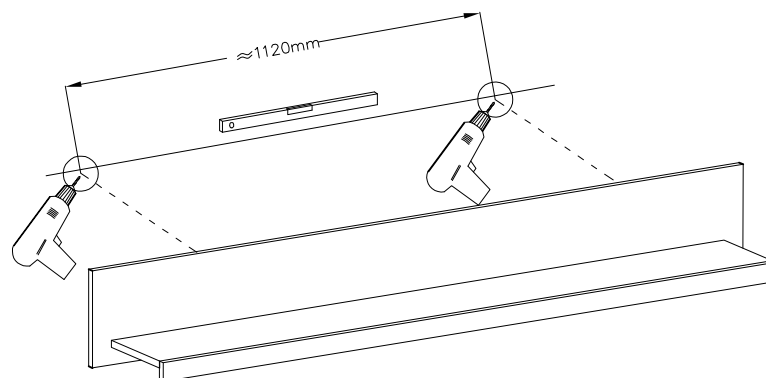

4

⚠ Uwaga • Upozorneni • Achtung • Attention • Caution • Figyelem • Attenzione • Opgelet • Внимание • Atentie • Upozornenie • Dikkat ⚠

PL	Mocowanie mebla do ściany może przeprowadzić wyłącznie odpowiedni do tego personel, ponieważ w czasie montażu w ścianie konieczne jest zastosowanie dopasowanych kółków.
CZ	Připevnění nábytku ke stěně může uskutečnit výhradně k tomu určený personál, protože pro montáž je nutné použít hmoždinky shodné s typem a tloušťkou stěny.
D	Die Befestigung des Möbelstückes an der Wand muss von einer fachkundigen Person vorgenommen werden, da für die Montage an die Wand angepasste Dübel erforderlich sind.
GB	A qualified professional is required when mounting furniture to the wall since dowels corresponding to the wall are required for this.
F	Le montage du meuble au mur peut être fait uniquement par le personnel spécialisé. Il est nécessaire d'utiliser des chevilles bien ajustées pendant le montage au mur.
HU	A bűtor a falhoz való rögzítését kizárólag erre illetékes személyzet végezheti, mivel a falhoz való rögzítés során megfelelő méretű csapszeg alkalmazása szükséges.
I	Attaccare un mobile alla parete può essere effettuato esclusivamente dal personale adatto perche' durante il montaggio bisogna usare dei cavicchi adatti.
NL	een vakkundige persoon dient het meubelstuk aan de muur te bevestigen; voor de montage aan de muur zijn immers aangepaste pluigen vereist.
RU	Поскольку для монтажа на стене необходимо использовать специальные дюбели, мебель должна быть закреплена на стене квалифицированным персоналом.
RO	Montarea mobilei pe perete poate fi efectuată numai de către personalul calificat deoarece la această montare se folosește cepuri.
SK	Pripevnění nábytku k stěně může uskutečnit výhradně k tomu určený personál, pretože k montáži je nutné použiť hmoždinky zhodné s typom steny a jej hrúbkou.
TR	Möbilya parçasının duvara sabitlenmesi, duvar montajı için özel uyarlanmış dübeller gerektirdiğinden bu iş sadece bu konuda uzman bir kişi tarafından gerçekleştirilmelidir.

