

"Frieda" 520/861

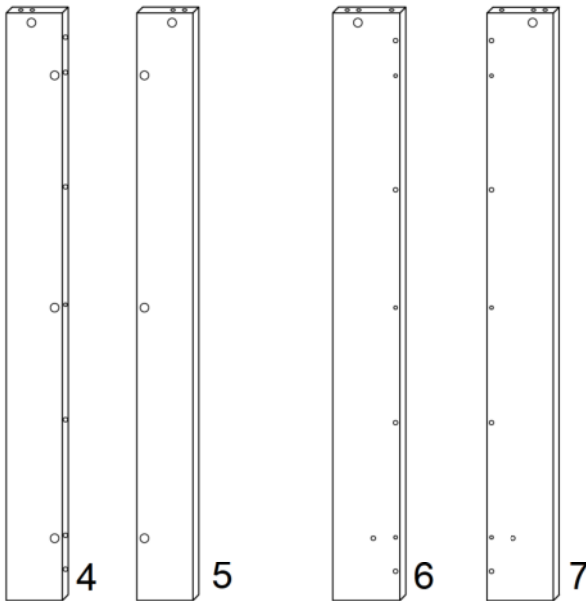
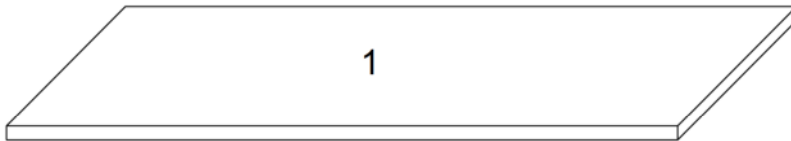
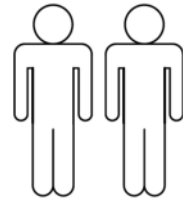
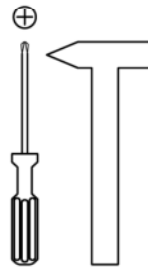
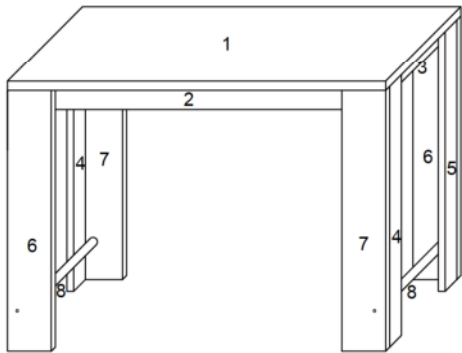

1	1 x
2	2 x
3	2 x
4	2 x
5	2 x
6	2 x
7	2 x
8	2 x

A	20x	B	20x	C	8x30 28x	D	4x35 32x	E	4x20 4x	F	2x
G	D=16mm 12x	H	12x	J	L=45 mm 4x	K	SW 4 1x	L	2x		

I.

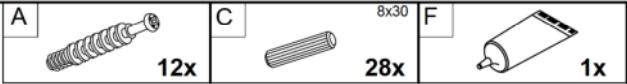

1.

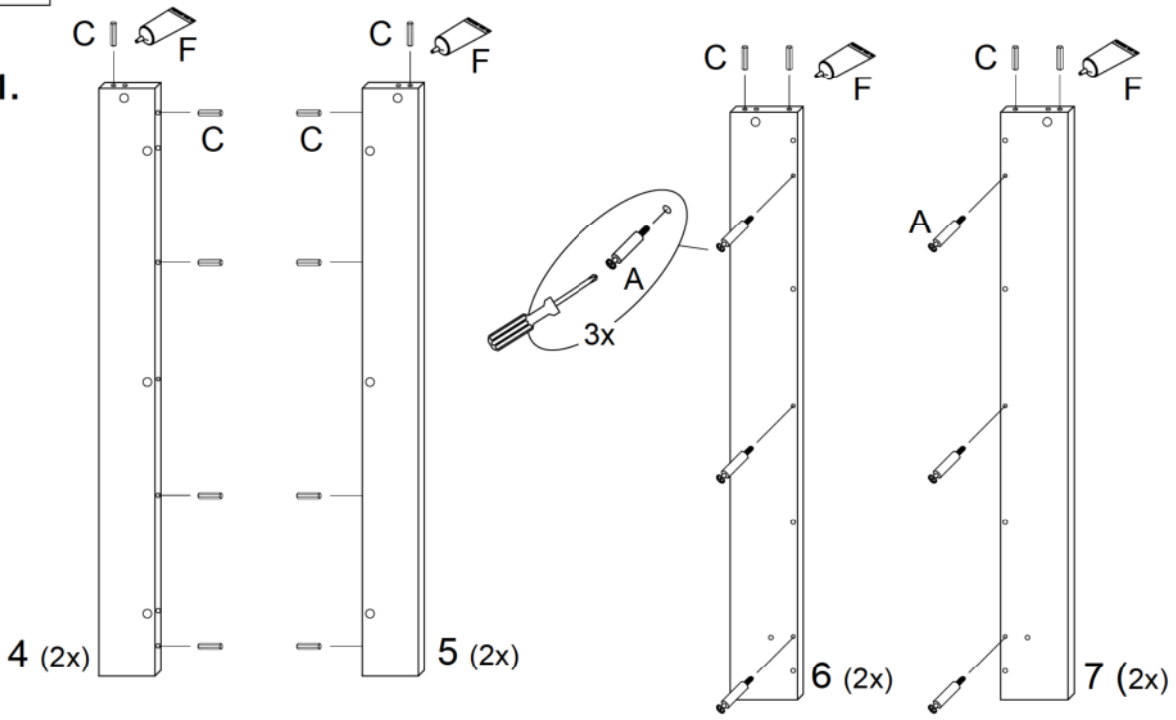

2.

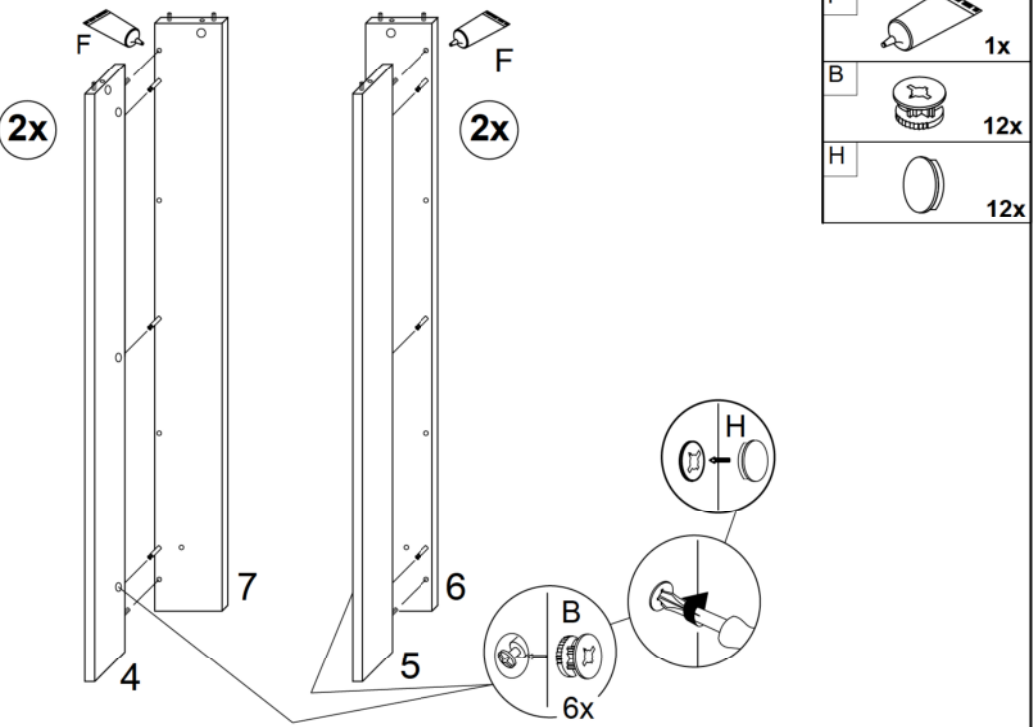

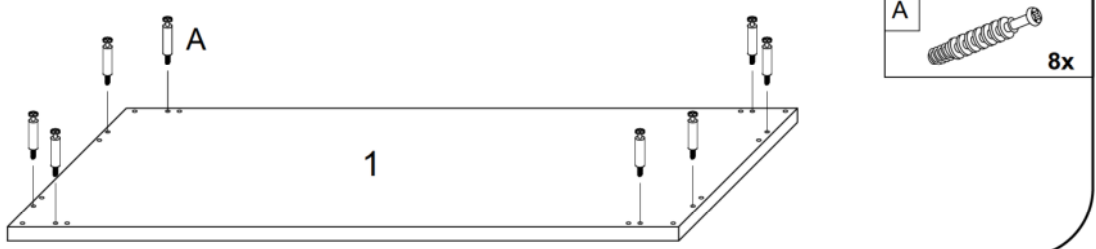

3.



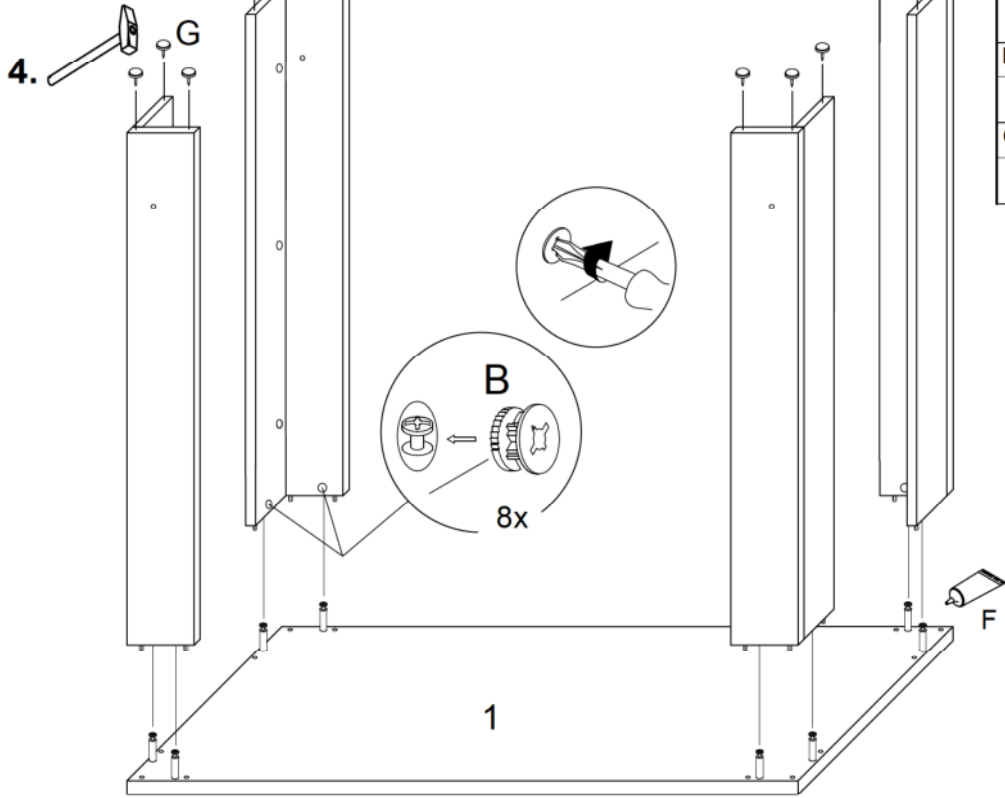





II.

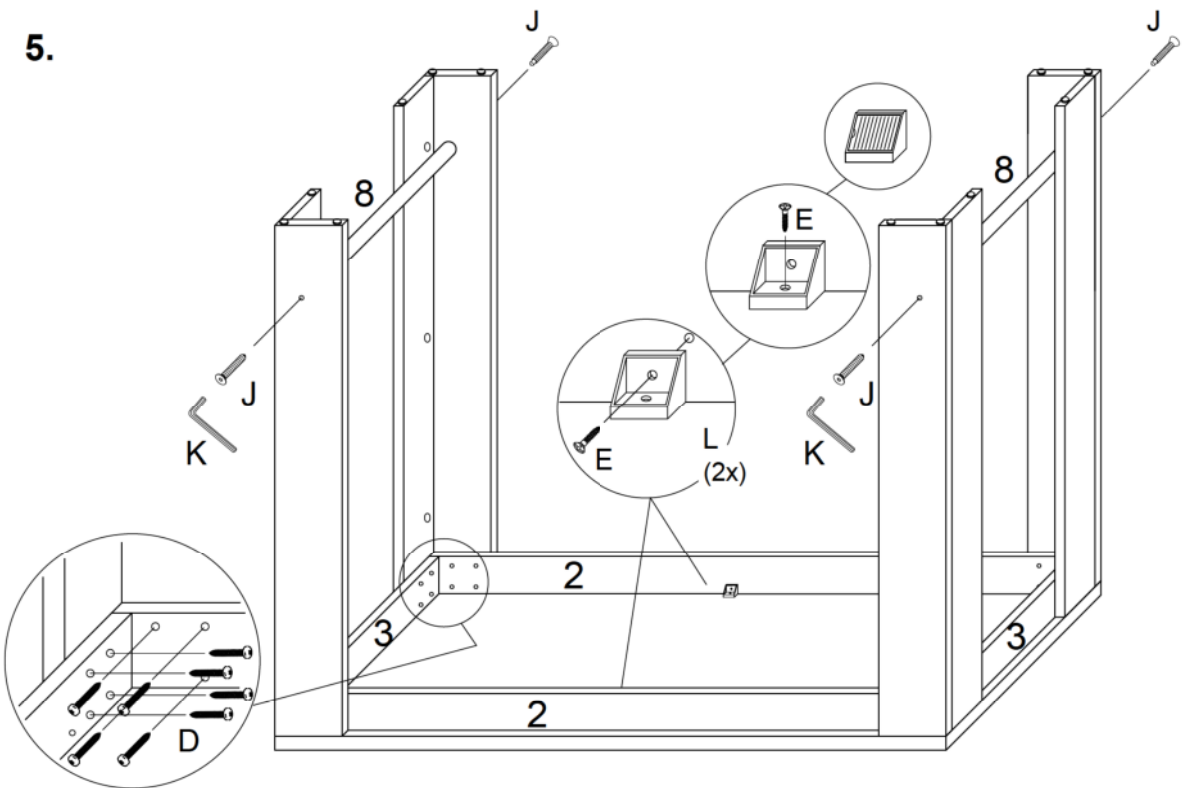

- F  1x
- B  8x
- G  D=16mm 12x

5.



- D  4x35 32x
- E  4x20 4x
- J  L=45 mm 4x
- K  SW 4 1x
- L  2x

III.

6.

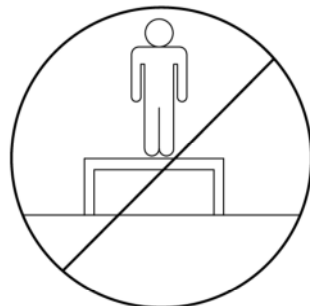
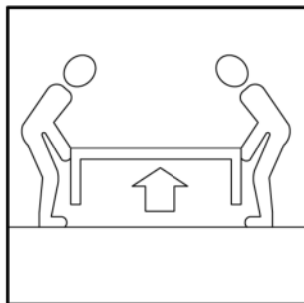
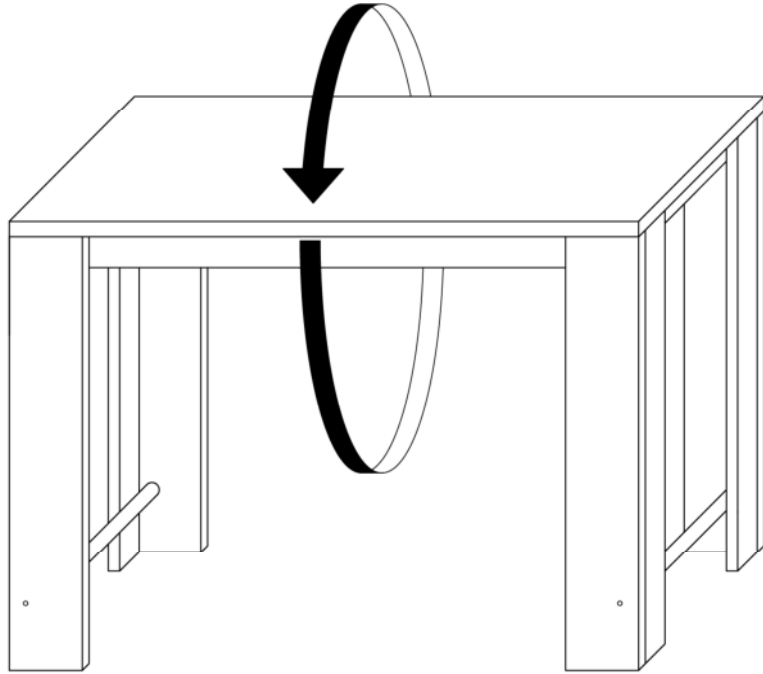
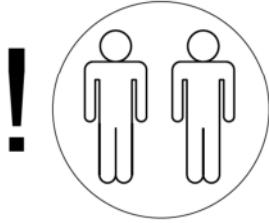

YVONNE

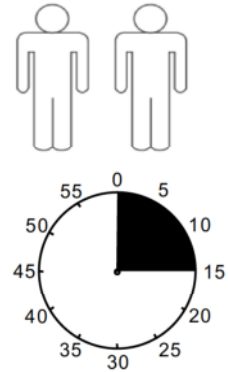
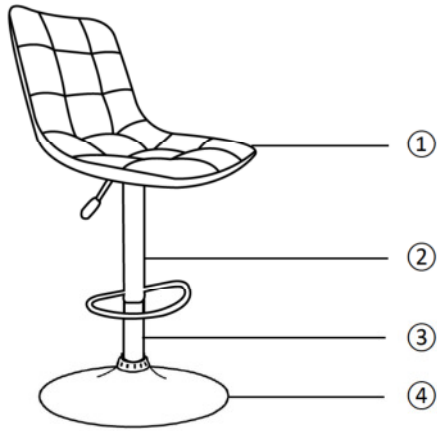

1

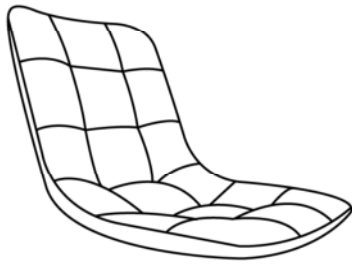

2

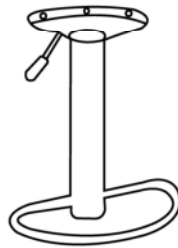

3



4

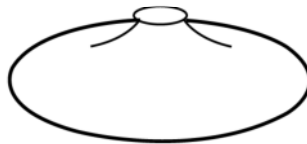

1	1x
2	1x
3	1x
4	1x

A



1X

B



M6X16

2X

C



M6X25

2X

D



1X

I.

1.

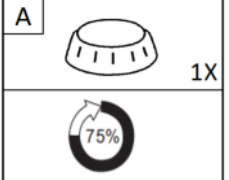
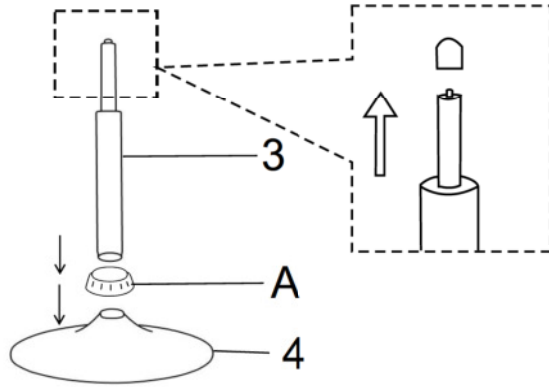

2.

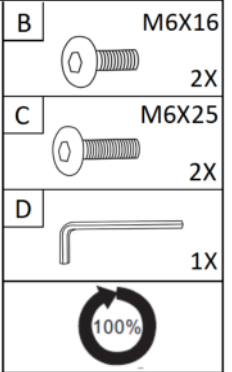
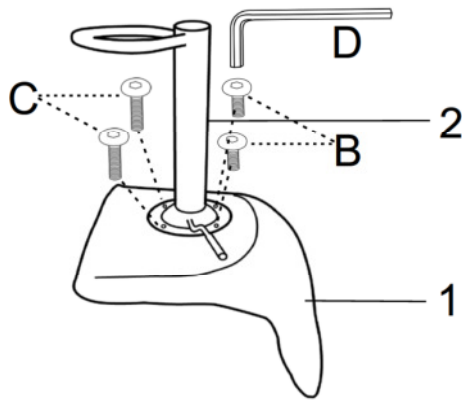

3.

