

P185 / P208

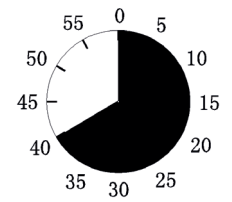

1

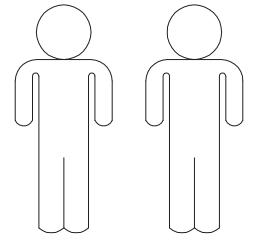
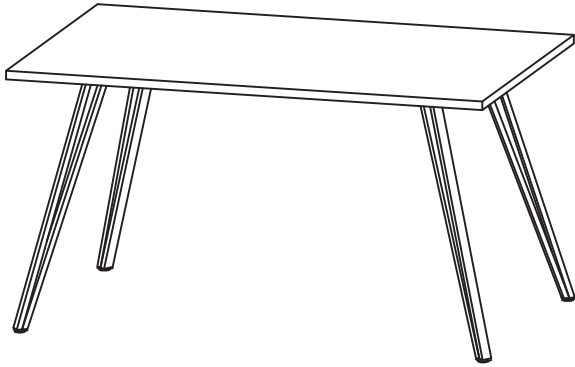
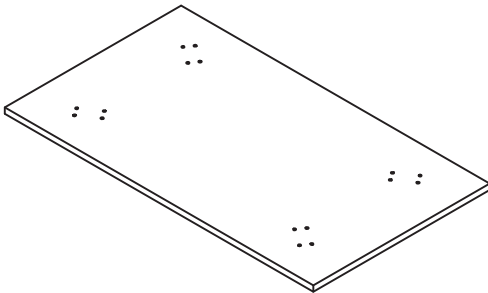

2

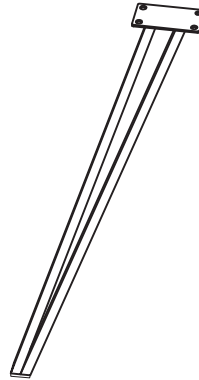

1	1x	1/2
2	4x	2/2

A	M8*12 16X	B	M8*16 16X	C	Ø18*Ø8*1.5 16X	D	Ø25 4X	E	5mm 1X
F	8mm 1X								

I.

1.

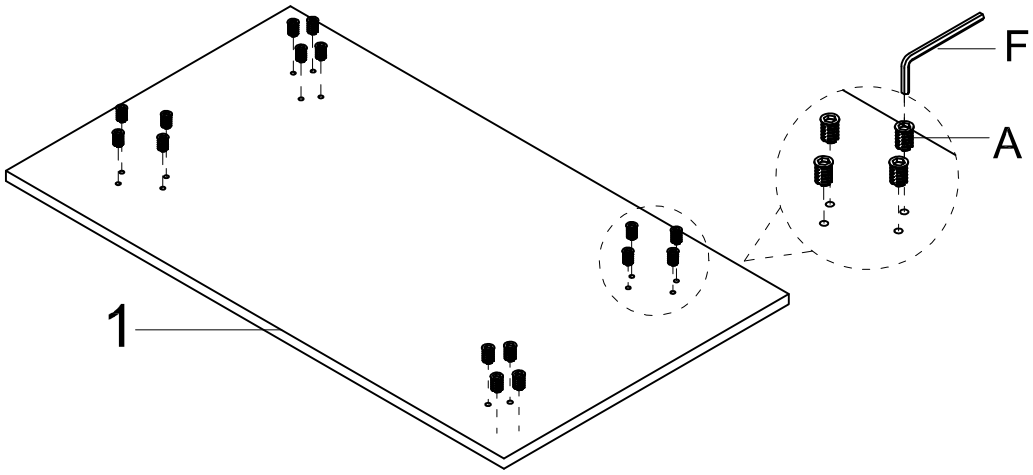

A

M8*12
16X

F

8mm
1X



2.

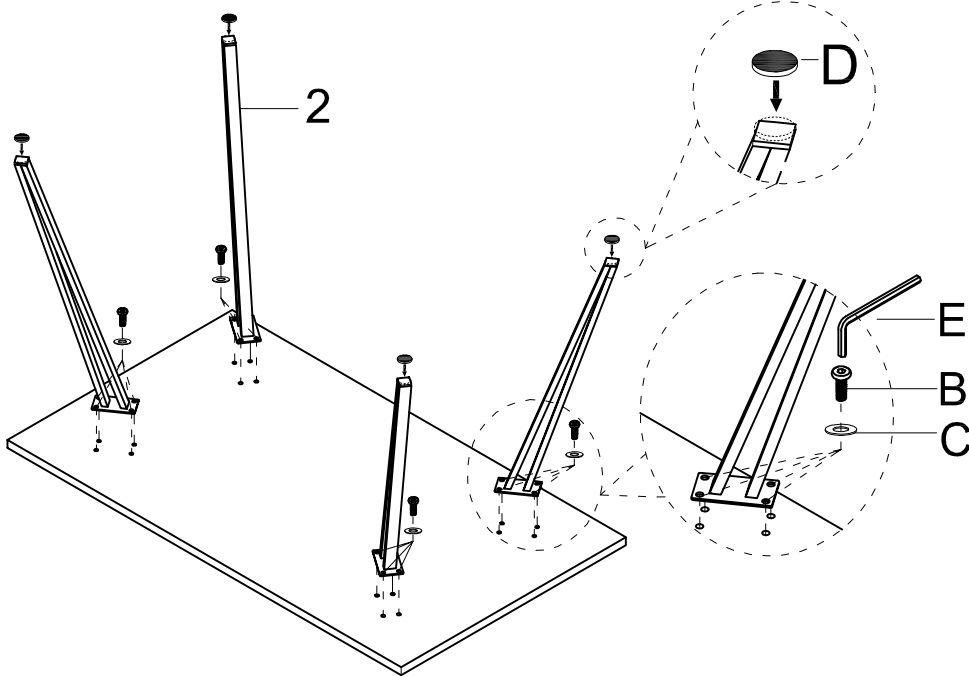

B

M8*16
16X

C

Ø18*Ø8*1.5
16X

D

Ø25
4X

E

5mm
1X



3.

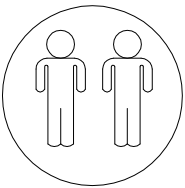

!

