

<http://www.bega-gruppe.de>

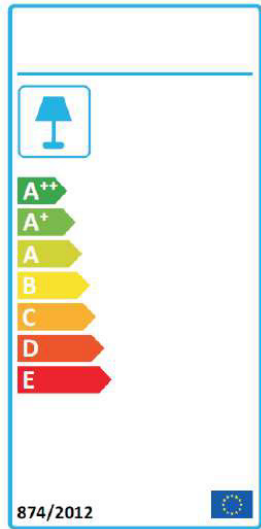

A	B	C	D
1	L29-002	1250x268	1/3
2	L29-103A	1964x180	3/3
3	L29-104A	1964x180	3/3
4	L29-105A	1728x459	2/3
5	L29-501	750x190	1/3
6	L29-502	750x190	1/3
7	L29-503	734x80	1/3
8	L29-504	1850x560	2/3
9	L29-505	1180x190	1/3
10	L29-506	410x307	1/3
11	L29-507	370x307	1/3
12	L29-508	1850x180	2/3
13	L29-511	1850x160	2/3
14	L29-701A	460x60	2/3
15	L29-702A	460x60	2/3
16	L29-704	1852x60	3/3
17	L29-705	1428x15	2/3
18	L29-901	1190x744	1/3
19	MZ1-708	326x70	2/3
20	D 13-702	1880x25	3/3
21	ZZ1-719	1983x70	3/3



BG	CS	DA	DE	ET	EL	EN	ES	FR	FI	HR	HU	IT	LV	LT	NL	PL	PT	RO	SK	SL	SV
Bulgarisch	Tschechisch	Dänisch	Deutsch	Estnisch	Griechisch	Englisch	Spanisch	Französisch	Finnisch	Kroatisch	Ungarisch	Italienisch	Lettisch	Litauisch	Niederländisch	Polnisch	Portugiesisch	Rumänisch	Slowakisch	Slowenisch	Schwedisch
български	čeština	Dänisk	Deutsch	Eesti	ελληνικά	English	español	Français	suomalainen	hrvatski	magyar	italiano	Latvijas	Lietuvos	Nederlands	Polski	português	român	slovenský	slovenščina	Svenska

4x $\phi 10 \times 5,2 \times 20$ mm o89

2x o78/1

1x o78

3x 545x40x5 n96

4x c37

10x $\phi 7 \times 50$ mm e1

18x $\phi 6,3 \times 13$ mm e2

8x $\phi 6 \times 13$ mm e3

6x $\phi 7 \times 70$ mm e27

22x $\phi 8 \times 30$ mm f1

21x $\phi 10 \times 40$ mm f27

6x $\phi 6 \times 50$ mm f36

10x k1

8x k34

2x n34'

2x n34'

2x 90x50/1,5mm n148

2x 104x70x70/2mm n172

12x $\phi 4 \times 30$ mm p9

16x $\phi 4 \times 40$ mm p10

6x $\phi 3,5 \times 25$ mm p16

24x $\phi 3,5 \times 16$ mm p38

18x $\phi 5 \times 20$ mm p45

16x $\phi 15 \times 12$ mm #16 r1

10x $\phi 15 \times 15$ mm #22 r3

26x r42

1x y1

1x z1

1

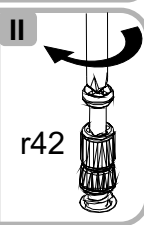
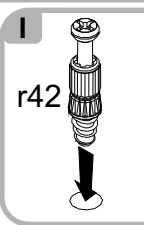
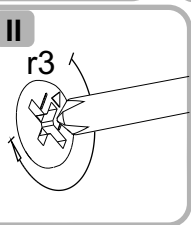
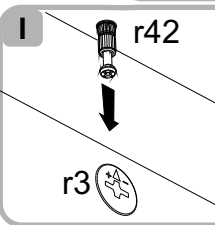
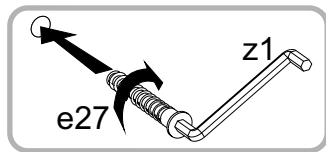
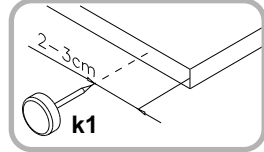
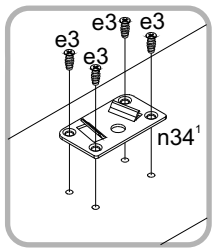
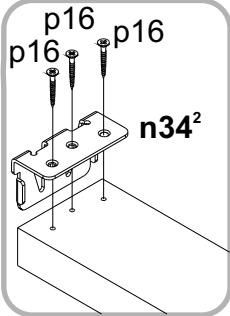
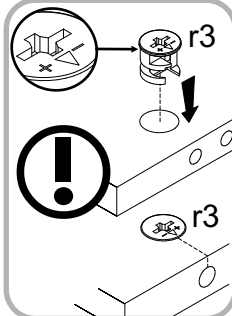
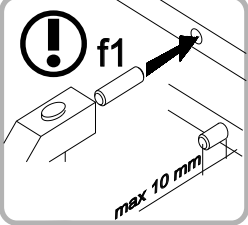
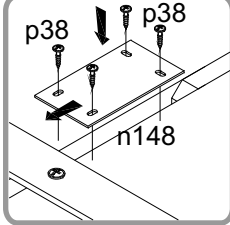
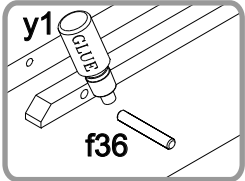
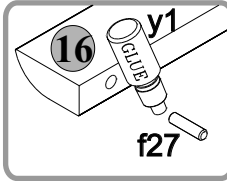
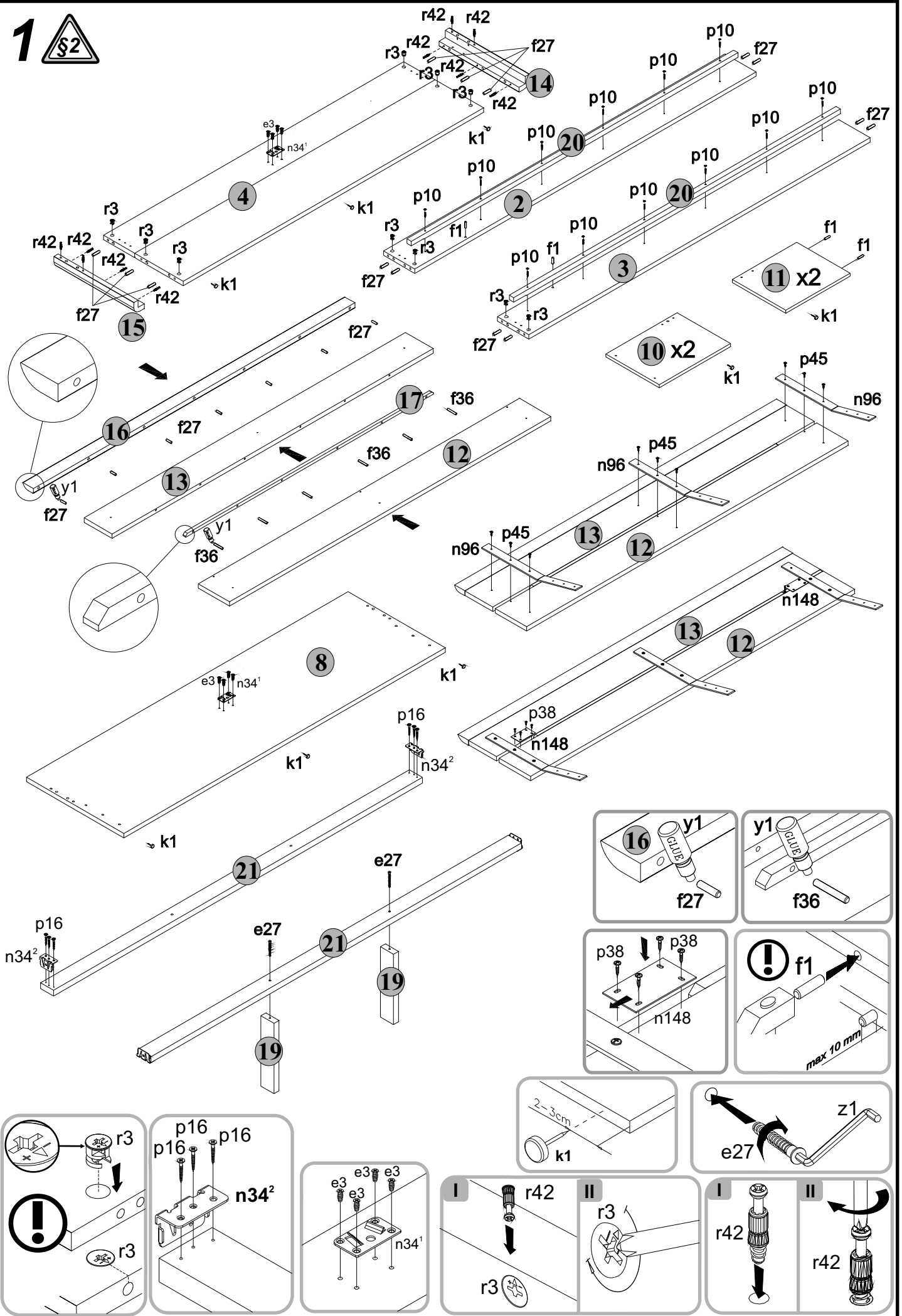

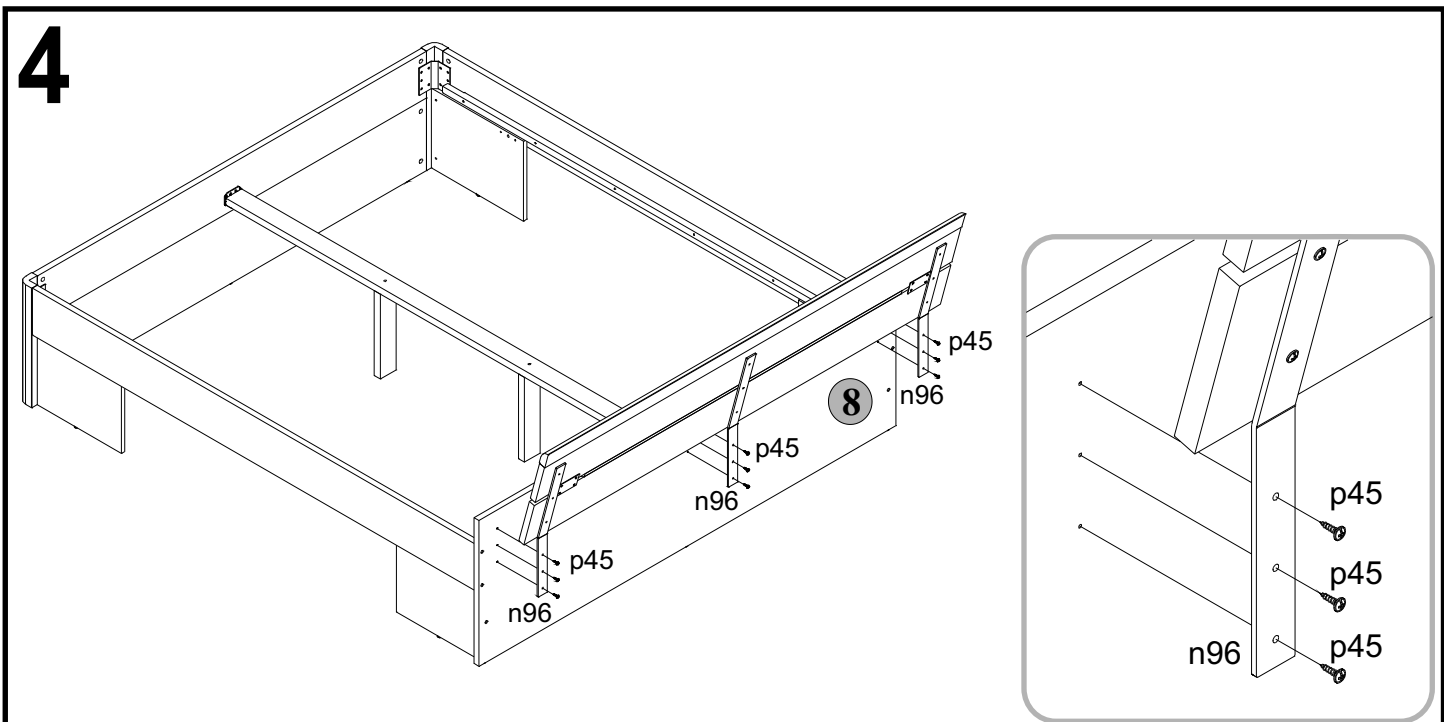
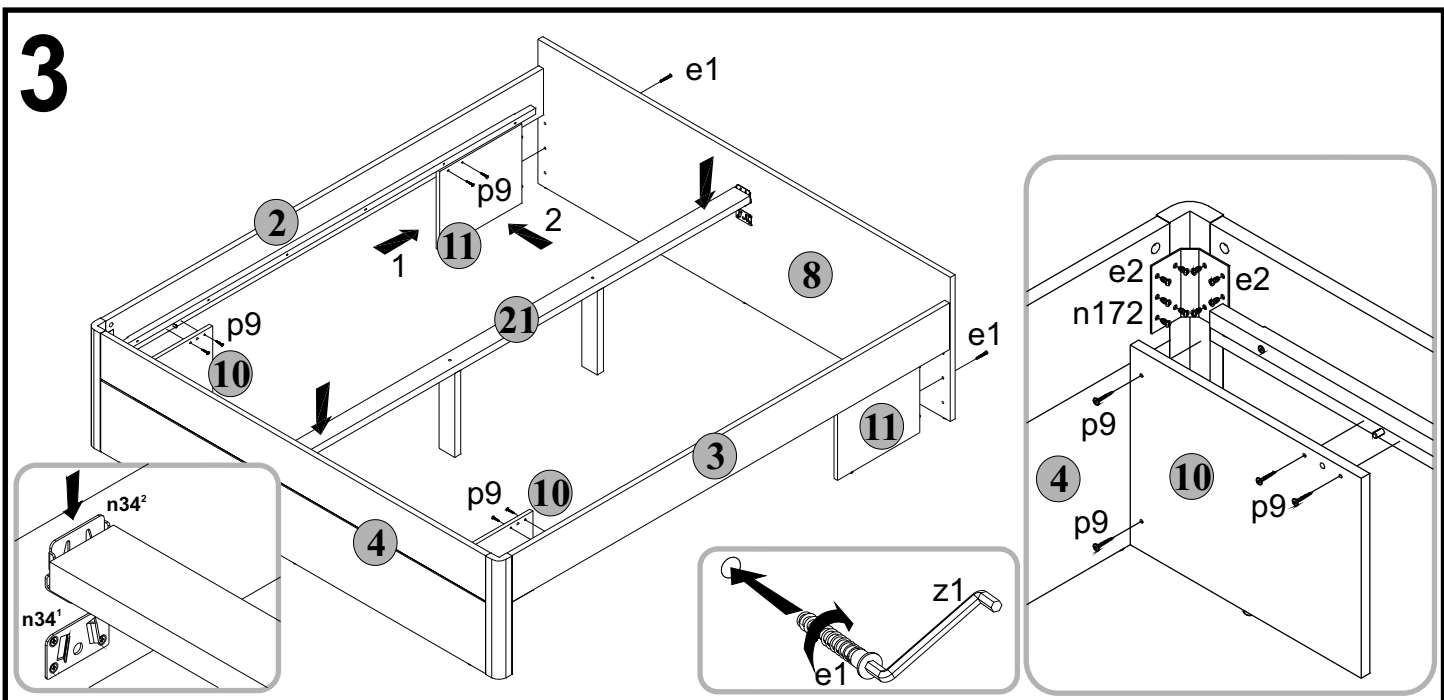
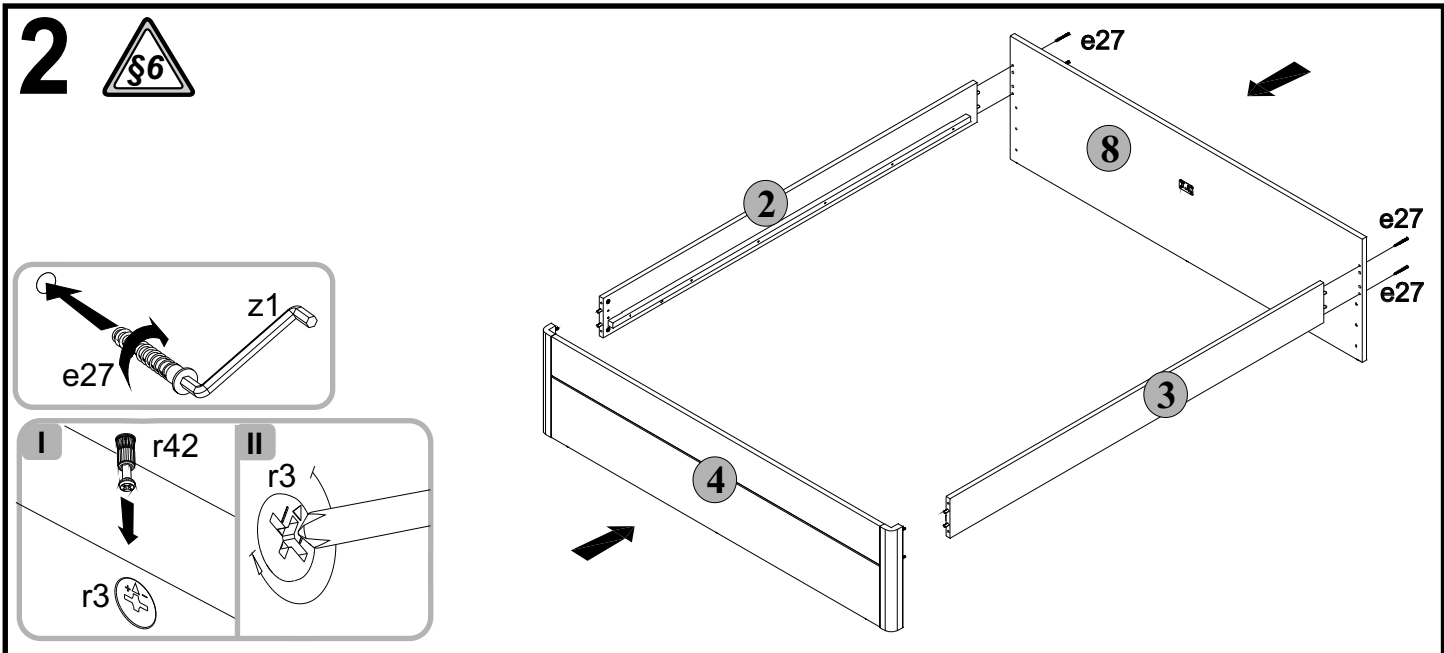

5

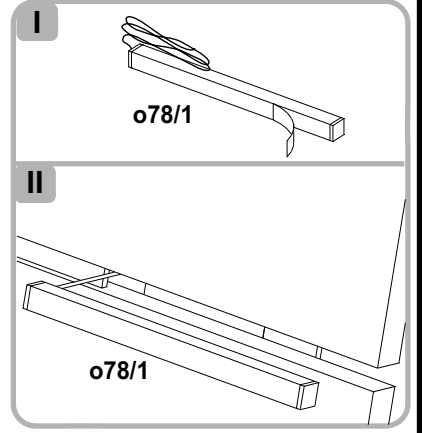
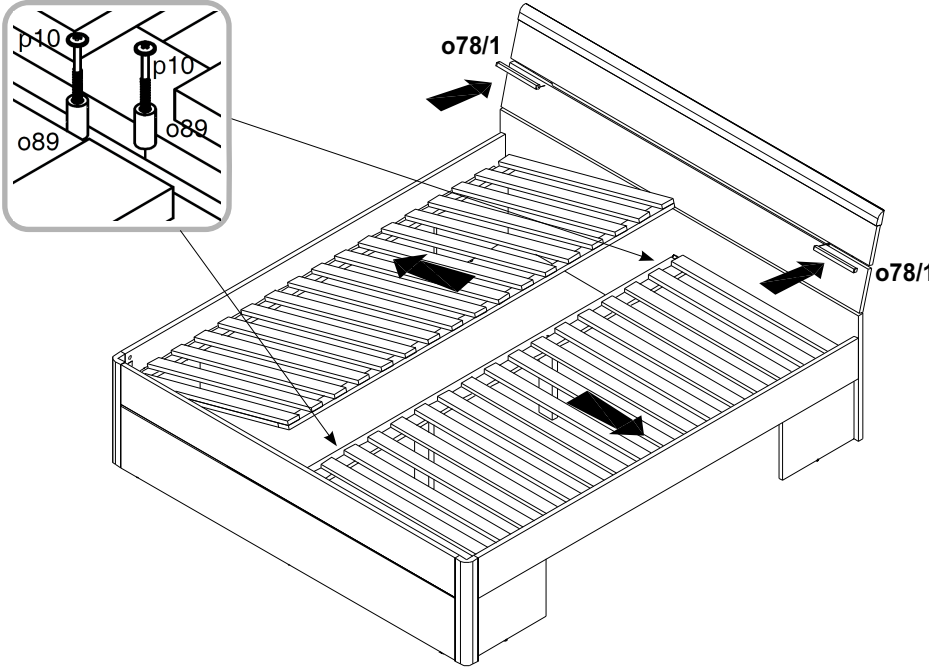

6

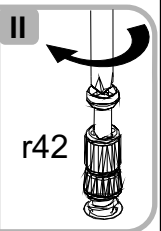
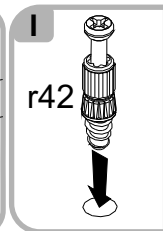
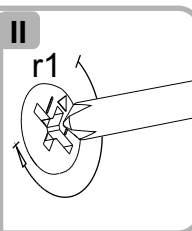
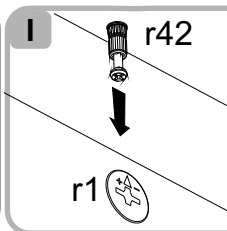
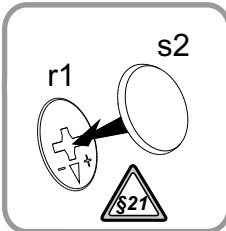
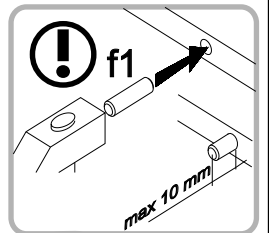
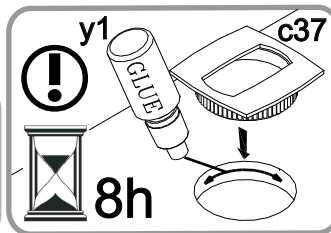
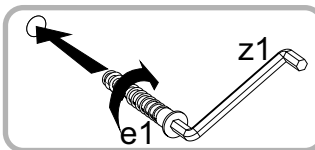
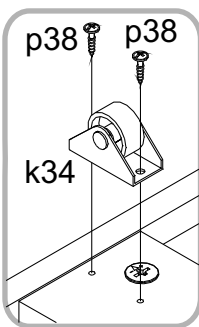
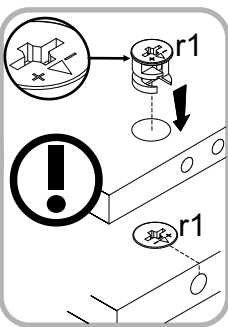
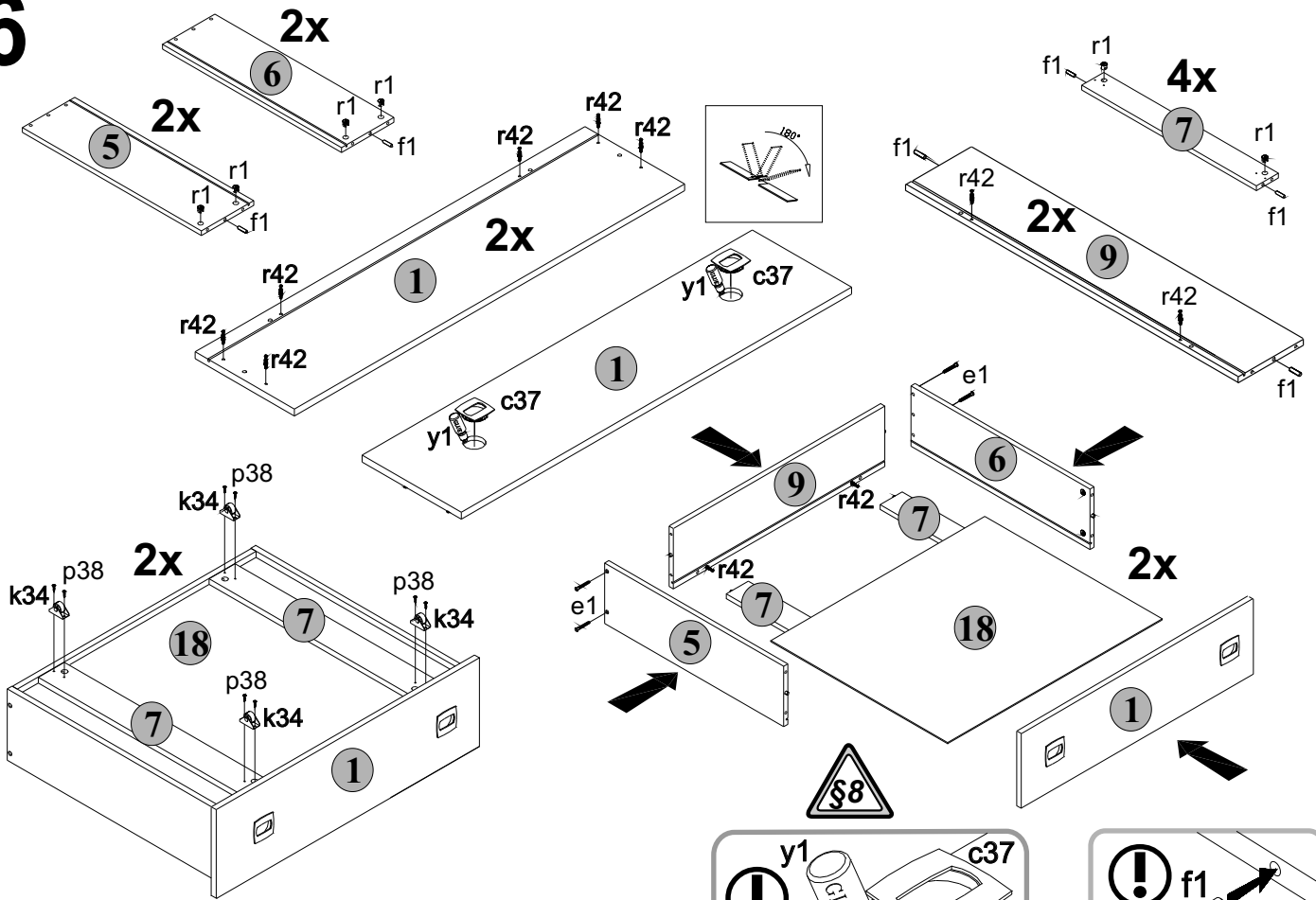

38-092-xx 38-192-xx
 38-202-xx
 38-195-xx

MARS, VENUS, TWIX

L29-KOM3S

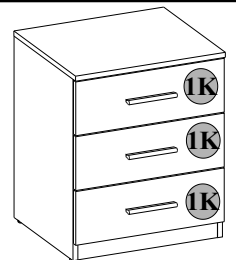
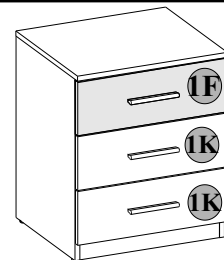
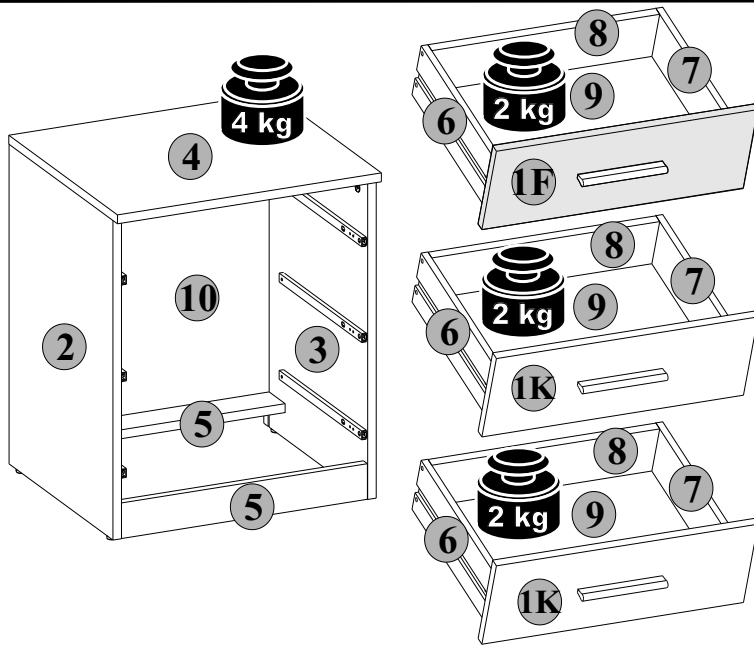

38-092-E4 38-092-A5
 38-092-A9 38-092-87
 38-092-17 38-195-87
 38-092-H1 38-192-E4
 38-092-A7 38-192-A5
 38-092-83
 38-092-37
 38-092-D9
 38-092-F9

38-092-A0
 38-202-17
 38-202-A4



A	B	C	D
1K	L29-001K	458x160x15	1/1
1F	L29-001F	458x160x15	1/1
2	L29-101	540x390x15	1/1
3	L29-102	540x390x15	1/1
4	L21-201	462x408x15	1/1
5	L29-401	431x60x15	1/1
6	MZ1-546	310x100x12	1/1
7	MZ1-547	310x100x12	1/1
8	L21-502	399x100x15	1/1
9	L21-901	410x306x2,5	1/1
10	L29-902	500x441x2,5	1/1

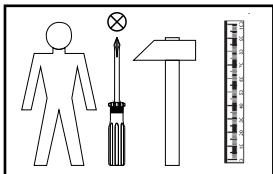

45min

