

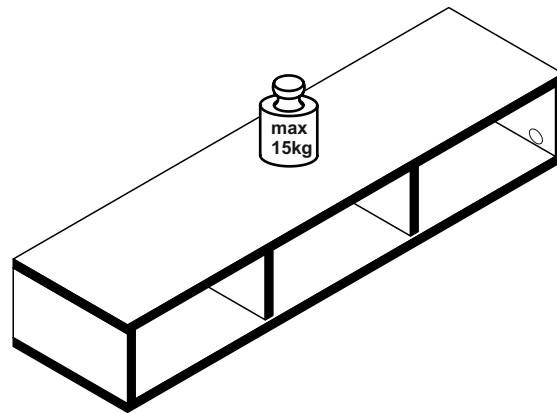

1000051410

**Versandtaschen**  
**Colli 2/2**

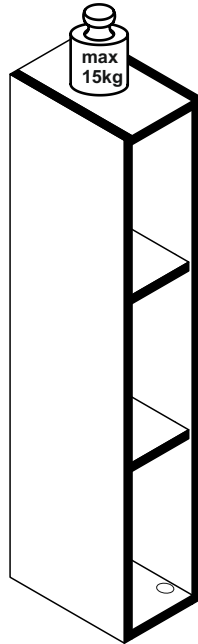

Artikel.-Nr.:

Montageanleitung.-Nr.:

**0771-HR\_00-120 MA1-00001**

REPC-Nr.:	Service • Assistenza • Dienstverlening • Serwis Servis • Szerviz • Сервисная служба			

## Beutel 0771-HR\_00-120 0-11

B02-10		B02-20		B02-103		B01-177-70		B01-188	
14x		14x		8x	8x30	2x	5x70	6x	4,0x15
B05-01		B05-20		B05-130		B08-70		B01-174	
2x		8x		2x		6x	Ø8	4x	4,5x50
B08-90		B08-91							
2x		2x							



▶ SCAN ME

## Beutel BT1-00007

B05-260		B05-265	
1x	by Musterring	1x	by Musterring Pflegeanweisung

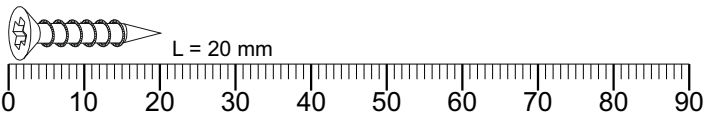

## Colli 1/1

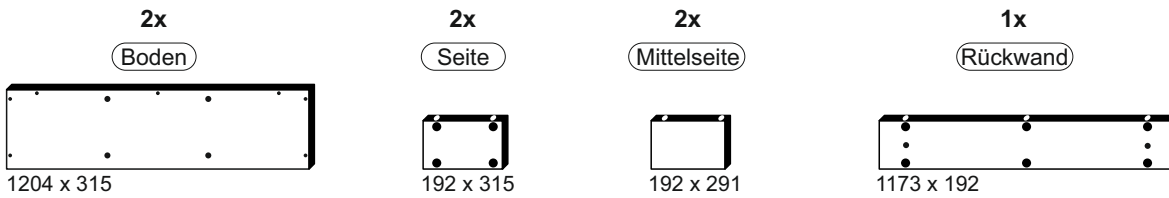

# CHICAGO

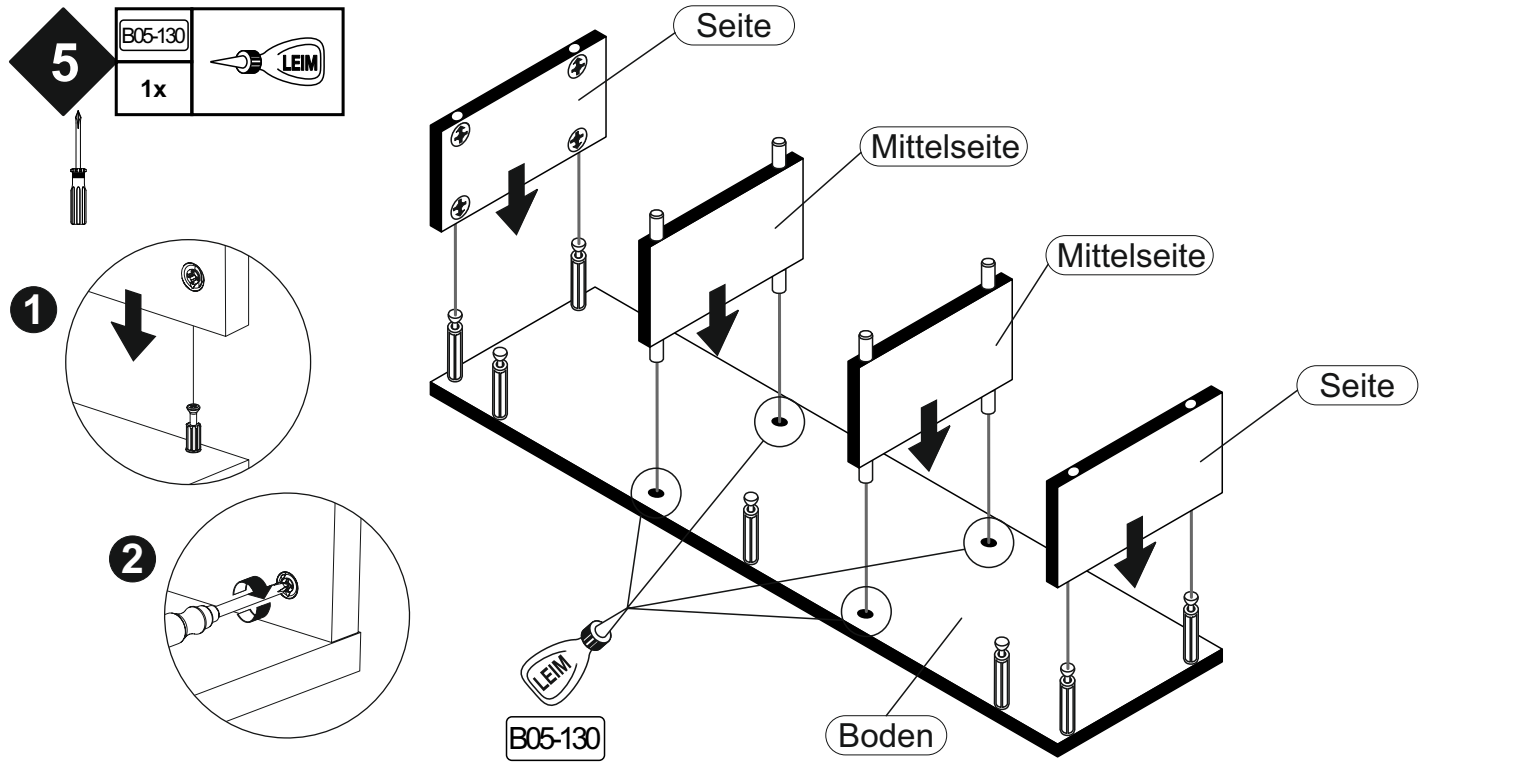
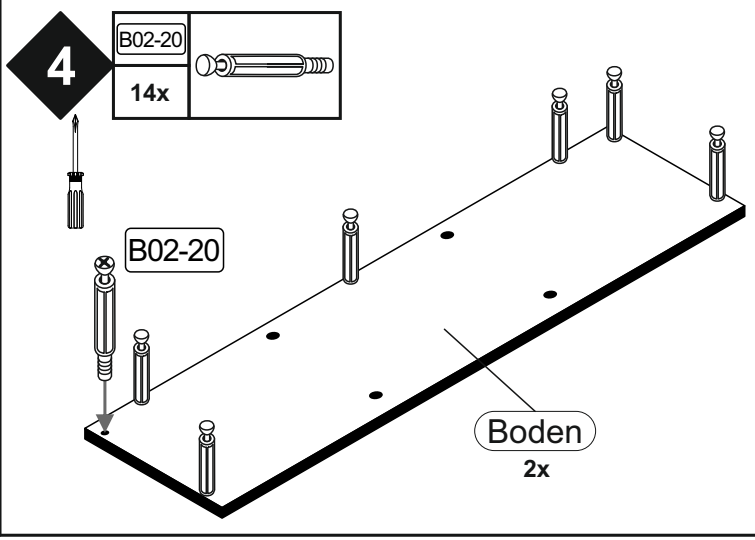
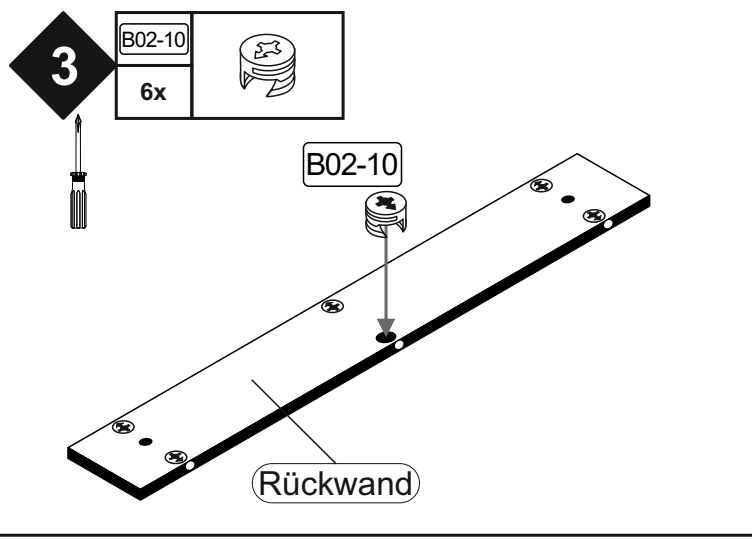
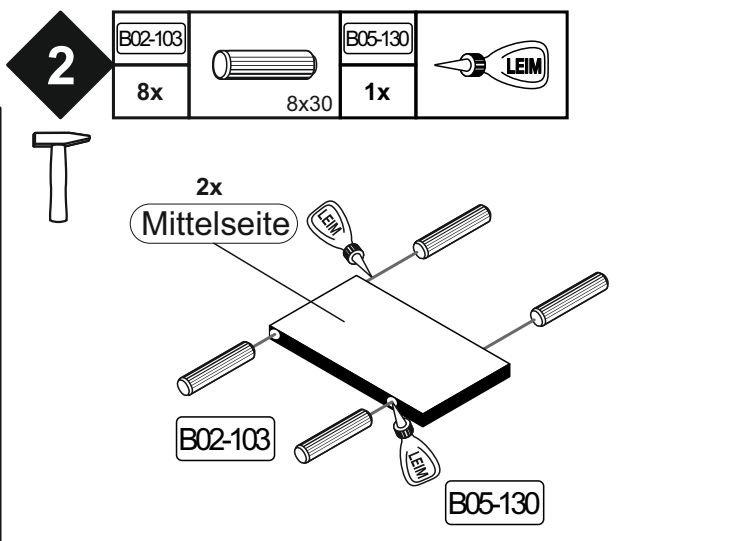
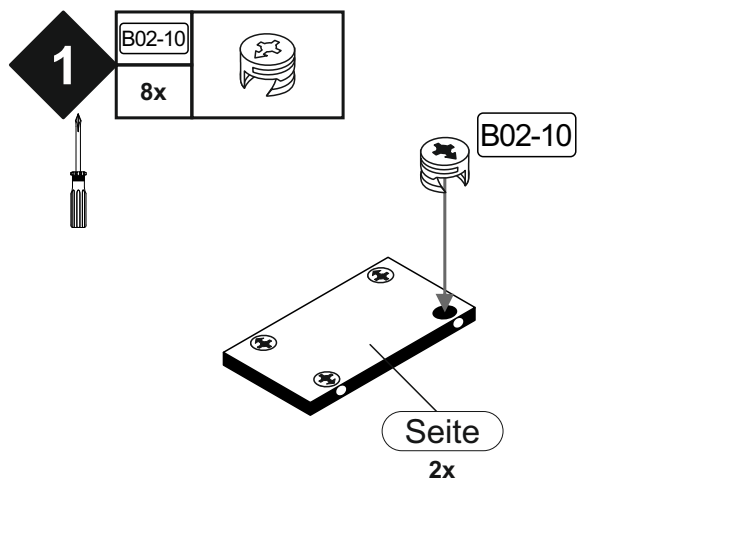

# CHICAGO

6

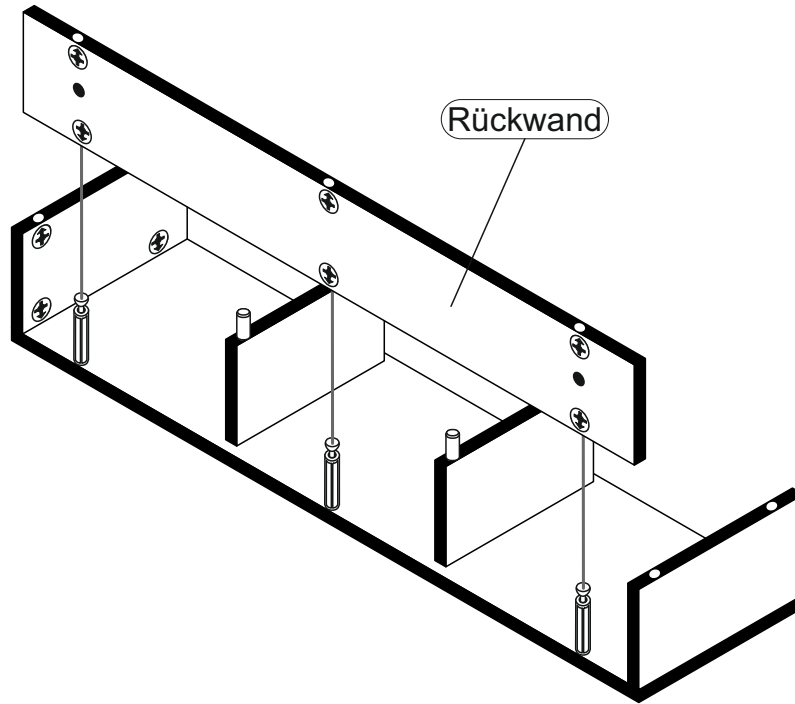

7



B05-20		B05-130	
8x		1x	LEIM

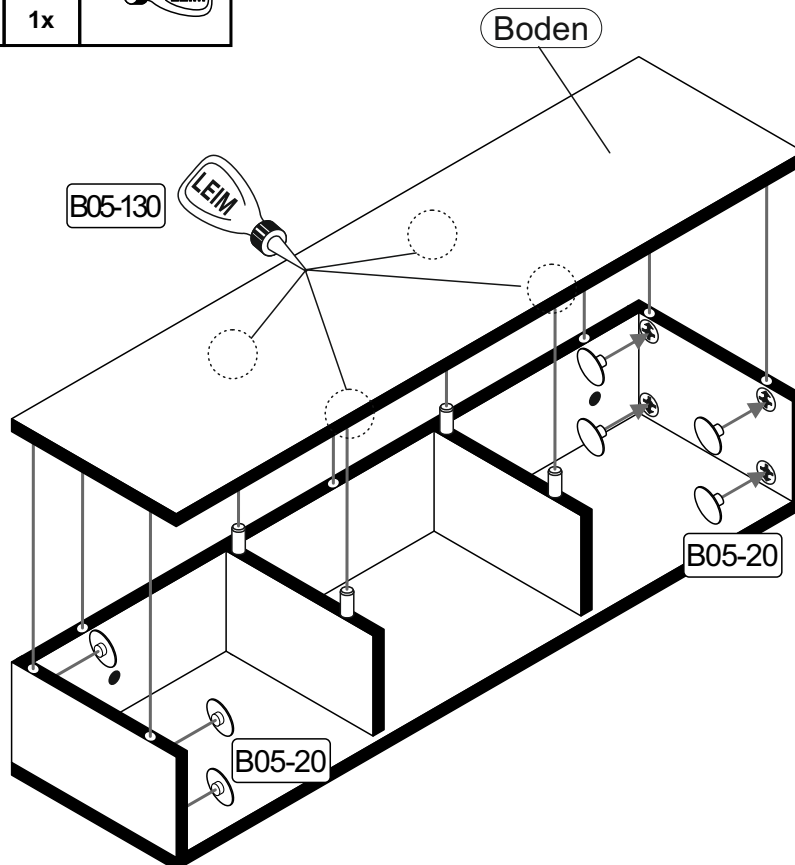

8

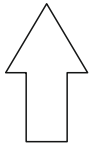

# Schablone zum aufhängen

( hierzu die Ecken des Blattes in die Ecke zwischen Seite und Oberplatte anlegen und mit einem Dorn die Löcher vorstechen. )

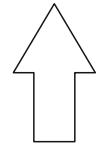

vertikale  
Aufhängung

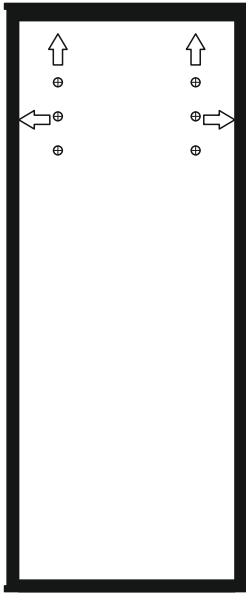

horizontale  
Aufhängung

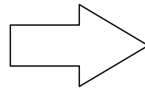
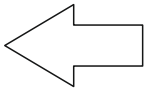

B01-188		B08-90	
6x	4,0x15	2x	

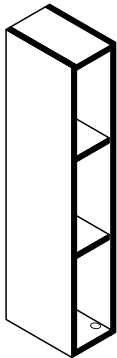

vertikale  
Aufhängung

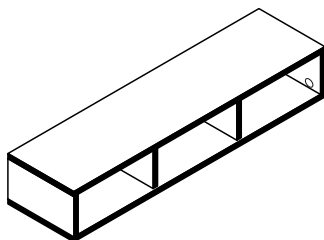
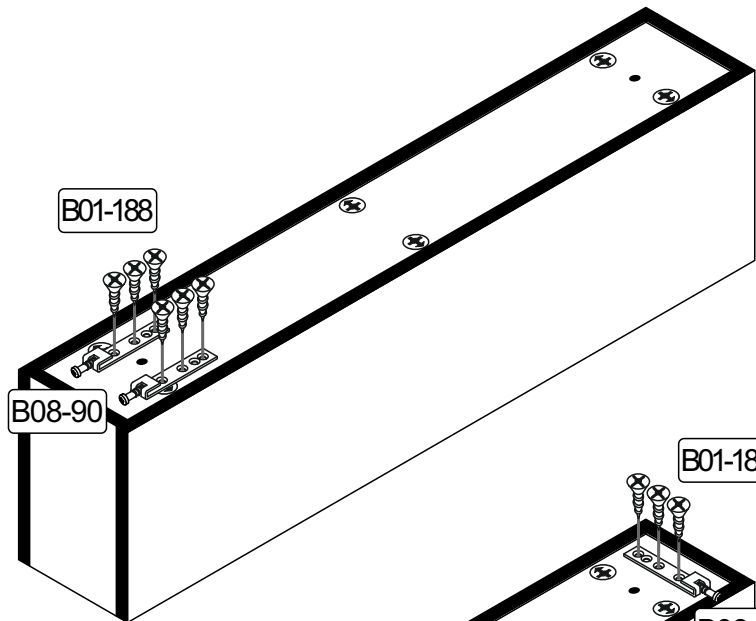

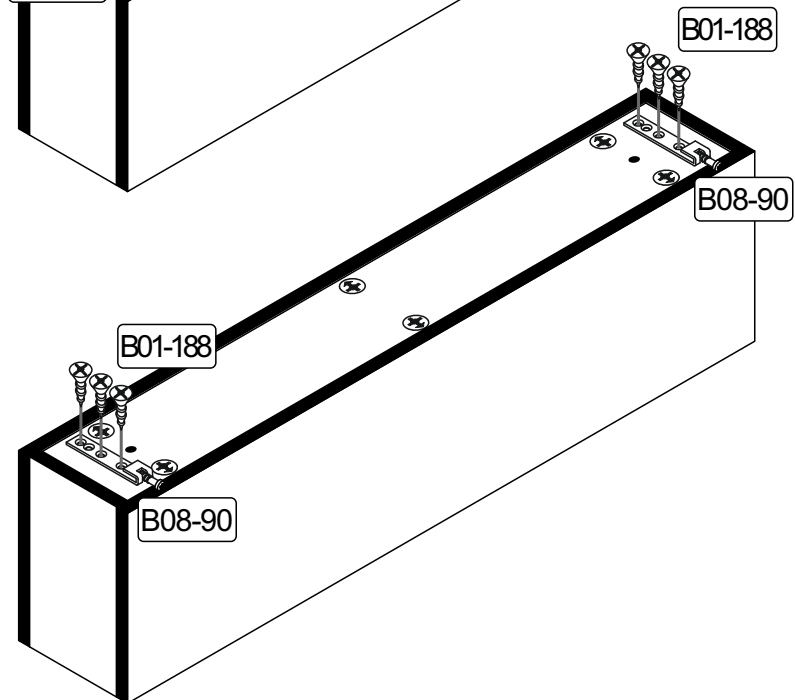

horizontale  
Aufhängung



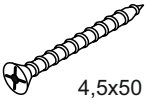

9

B01-174		B08-91		B08-70	
4x	4,5x50	2x		4x	Ø8

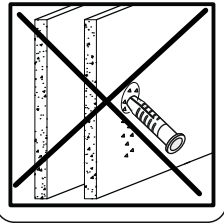
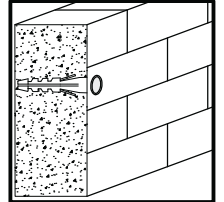
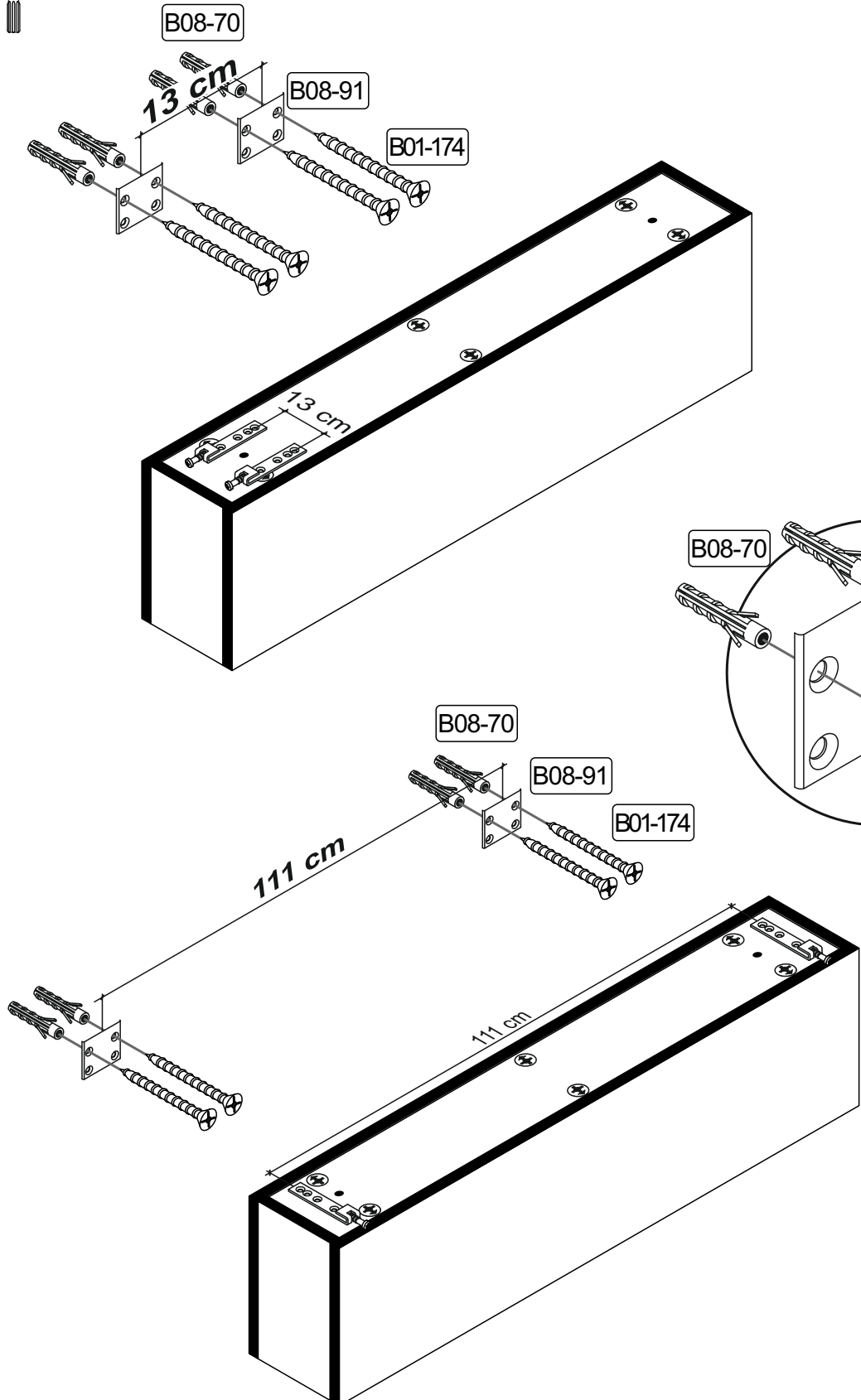

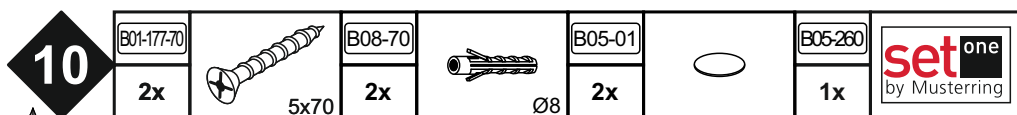

▶ SCAN ME

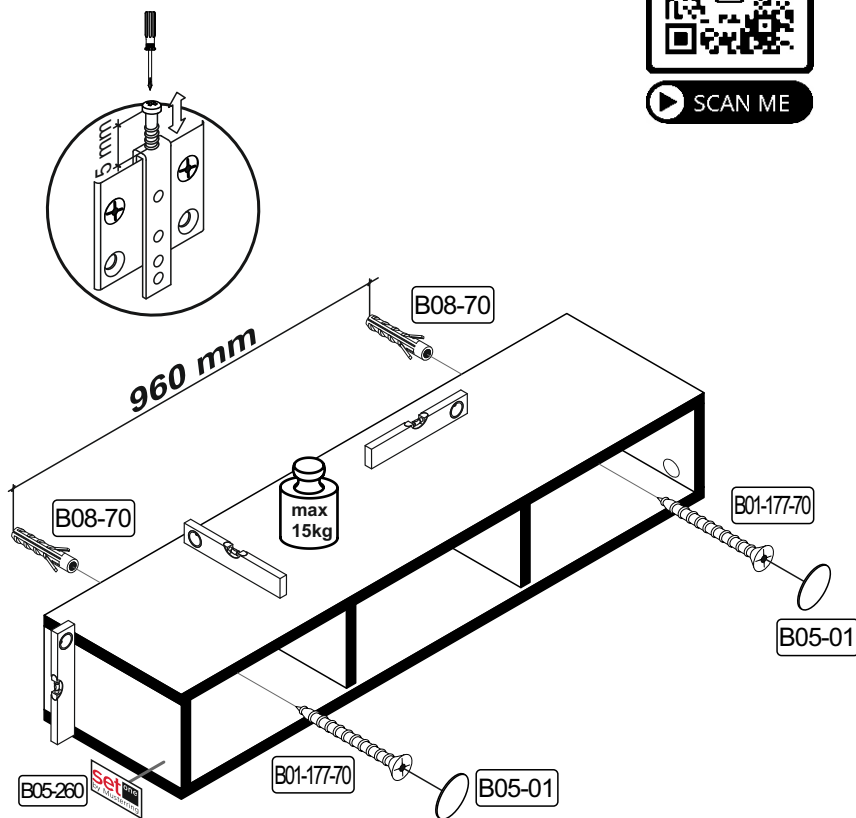
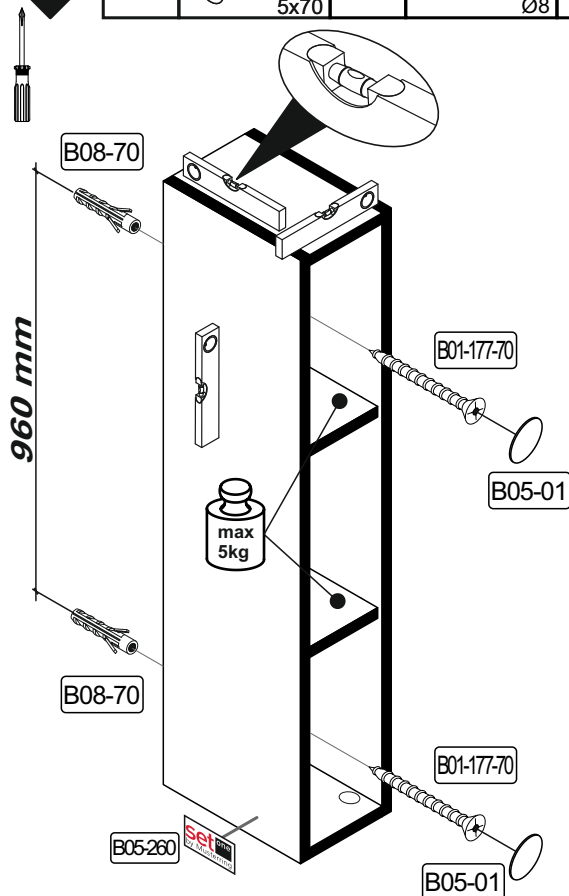

<b>Achtung • Attention • Attenzione • Opgelet • Uwaga • Pozor •                      Figyelem • Atenție • Dikkat • Внимание</b>	
<b>(D)</b>	Wandbefestigung dient als Kippschutz - unbedingt anbringen! Bei einigen Wandtypen kann ein Spezialdübel erforderlich sein!
<b>(GB)</b>	The wall fastening serves to prevent tipping - be absolutely sure to mount it! For certain wall types, a special wall plug may be necessary!
<b>(FR)</b>	La fixation murale sert de protection contre le basculement – à installer impérativement ! Pour certains types de murs il faut des chevilles spéciales !
<b>(TR)</b>	Duvardaki sabitleme, devrilmeye karşı bir emniyet tedbiridir ve mutlaka monte edilmelidir! Bazı duvar tiplerinde bunun için özel bir dübel gerekli olabilir!
<b>(IT)</b>	Il fissaggio alla parete serve da protezione anti-ribaltamento – attaccarla assolutamente! Per alcune strutture di parete può essere necessario un tassello speciale!
<b>(NL)</b>	Bevestiging aan de muur dient als kantelbescherming – zeker en vast bevestigen! Bij enkele muurtypes is een speciale plug misschien vereist!
<b>(RU)</b>	Обязательно установите крепление на стене во избежание опрокидывания! Для некоторых типов стен может потребоваться специальный дюбель!
<b>(CZ)</b>	Montáž na stěnu slouží jako ochrana proti převrnutí – bezpodmínečně umístěte! U některých typů stěn může být zapotřebí speciální hmoždinka!
<b>(HU)</b>	A terméket a falhoz kel rögzíteni, különben az felborulhat! Egyes faltípusoknál speciális tiplit kell használni!
<b>(RO)</b>	Sistemul de fixare la perete servește ca protecție la răsturnare - de montat obligatoriu! Pentru unele tipuri de perți este posibil să fie necesar un diblu special!
<b>(PL)</b>	Mocowanie do ściany jest jednocześnie zabezpieczeniem przed przewróceniem – koniecznie zamontować! Do niektórych rodzajów ścian koniecznie zastosować specjalne kołki mocujące.
<b>(SK)</b>	Upevnenie na stenu slúži ako ochrana proti prevráteniu – bezpodmienečne použite! Pre niektoré druhy stien môže byť potrebná špeciálna hmoždinka!