



(D) Videounterstützte
Montageanleitung

(TR) Video destekli kurulum
talimatları

(RU) инструкция по
монтажу с помощью
видеосигнала

(RO) Instrucțiuni de instalare
acceptate video

(GB) Video-assisted
assembly instructions

(IT) Istruzioni di montaggio
video-assistite

(CZ) Instalační pokyny
podporované videem

(PL) Instrukcje montażu
wspomagane sygnałem
wizyjnym

(FR) Instructions de montage
assistées par vidéo

(NL) Video-ondersteunde
montage-instructies

(HU) Video-támogatott
telepítési utasítások

(SK) Inštalčné pokyny
podporované videom

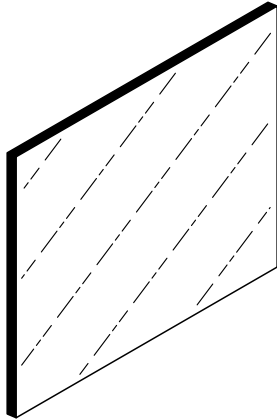
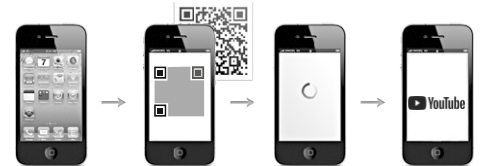

Art.-Nr.: **0900-SP_60x60**
Spiegel

REPC-Nr.:



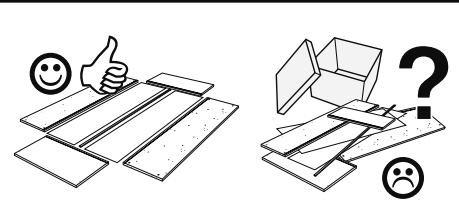
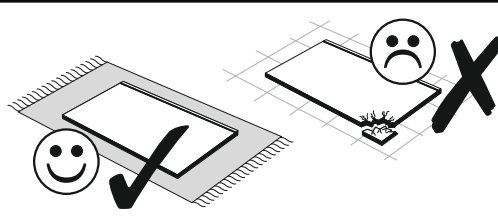
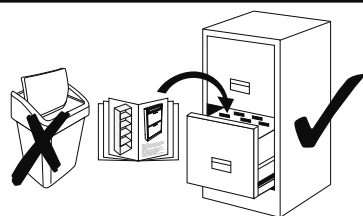
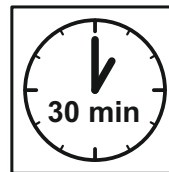
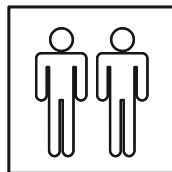
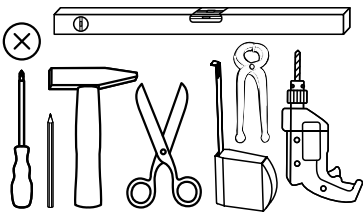

Service • Assistenza • Dienstverlening • Serwis
Servis • Szerviz • Сервисная служба



SCAN ME

Das Ersatzteil-Anforderungsformular finden Sie auf
The replacement parts requisition form you find on
<https://www.maeusbacher.de/ersatzteile/>

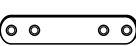
BT1-00216 Colli 1/1

B01-80		B01-122			
8x	3,5x13	2x	4x13		
B02-143		B08-30		B08-70	
2x		2x	5,5x55	2x	Ø8



▶ SCAN ME

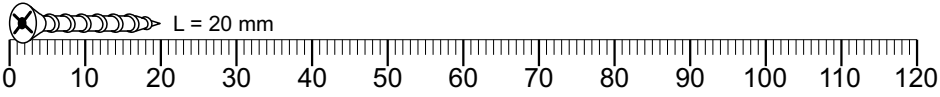

Colli 1/1

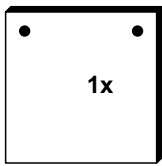

599 x 599

FTx-000394

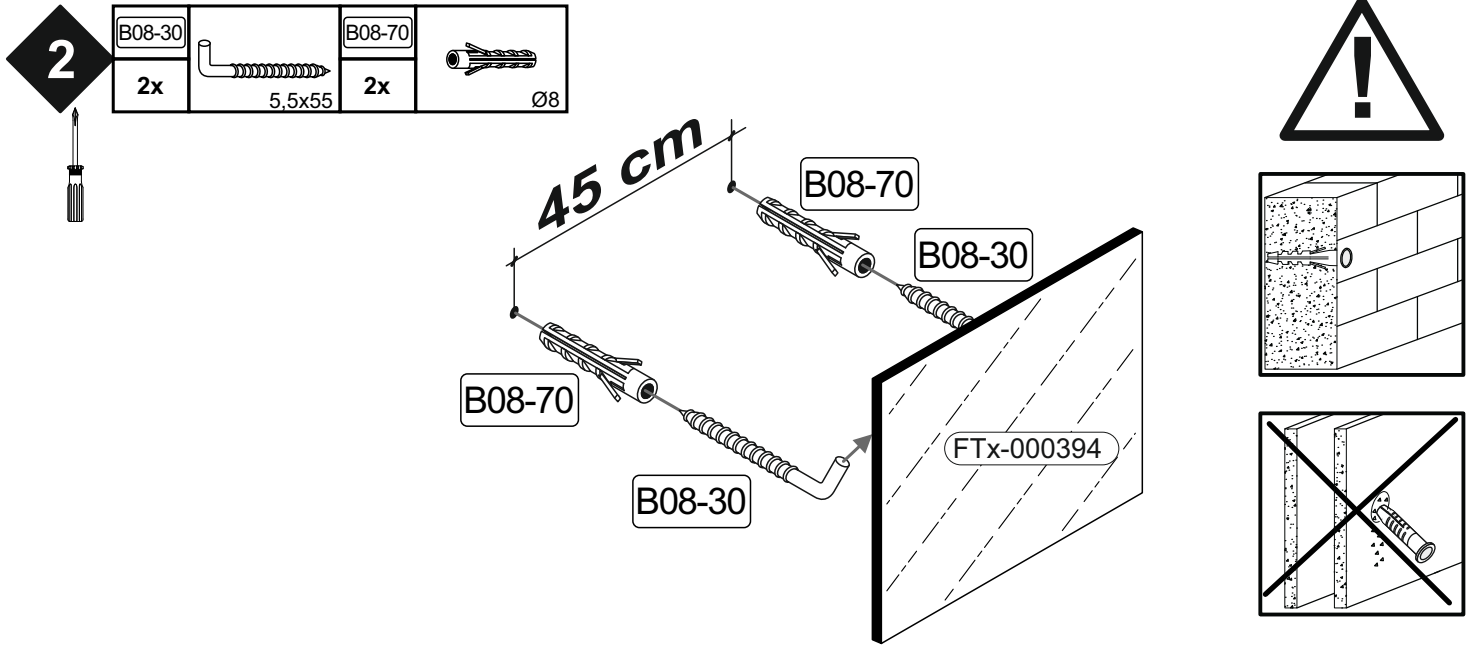
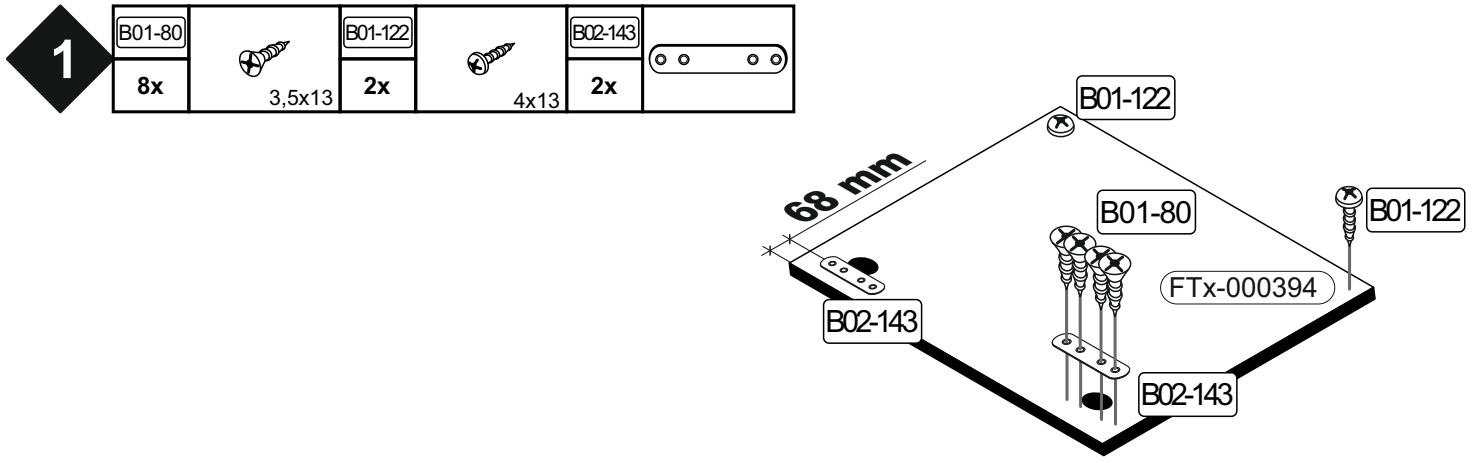

Achtung • Attention • Attenzione • Opgelet • Uwaga • Pozor • Figelem • Atenție • Dikkat • Внимание	
(D)	Wandbefestigung dient als Kippschutz - unbedingt anbringen! Bei einigen Wandtypen kann ein Spezialdübel erforderlich sein!
(GB)	The wall fastening serves to prevent tipping - be absolutely sure to mount it! For certain wall types, a special wall plug may be necessary!
(FR)	La fixation murale sert de protection contre le basculement – à installer impérativement ! Pour certains types de murs il faut des chevilles spéciales !
(TR)	Duvardaki sabitleme, devrilmeye karşı bir emniyet tedbiridir ve mutlaka monte edilmelidir! Bazı duvar tiplerinde bunun için özel bir dübel gerekli olabilir!
(IT)	Il fissaggio alla parete serve da protezione anti-ribaltamento – attaccarla assolutamente! Per alcune strutture di parete può essere necessario un tassello speciale!
(NL)	Bevestiging aan de muur dient als kantelbescherming – zeker en vast bevestigen! Bij enkele muurtypes is een speciale plug misschien vereist!
(RU)	Обязательно установите крепление на стене во избежание опрокидывания! Для некоторых типов стен может потребоваться специальный дюбель!
(CZ)	Montáž na stěnu slouží jako ochrana proti převrnutí – bezpodmínečně umístěte! U některých typů stěn může být zapotřebí speciální hmoždinka!
(HU)	A terméket a falhoz kel rögzíteni, különben az felborulhat! Egyes faltípusoknál speciális tiplit kell használni!
(RO)	Sistemul de fixare la perete servește ca protecție la răsturnare - de montat obligatoriu! Pentru unele tipuri de pereți este posibil să fie necesar un diblu special!
(PL)	Mocowanie do ściany jest jednocześnie zabezpieczeniem przed przewróceniem – koniecznie zamontować! Do niektórych rodzajów ścian koniecznie zastosować specjalne kołki mocujące.
(SK)	Upevnenie na stenu slúži ako ochrana proti prevráteniu – bezpodmienečne použiť! Pre niektoré druhy stien môže byť potrebná špeciálna hmoždinka!