

**D** Montageanleitung

**GB** Assembly instructions

**NL** Handleiding voor de montage

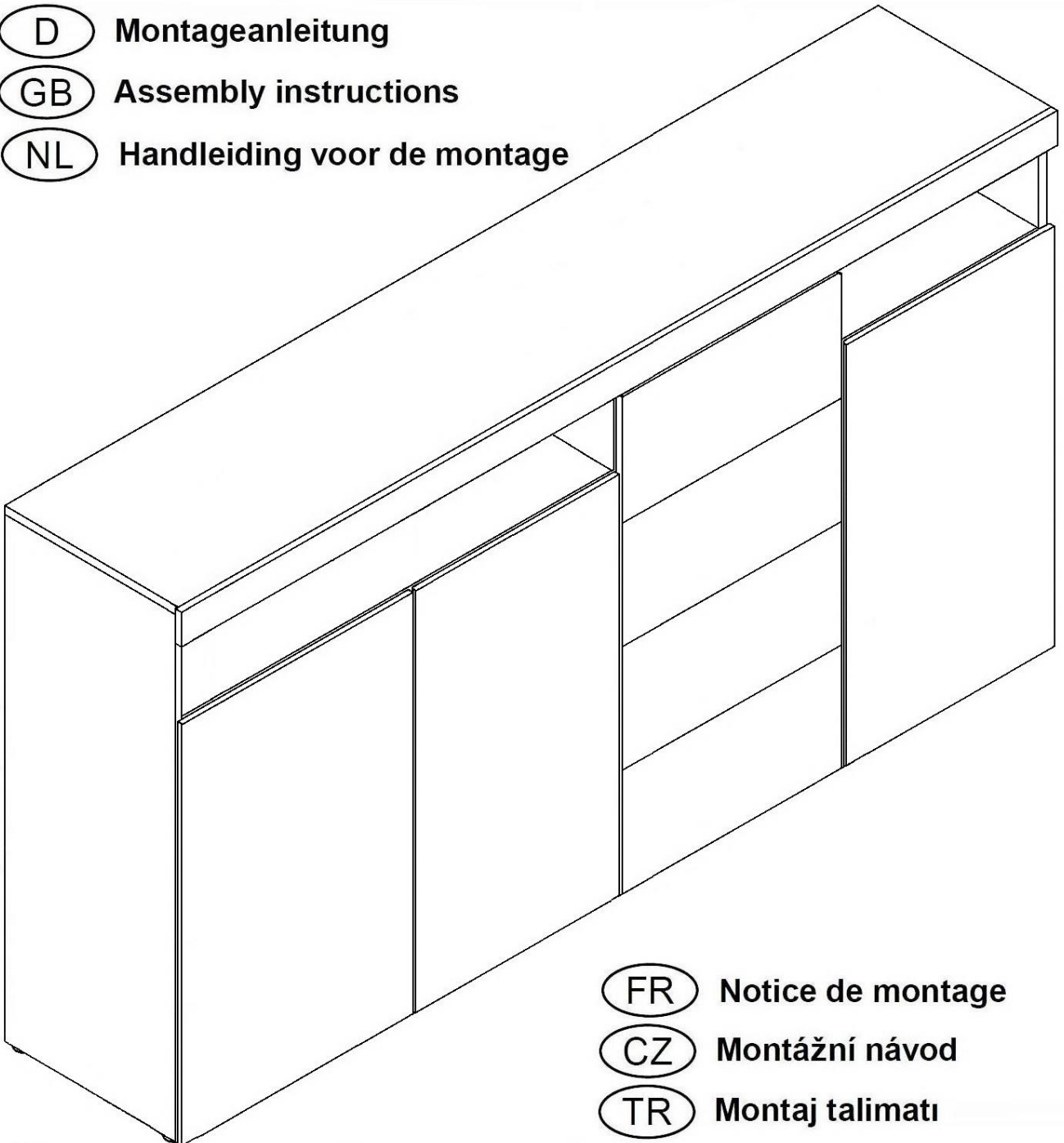

**FR** Notice de montage

**CZ** Montážní návod

**TR** Montaj talimatı

**IT** Istruzioni di montaggio

**SK** Návod na montáž

**RU** Инструкция по монтажу

**HU** Szerelési útmutató

**PL** Instrukcja montażu

**RO** Instrucțiuni de montaj

**Service • Assistenza • Dienstverlening • Serwis  
Servis • Szerviz • Сервисная служба**

Name • Nom • Nome • Naam •  
Nazwa • Jméno • Názov • Név •  
Denumire • Ísim • Название

Nr. • No. • N° • Номер • Č • Sz

Typ • Type • Tip • Típus • Tipo •  
Тип

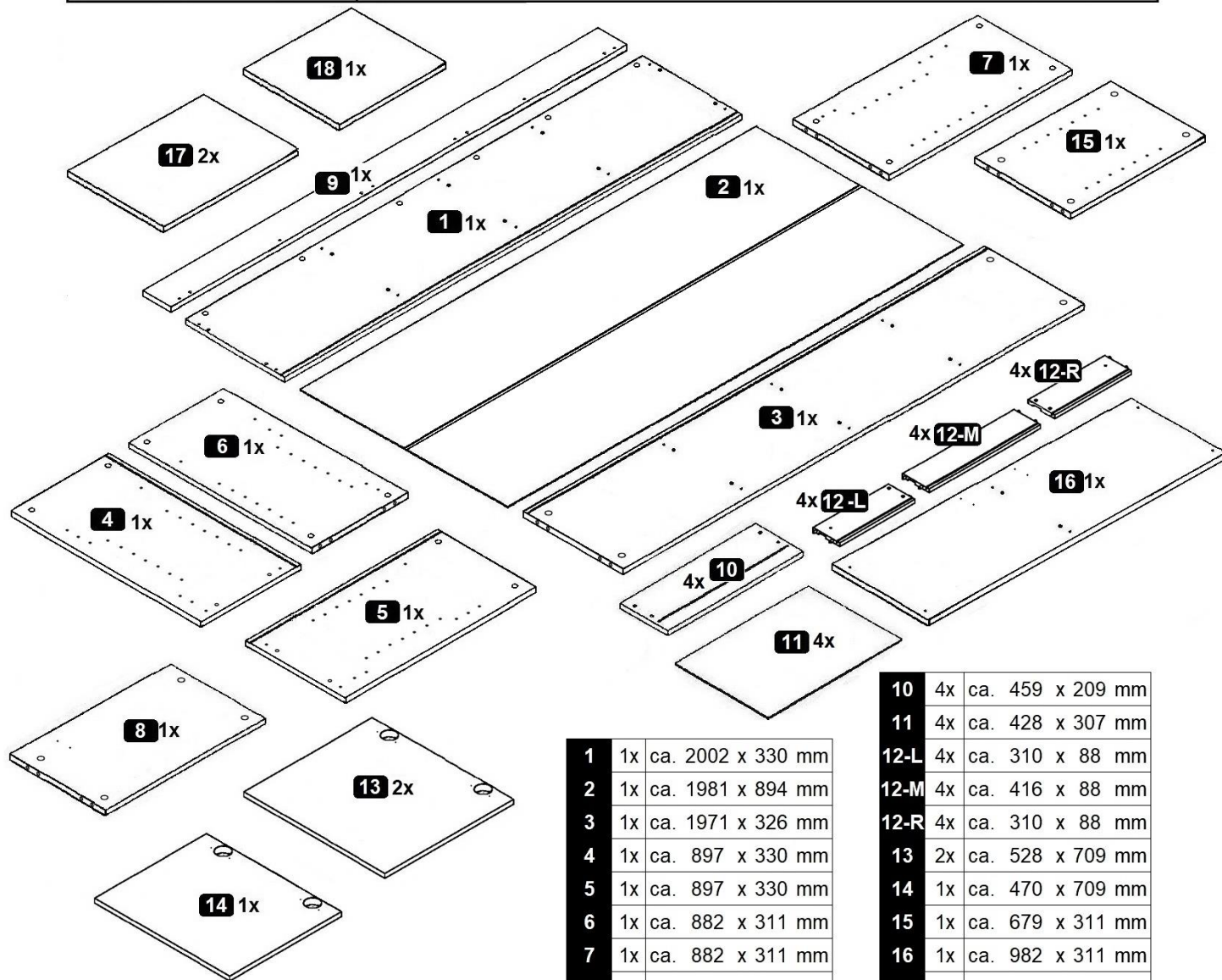
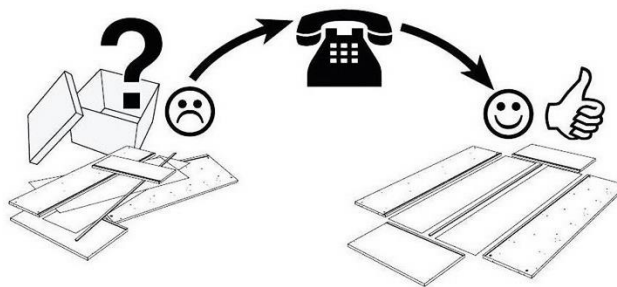
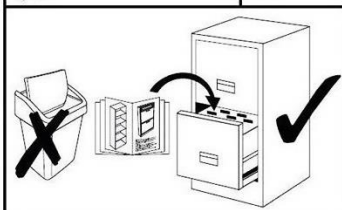

1	1x	ca. 2002 x 330 mm
2	1x	ca. 1981 x 894 mm
3	1x	ca. 1971 x 326 mm
4	1x	ca. 897 x 330 mm
5	1x	ca. 897 x 330 mm
6	1x	ca. 882 x 311 mm
7	1x	ca. 882 x 311 mm
8	1x	ca. 507 x 311 mm
9	1x	ca. 2002 x 60 mm

10	4x	ca. 459 x 209 mm
11	4x	ca. 428 x 307 mm
12-L	4x	ca. 310 x 88 mm
12-M	4x	ca. 416 x 88 mm
12-R	4x	ca. 310 x 88 mm
13	2x	ca. 528 x 709 mm
14	1x	ca. 470 x 709 mm
15	1x	ca. 679 x 311 mm
16	1x	ca. 982 x 311 mm
17	2x	ca. 507 x 300 mm
18	1x	ca. 459 x 300 mm

<b>A</b> 8,0 x 30 mm 24x	<b>B</b> 26x	<b>C</b> 26x	<b>D</b> 3,9x9,5mm 7x	<b>E</b> h=2 6x	<b>F</b> Ø35 Kr.0 3,5x13 mm 4x	<b>G</b> 1x
<b>H</b> 4,0 x 20 mm 7x	<b>I</b> 7x	<b>J</b> 2,7 x 20 mm 10x	<b>K</b> 6,3 x 13 mm 16x	<b>L</b> 17 x 310 mm 8x	<b>M</b> M4,0 x 9 mm 8x	<b>N</b> Ø35 Kr.8 3,5x13 mm 2x
<b>O</b> 12x	<b>P</b> 8x					



**1**

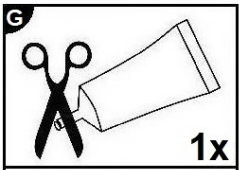
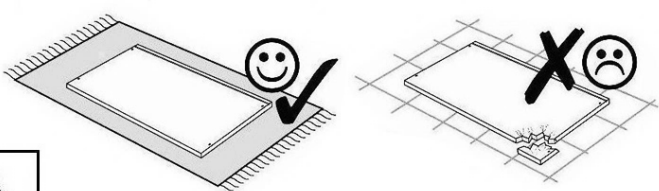

- D Leim
- GB Glue
- FR Colle
- IT Colla
- NL Lijm
- PL Klej
- CZ Lepidlo
- SK Glej
- HU Enyv
- RO Adeziv
- TR Tutkal
- RU Клей

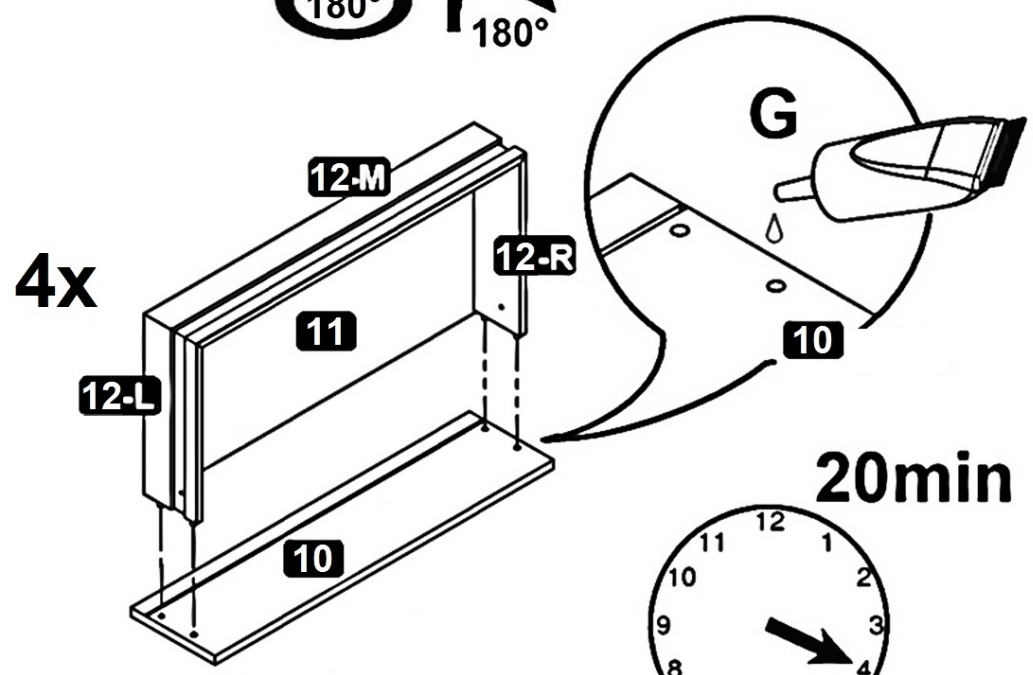
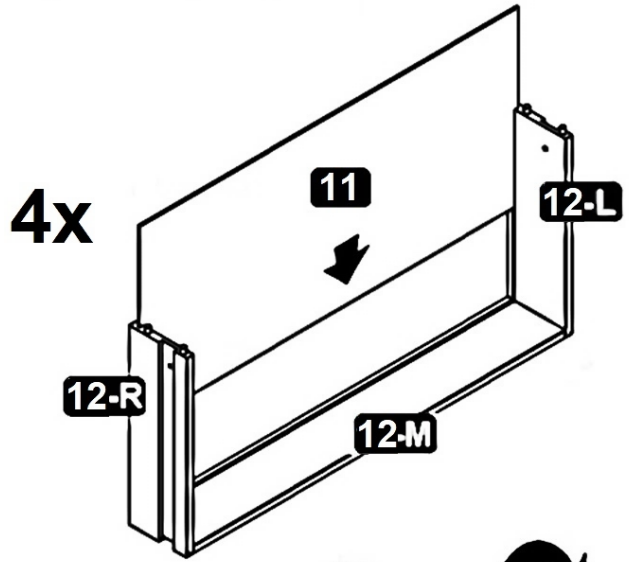
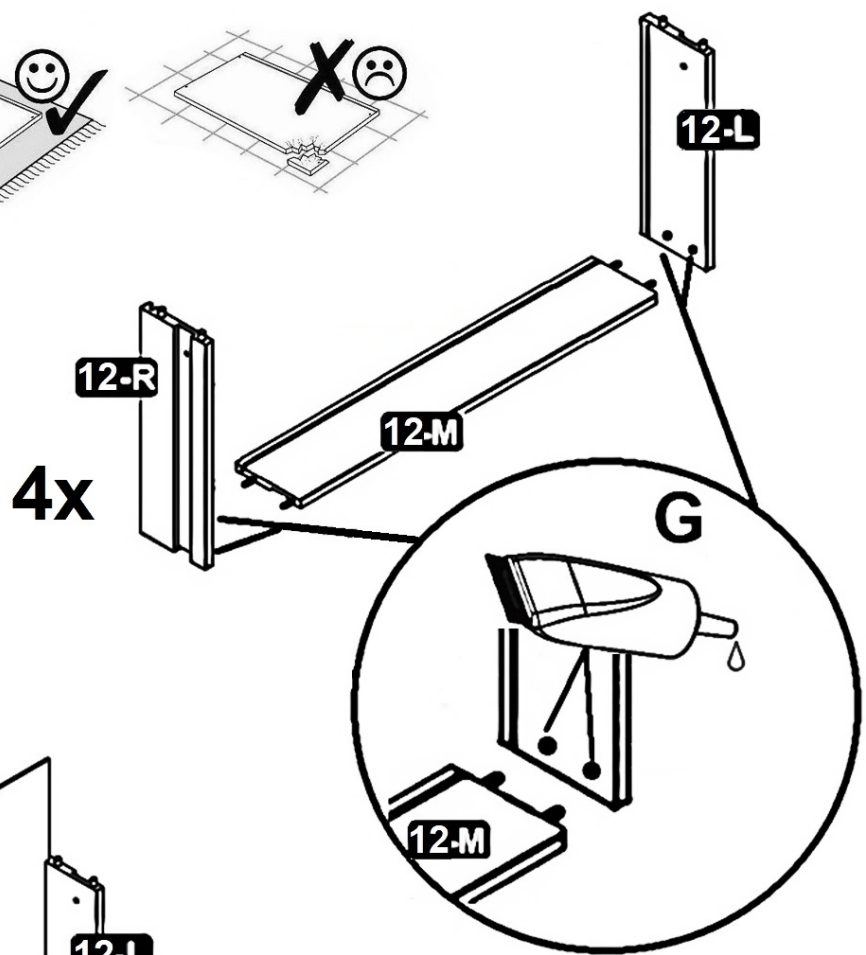

MA1

**2**

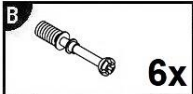
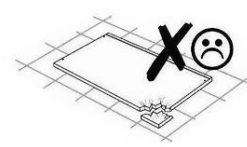
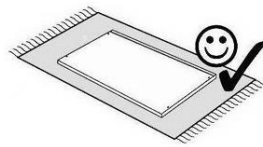
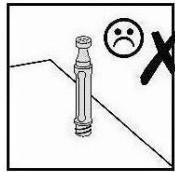
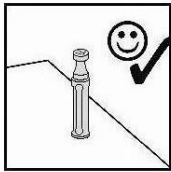

6x

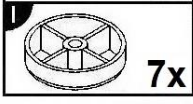

7x

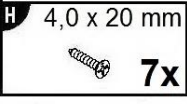

7x

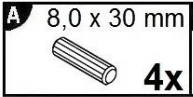

8,0 x 30 mm

4x



4x

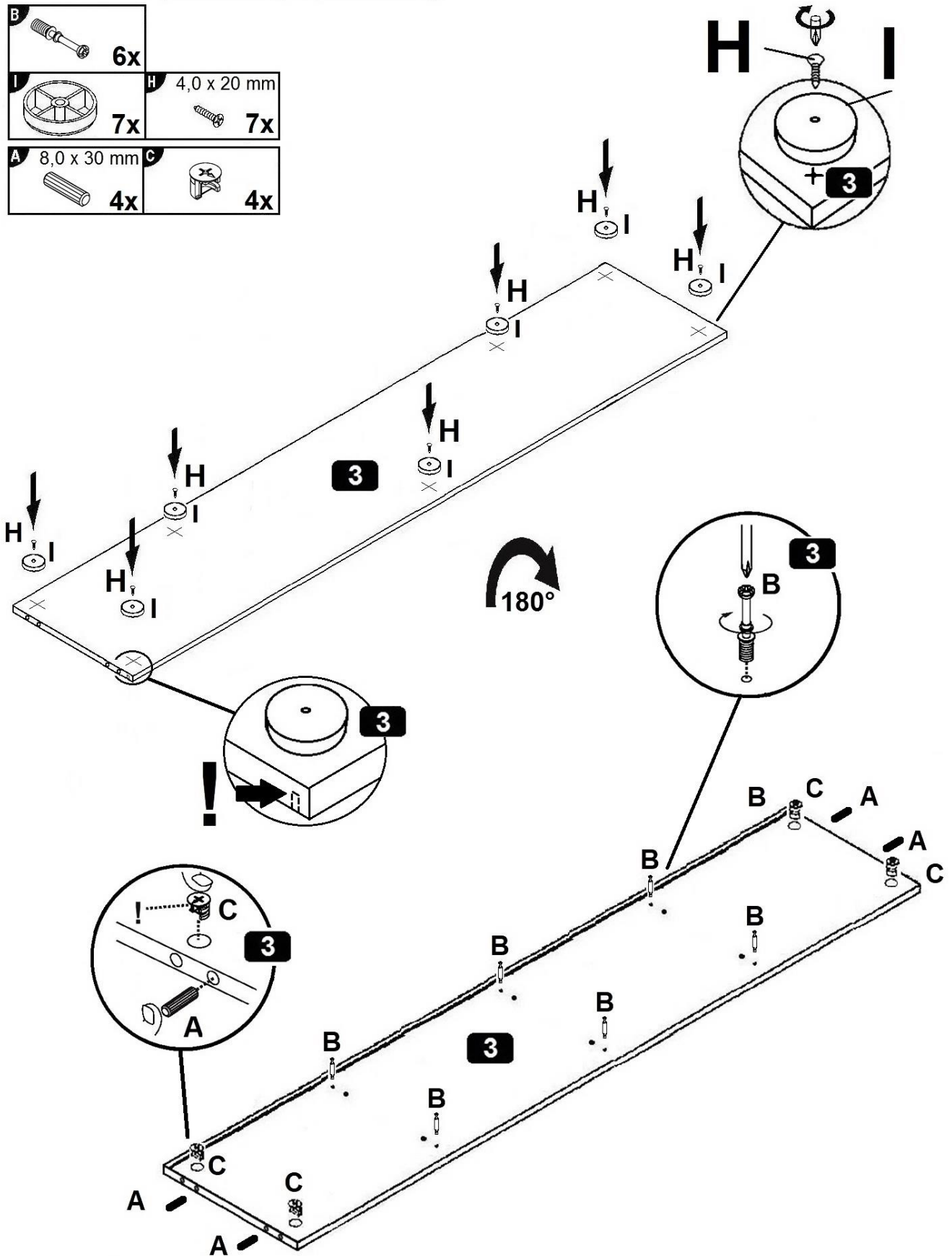

**3**

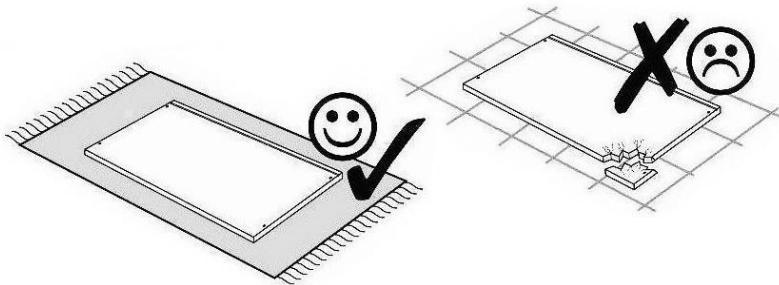
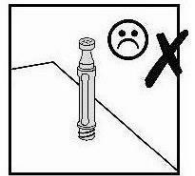
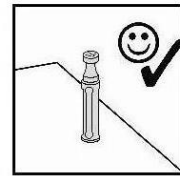
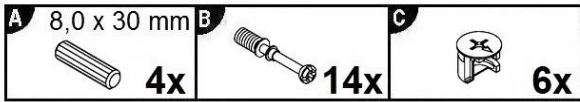

**1.!**

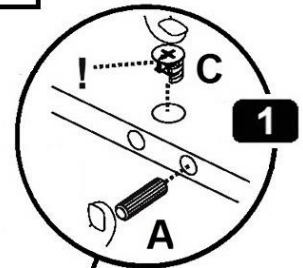

**2.!**

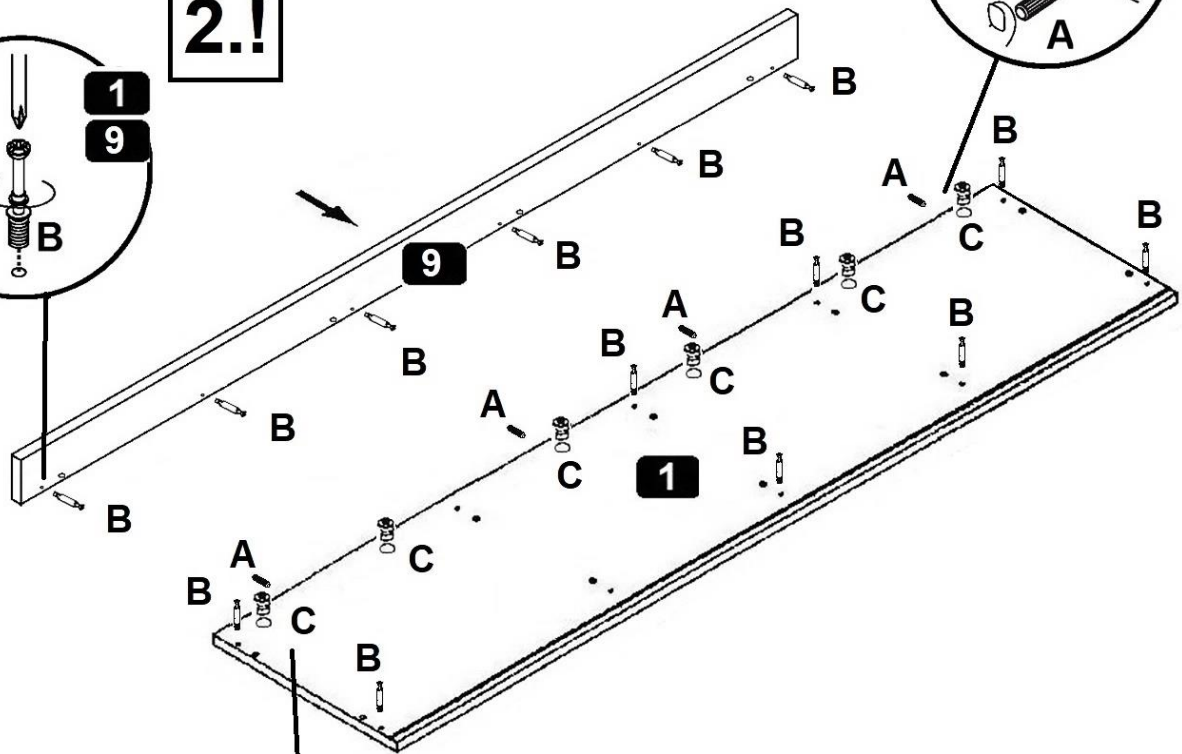
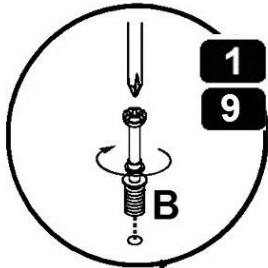

**3.!**

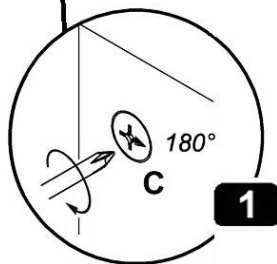

**4**

**A** 8,0 x 30 mm **8x**

**B** **6x**

**C** **8x**

**D** 3,9x9,5mm **3x**  
h=2 **4x**

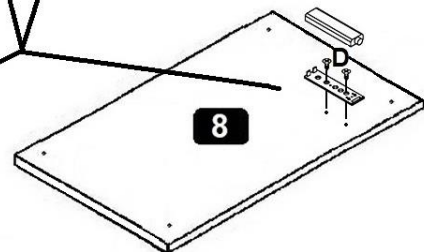
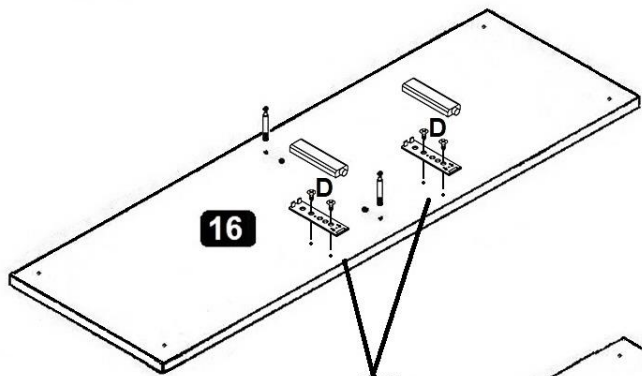
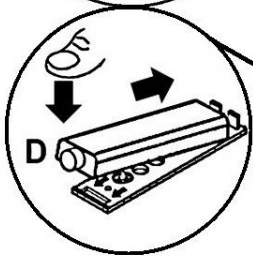
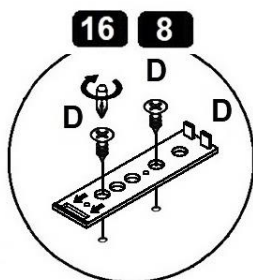
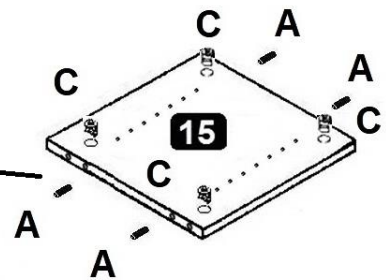
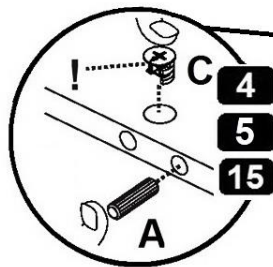
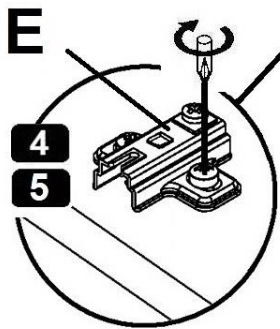
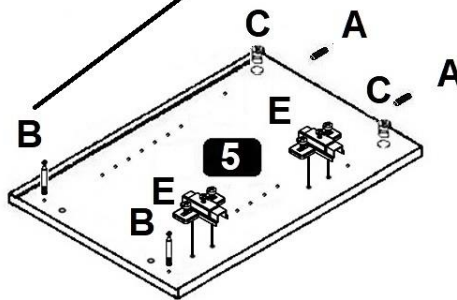
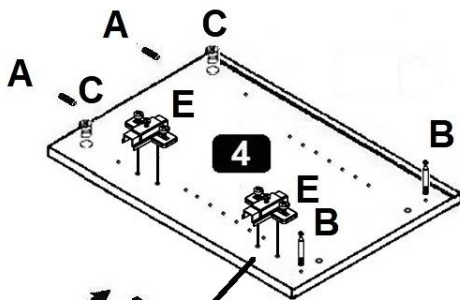
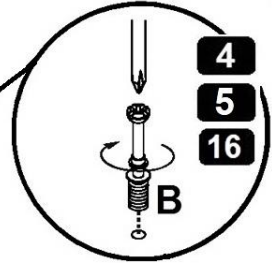
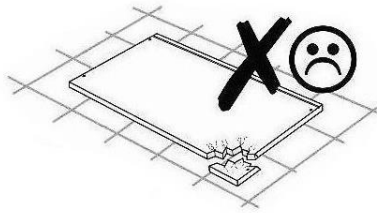
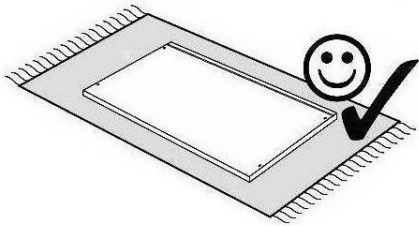
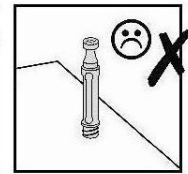
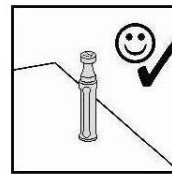

**5**

**A** 8,0 x 30 mm **8x**

**C**  **8x**

**E**  h=2 **2x**

**K** 6,3 x 13 mm **16x**

**L** 17 x 310 mm **8x**

**D**  3,9x9,5mm **4x**

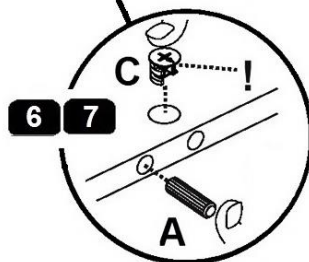
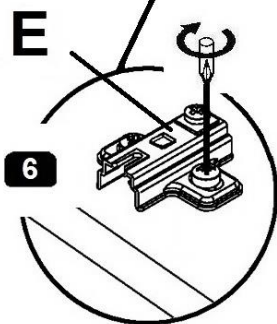
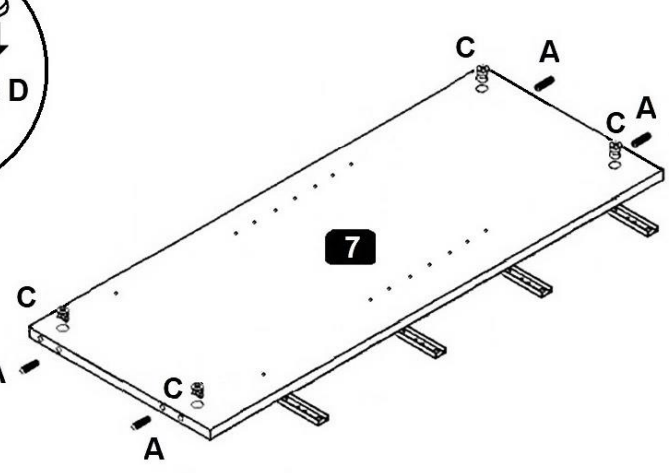
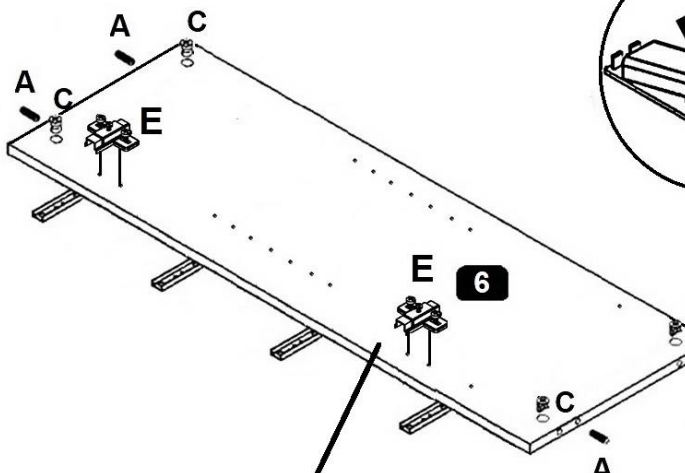
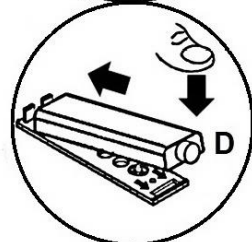
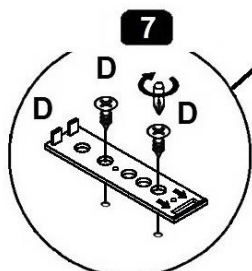
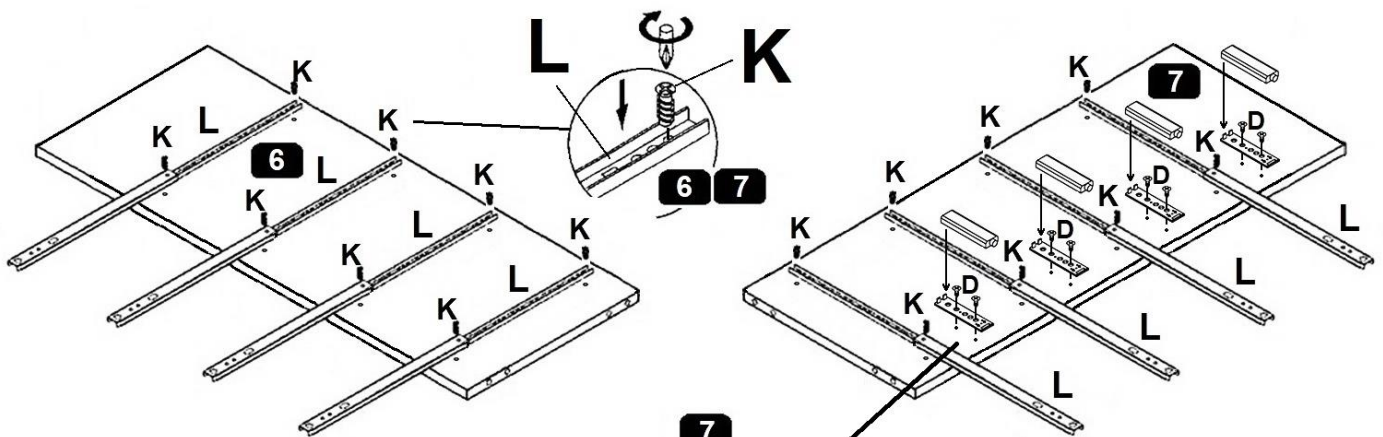
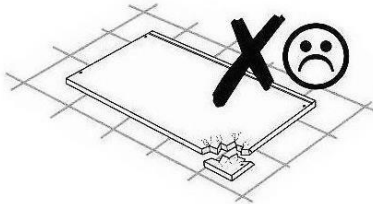
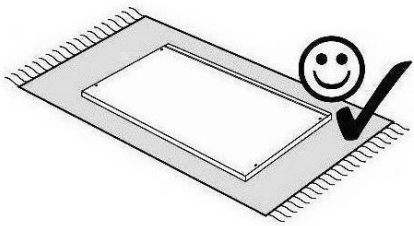

MA1

# 6

F Ø35 Kr.0 3,5x13 mm 4x  
N Ø35 Kr.8 3,5x13 mm 2x

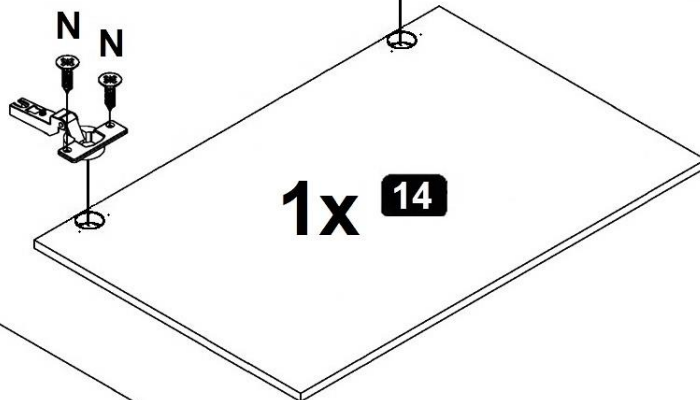
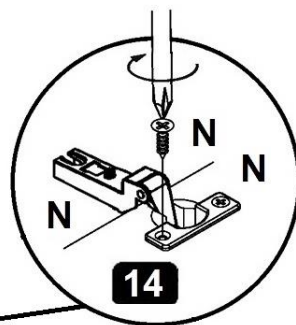
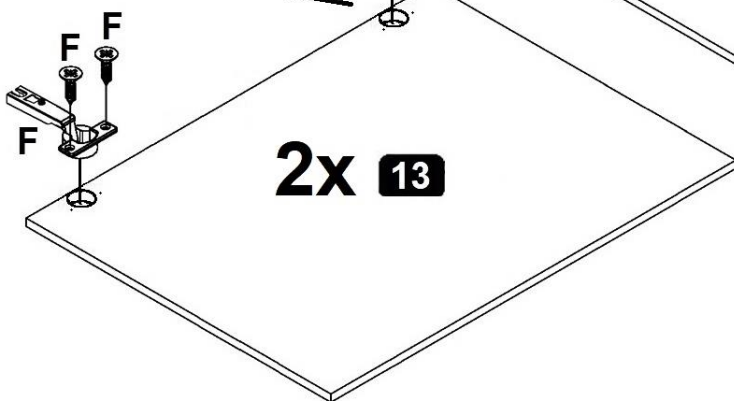
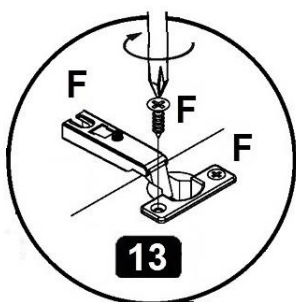
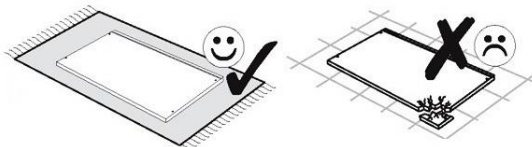

# 7

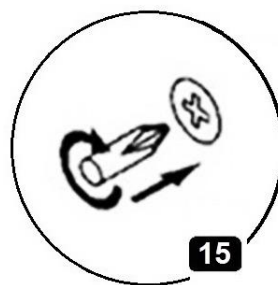
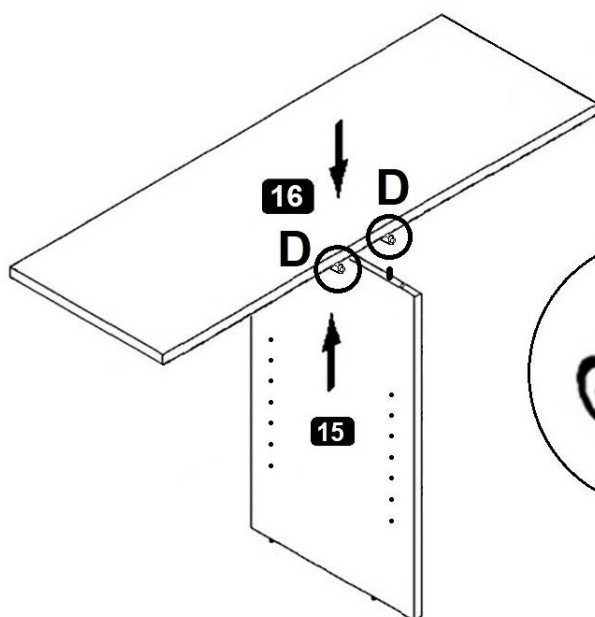



**8**

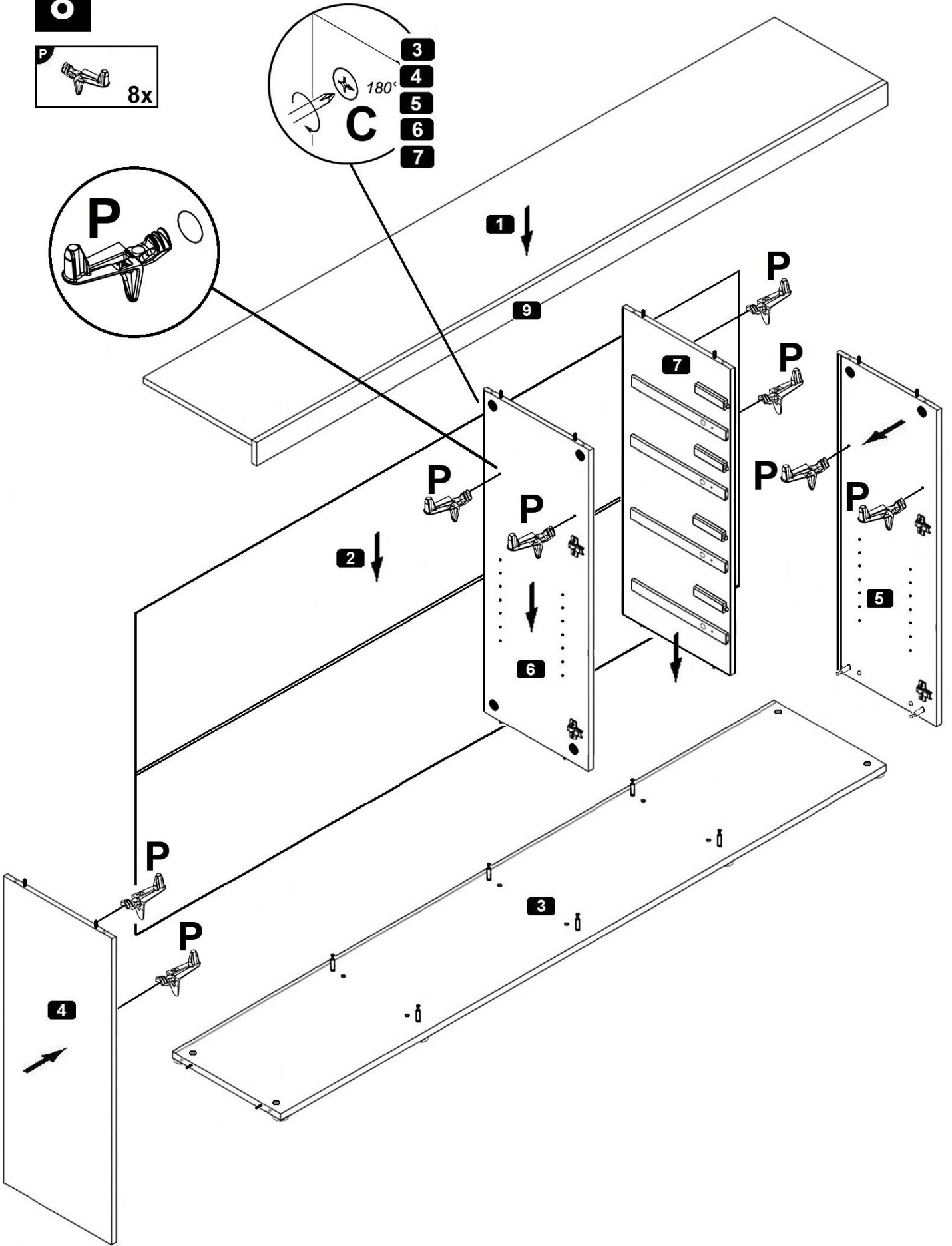
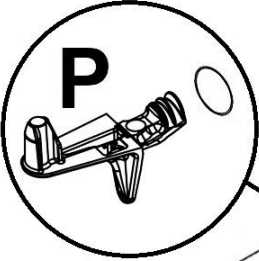
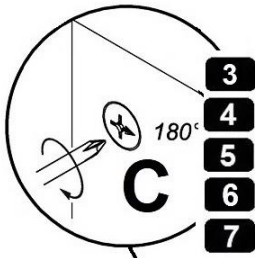
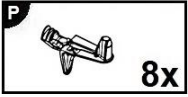

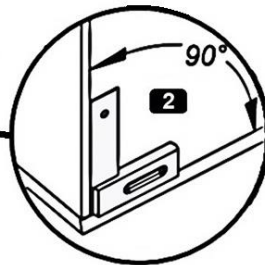
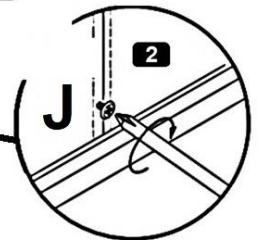
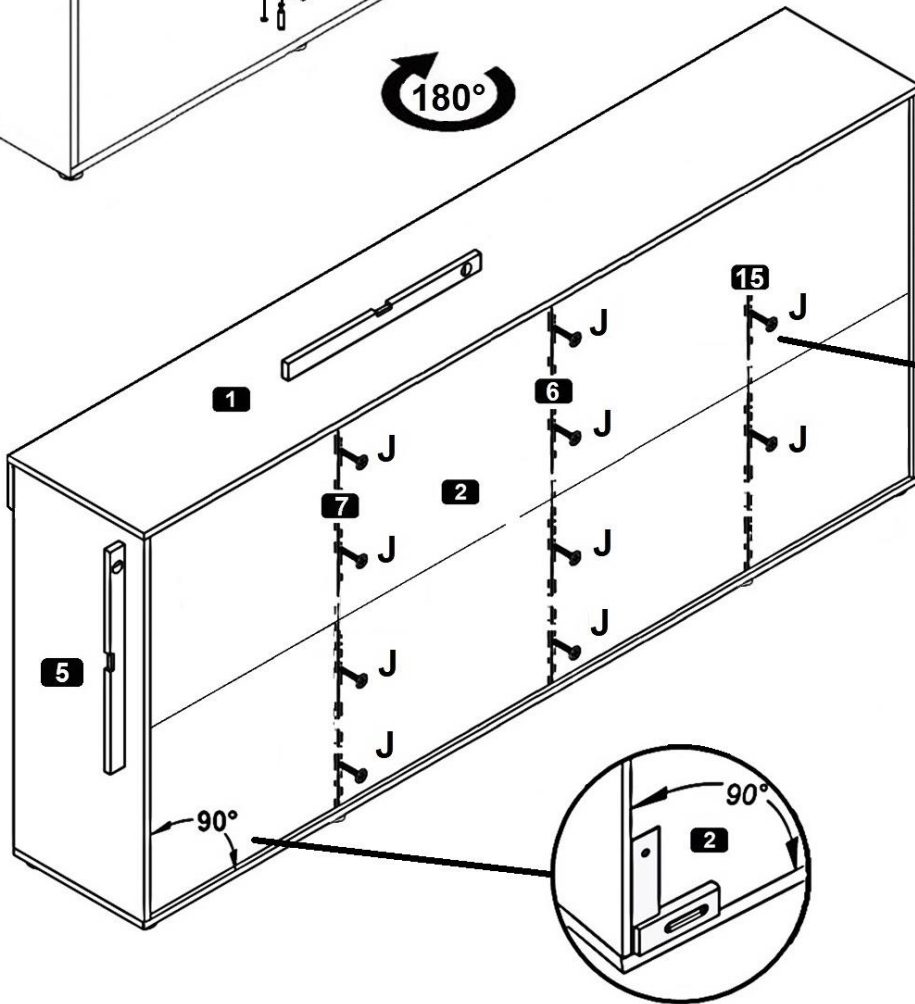
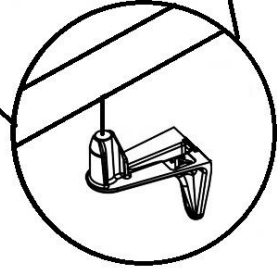
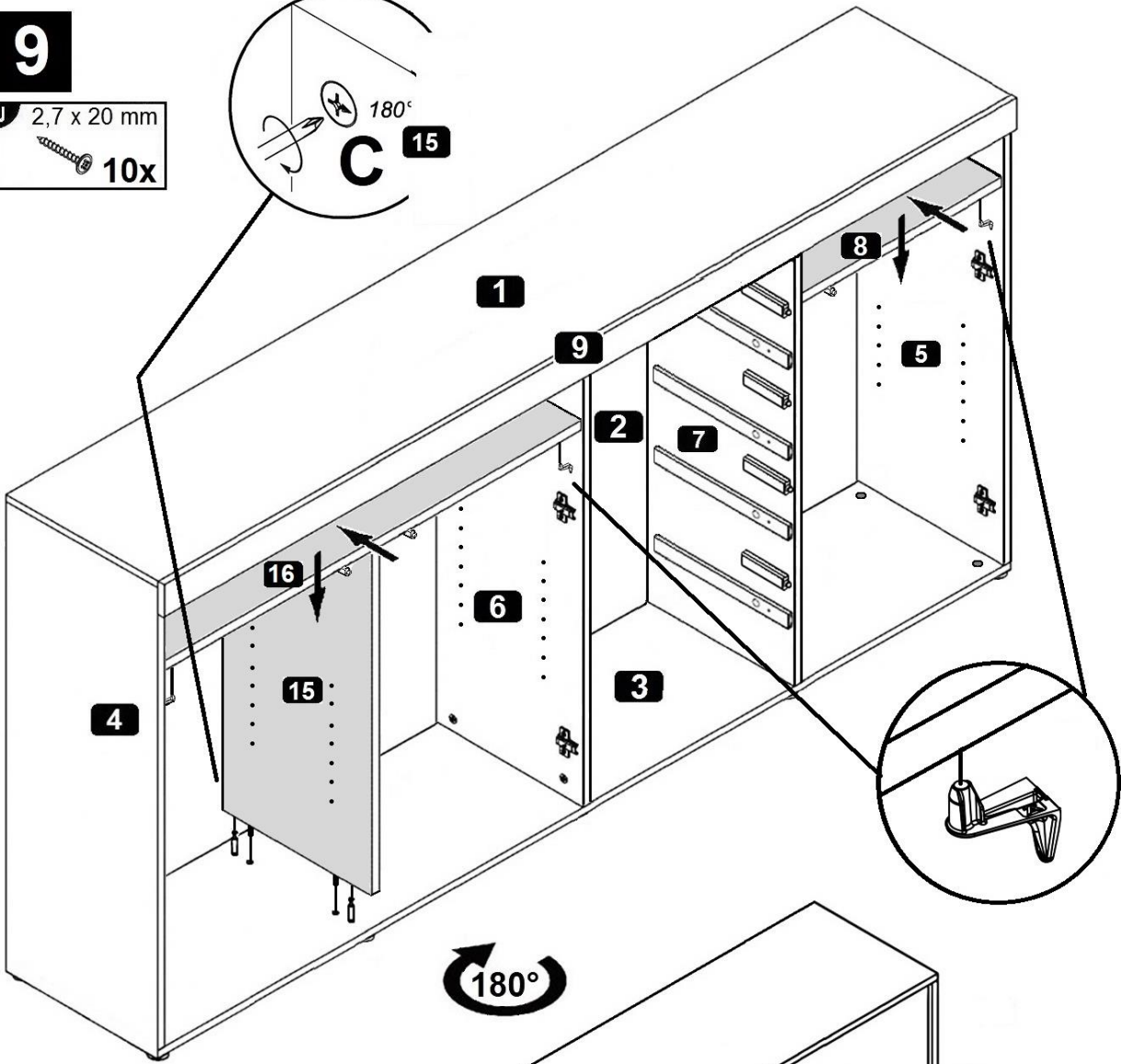
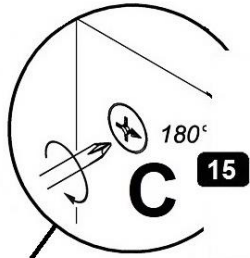

**9**

J 2,7 x 20 mm  
10x



MA1

# 10

M	M4,0 x 9 mm
	8x
O	
	12x

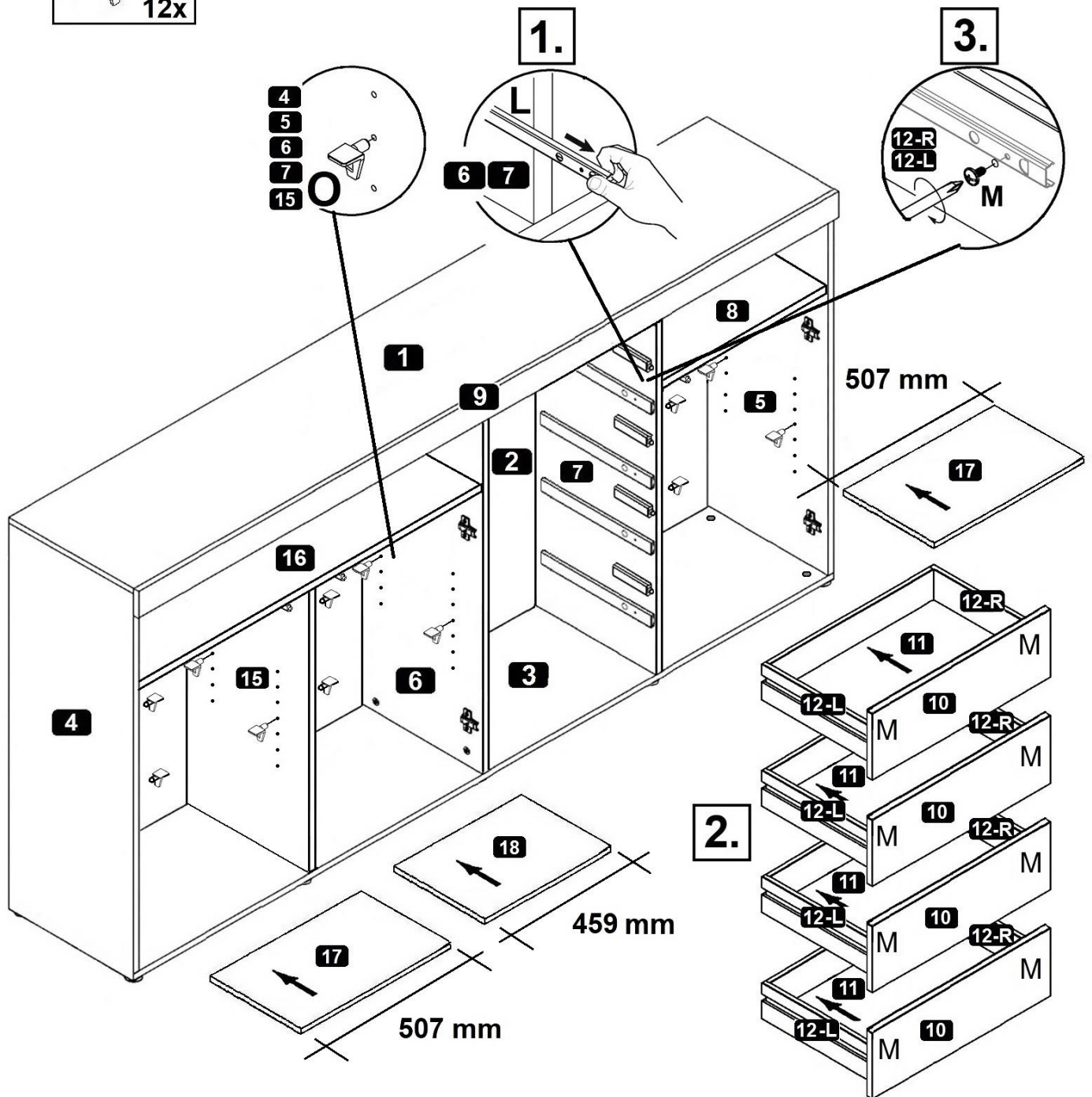

11

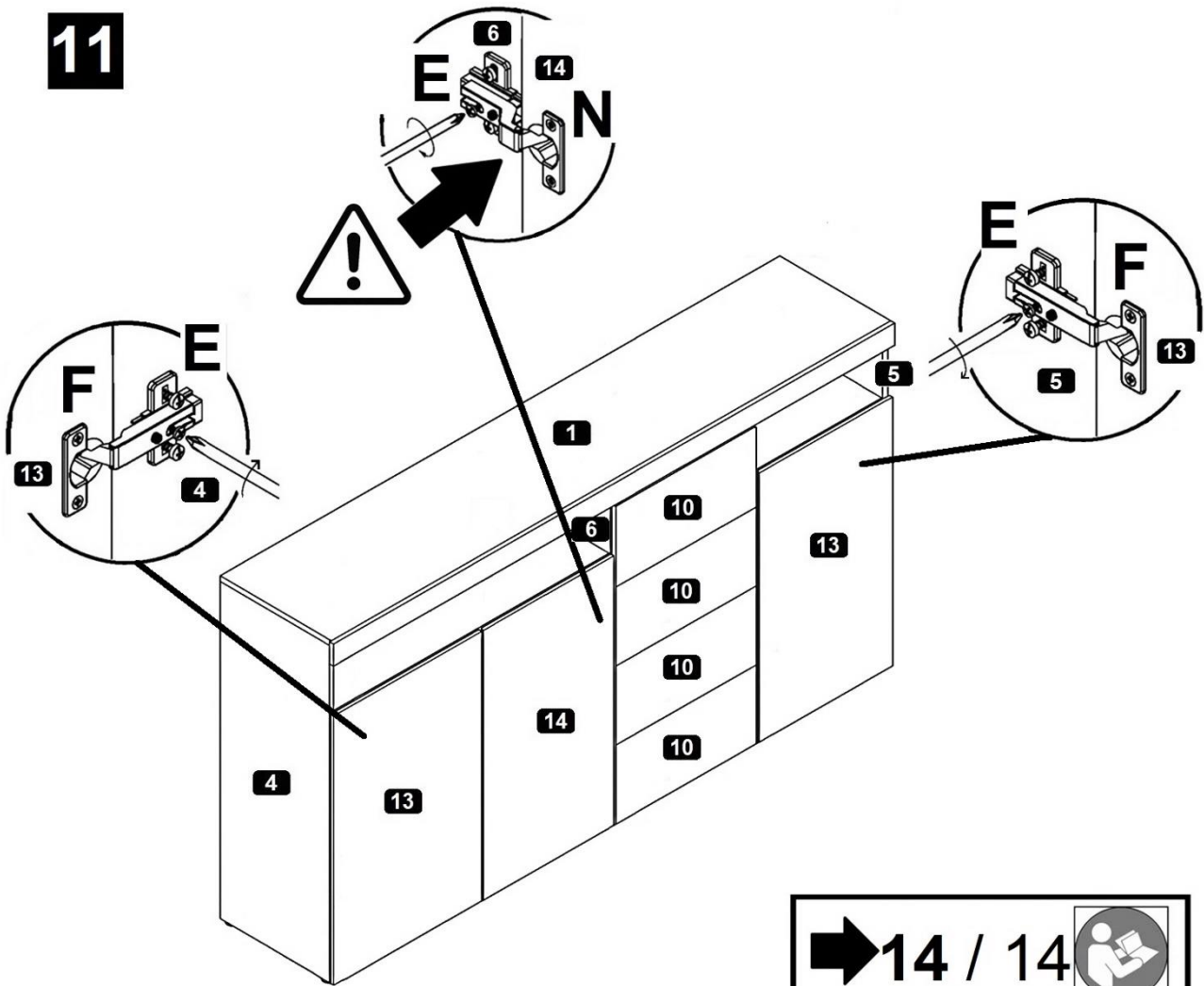

**➔ 13 / 14**

- (D) Push-To-Open einstellen
- (GB) Adjusting the Push-To-Open
- (FR) Régler les Push-To-Open
- (IT) Sistemare Push-To-Open
- (NL) Push-To-Open instellen
- (PL) Nastawić Push-To-Open
- (CZ) Vyrovnajte Push-To-Open
- (RO) Nastavenie Push-To-Open
- (HU) Állítsa be az Push-To-Open
- (SK) Reglare Push-To-Open
- (TR) Push-To-Open ayarlanması
- (RU) Регулировка Push-To-Open

**➔ 14 / 14**

- (D) Türen einstellen (Scharniere justieren)
- (GB) Adjusting the doors (adjusting the hinges)
- (FR) Régler les portes (ajuster les charnières)
- (IT) Sistemare le porte (regolare le cerniere)
- (NL) Deuren instellen (scharnieren afstellen)
- (PL) Nastawić drzwi (wyregulować zawiasy)
- (CZ) Vyrovnajte dvířka (seřid'te závěsy)
- (RO) Nastavenie dverí (nastavenie závesov)
- (HU) Állítsa be az ajtókat (állítsa be a zsanérokat)
- (SK) Reglare uši (ajustare balamale)
- (TR) Kapıların ayarlanması (menteşelerin seviye ayarı)
- (RU) Регулировка дверей (регулировка шарнира)

**12**

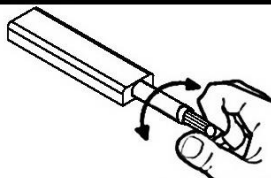

(D) **Push-To-Open einstellen**

(GB) **Adjusting the Push-To-Open**

(FR) **Régler les Push-To-Open**

(IT) **Sistemare Push-To-Open**

(NL) **Push-To-Open instellen**

(PL) **Nastawić Push-To-Open**

(CZ) **Vyrovnejte Push-To-Open**

(RO) **Nastavenie Push-To-Open**

(HU) **Állítsa be az Push-To-Open**

(SK) **Reglare Push-To-Open**

(TR) **Push-To-Open ayarlanması**

(RU) **Регулировка Push-To-Open**

**1.**

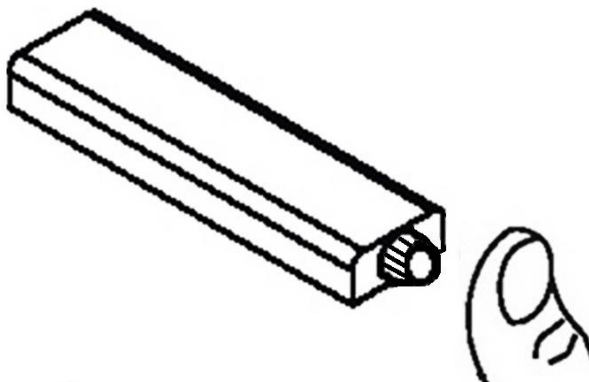

**2.**

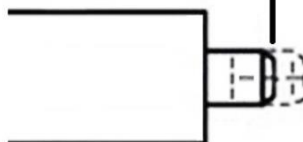
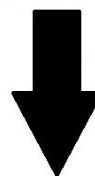
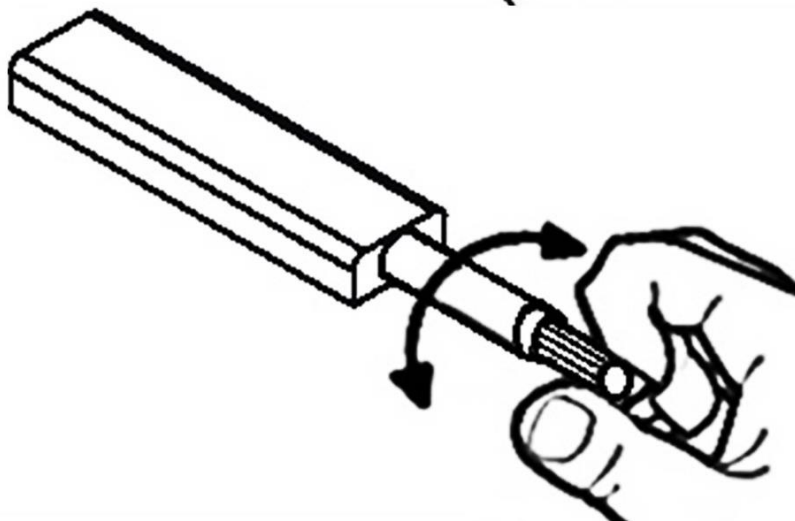

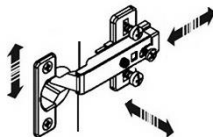

(D) Türen einstellen  
(Scharniere justieren)

(GB) Adjusting the doors  
(adjusting the hinges)

(FR) Régler les portes  
(ajuster les charnières)

(IT) Sistemare le porte  
(regolare le cerniere)

(NL) Deuren instellen  
(scharnieren afstellen)

(PL) Nastawić drzwi  
(wyregulować zawiasy)

(CZ) Vyrovnajte dvířka  
(seřid'ťe závěsy)

(RO) Nastavenie dverí  
(nastavenie závesov)

(HU) Állítsa be az ajtókat  
(állítsa be a zsanérokát)

(SK) Reglare uši  
(ajustare balamale)

(TR) Kapıların ayarlanması  
(menteşelerin seviye ayarı)

(RU) Регулировка дверей  
(регулировка шарнира)

