

Ersatzteilliste

Spare parts list

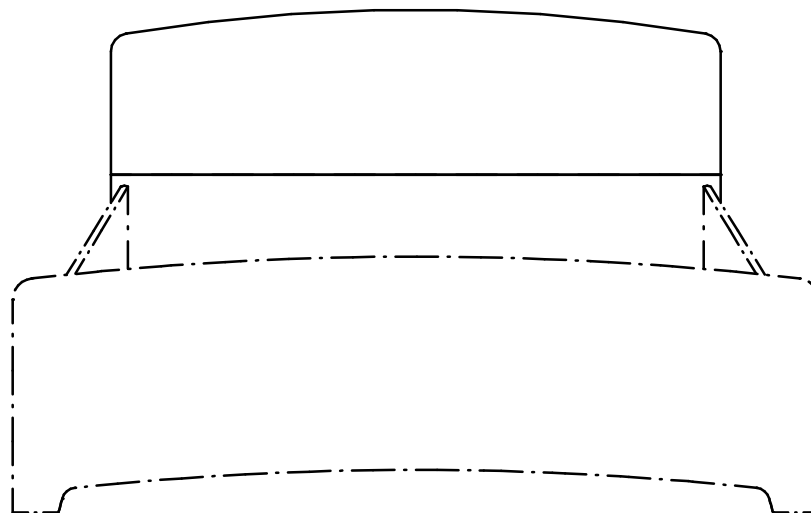

Kopfteilaufsatz ohne NA
headboard without bed table bord

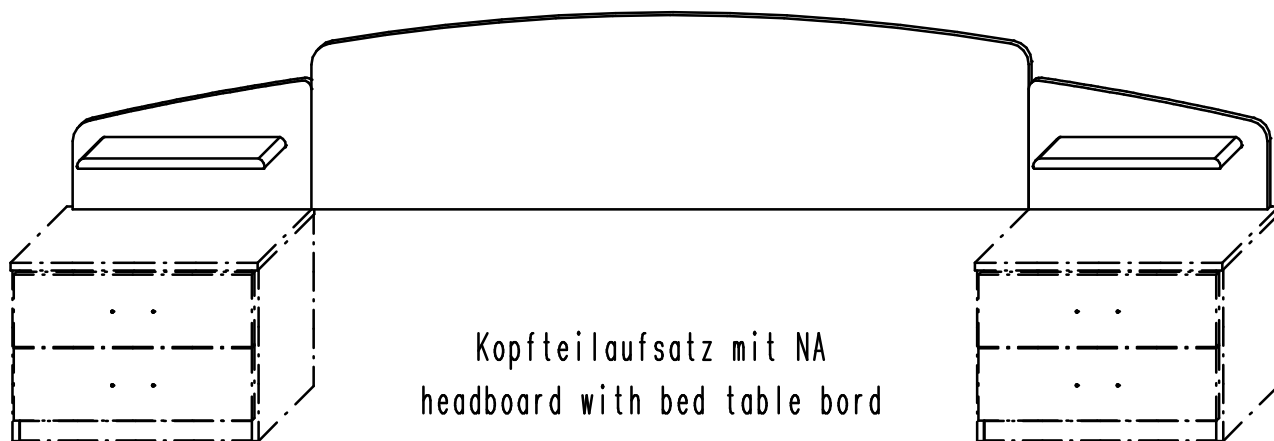

Kopfteilaufsatz mit NA
headboard with bed table bord

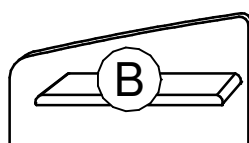

Option

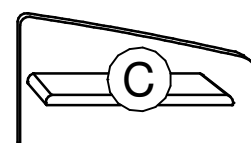
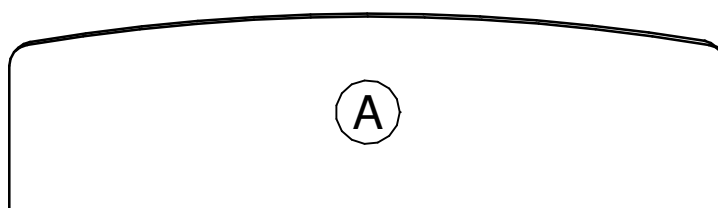

Option

Ersatzteilliste

Spare parts list

624.0092.000

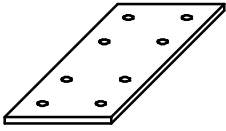

①

6 x

631.1460.000

4 x 15 mm



②

44 x

631.1201.000

7 x 50 mm

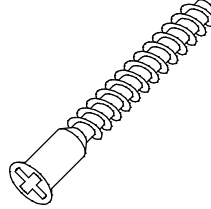

③

4 x

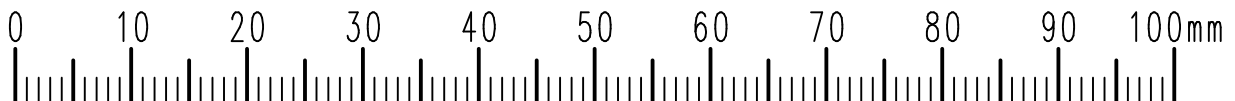

Montageanleitung

Assembly Instructions

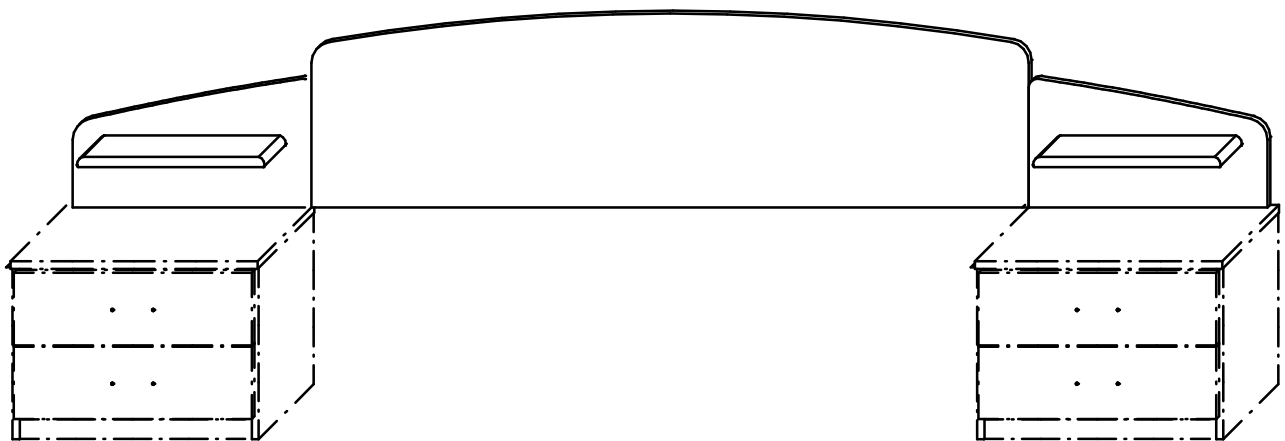
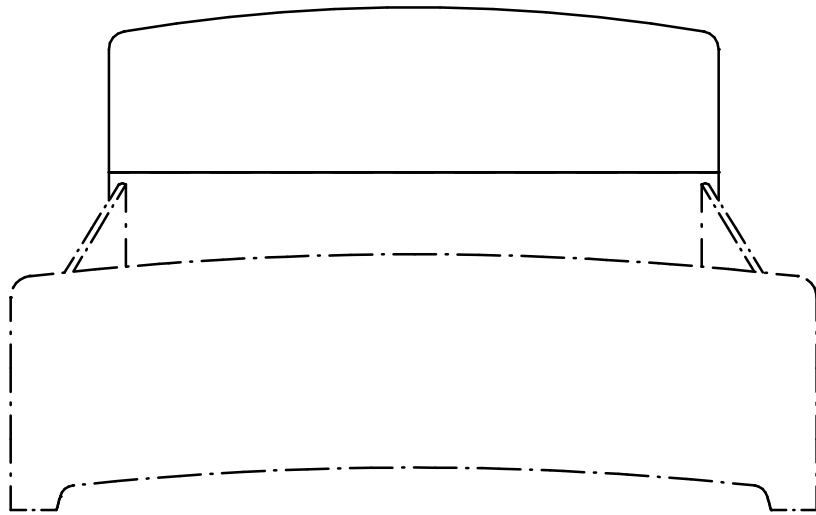
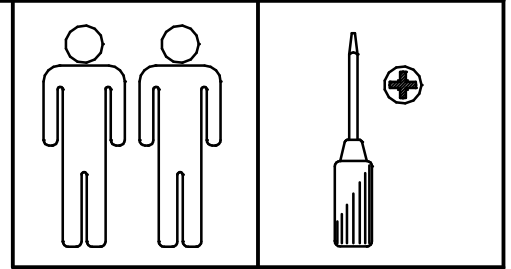

1.

Option

624.0092.000

631.1460.000

4 x 15 mm

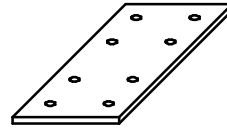

①

②

Position

①

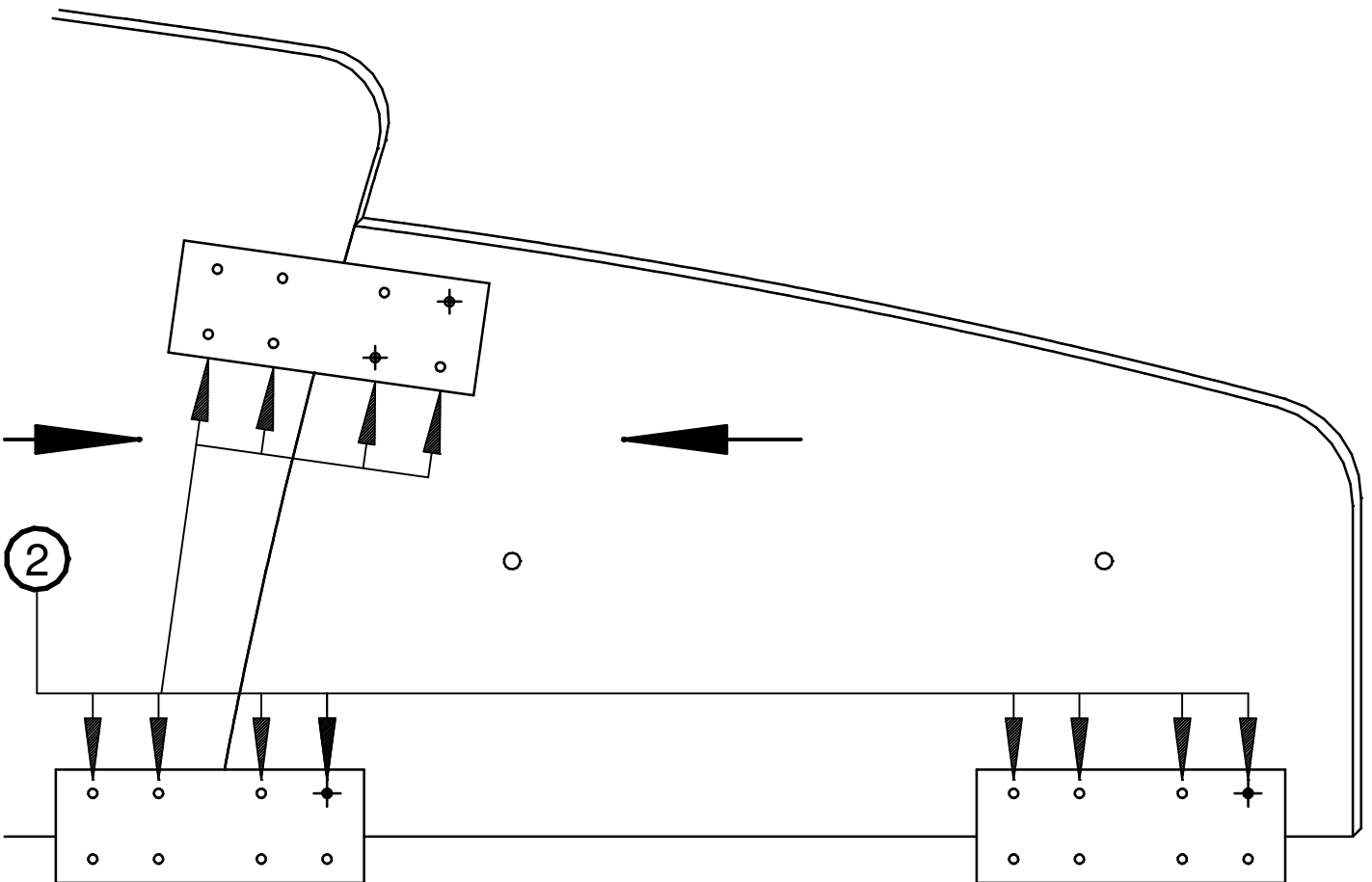
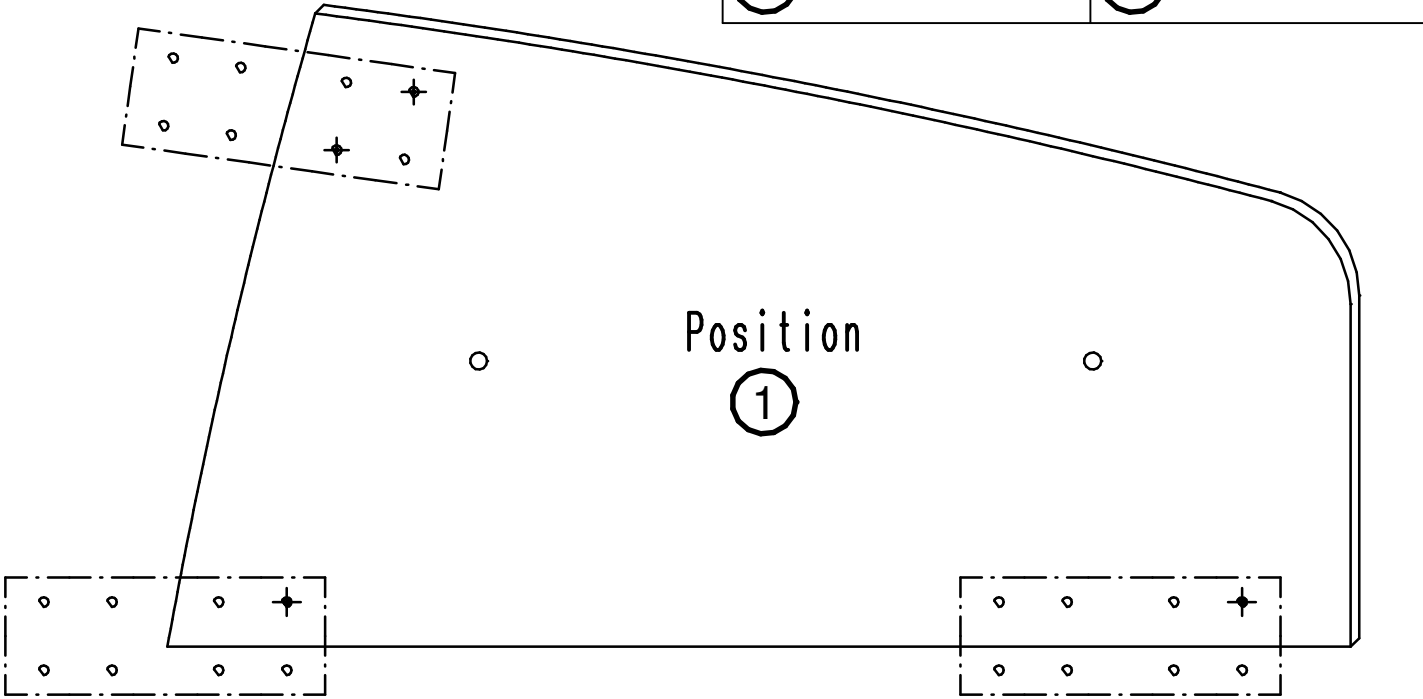

ACHTUNG! / ATTENTION!

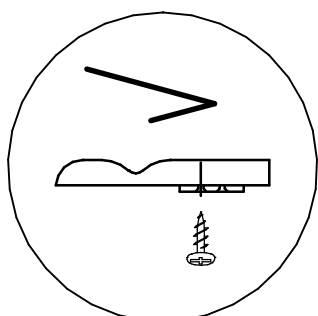
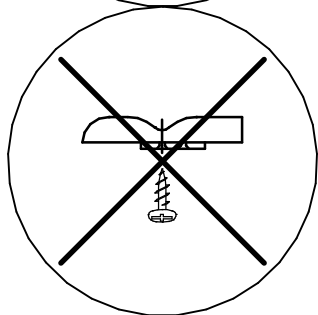

2.

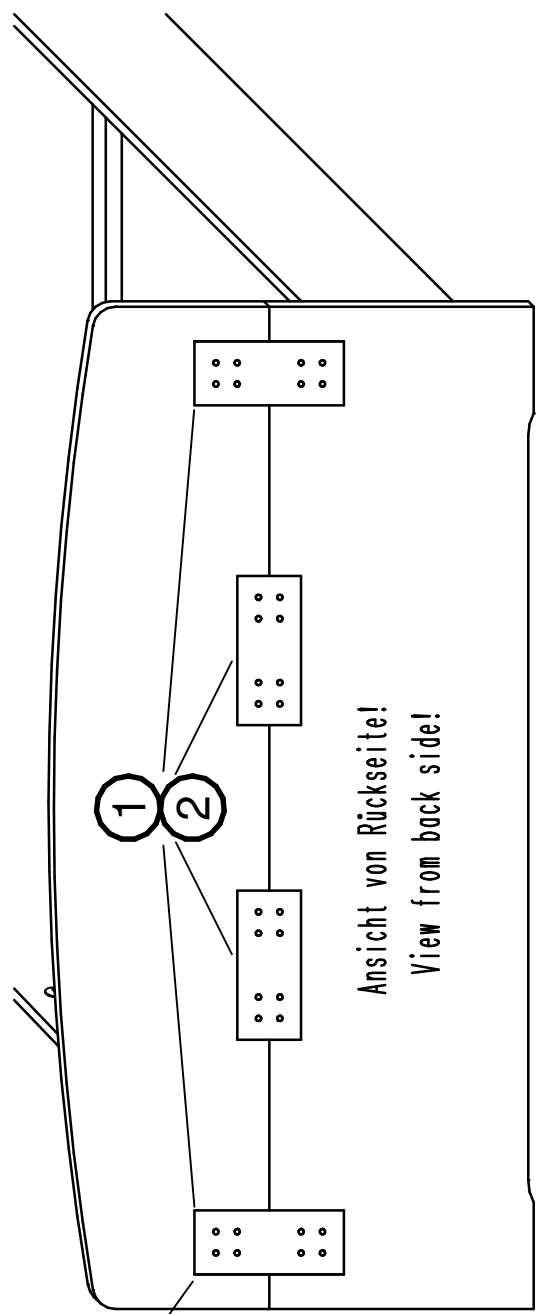

631.1201
7 x 50 mm

③

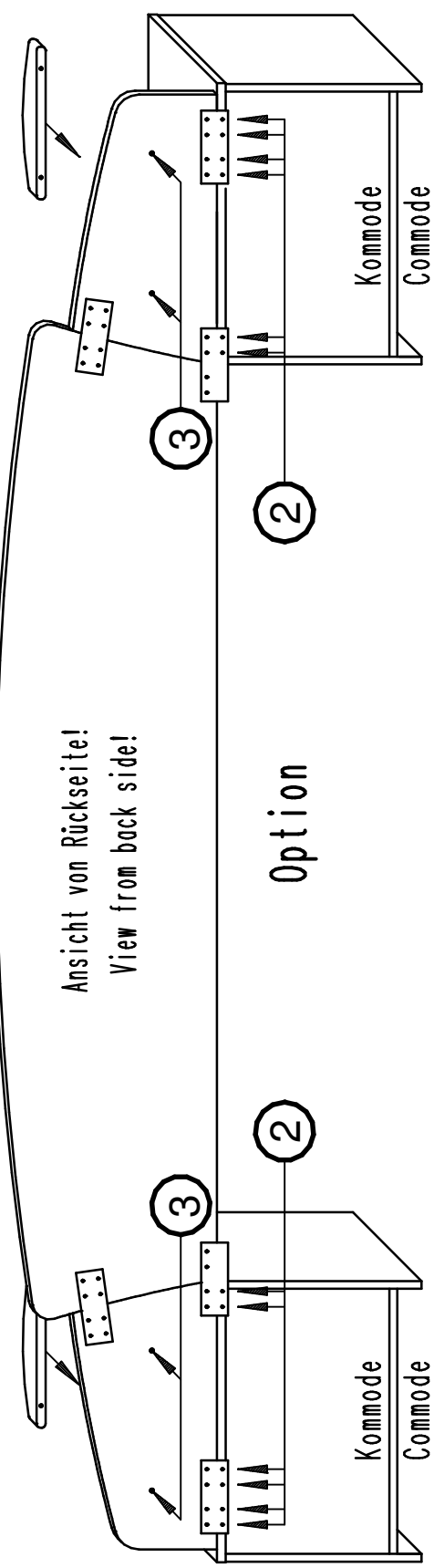

Panel mit Seitenteilen auf die Kommoden stellen. Um den richtigen Abstand der Kommode zu ermitteln, das Bettkopfteil zwischen die Kommoden stellen, das Paneel ausrichten/vermitteln und festschrauben. Place the panel with the side parts on the commodes. In order to determine the correct distance of the commode, place the head part of the bed between the commodes, align/centre the panel and screw tight.

Sollte trotz strenger Fertigungskontrollen ein Teil Grund zur Beanstandung geben, markieren Sie das entsprechende Teil auf dieser Aufbauanleitung und schicken diese per Fax an den Hersteller./

If a part gives a cause for complaint despite strict production controls, please mark the part in question on these instructions and send them by fax to the manufacturer.

Firma, Name/

Company, Name:

Strasse/

Street:

Ort/

Town:

Auftragsnummer/

Commission no.:

Ursache der Beanstandung bitte unbedingt angeben/

Please state the cause of complaint at all costs:

.....

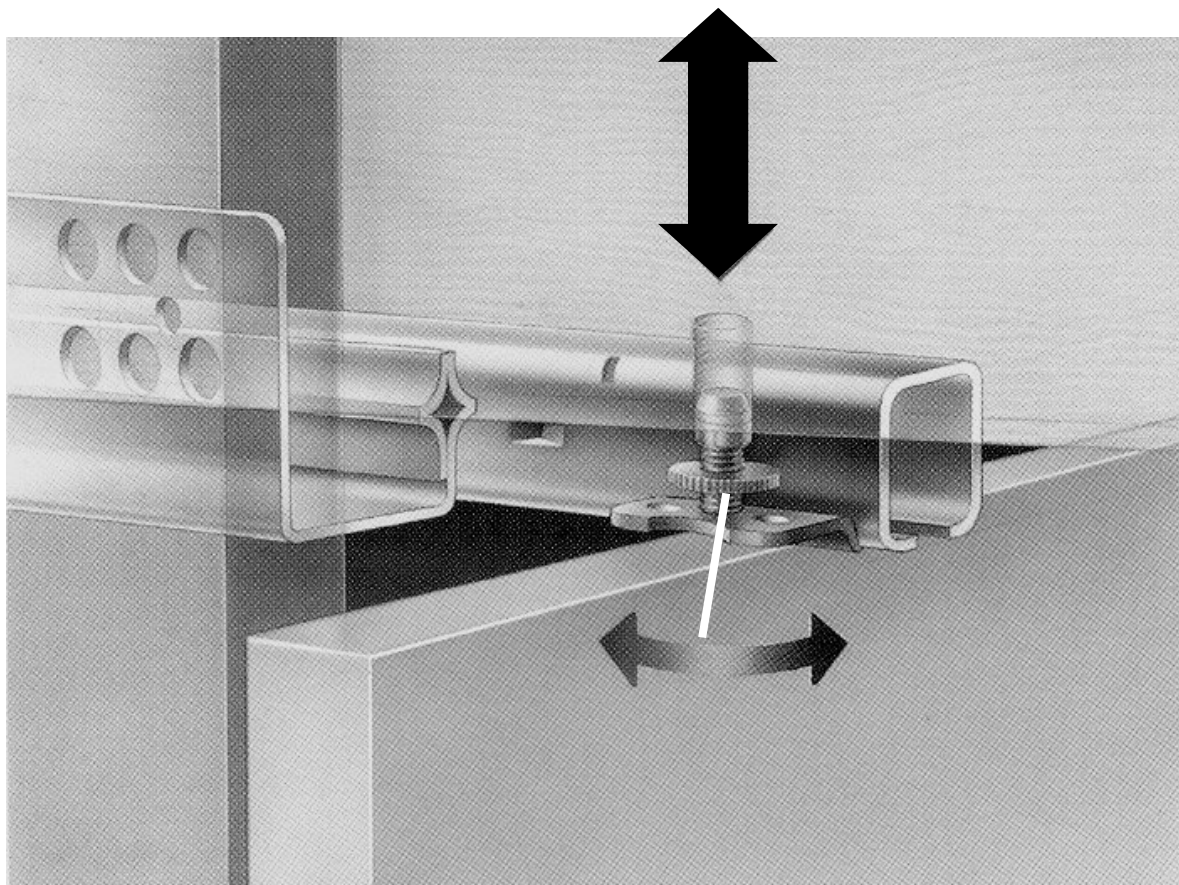
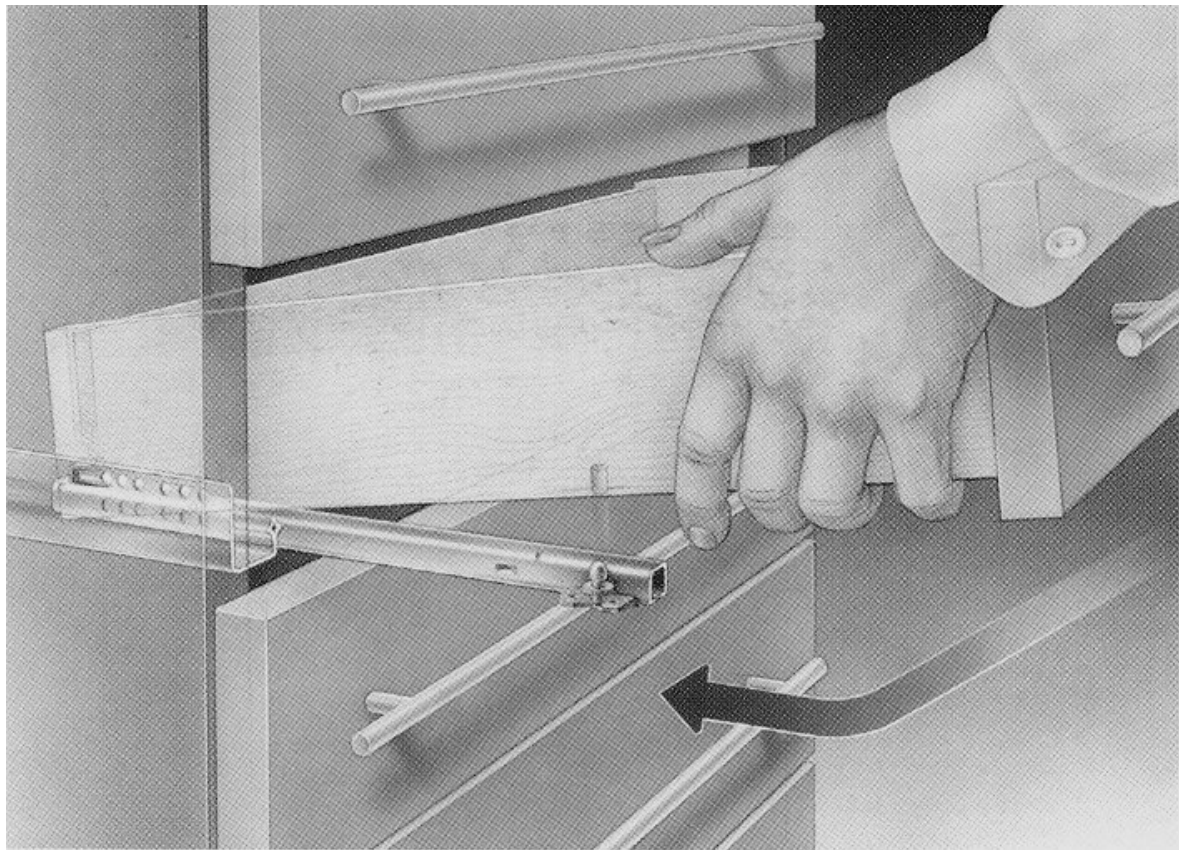

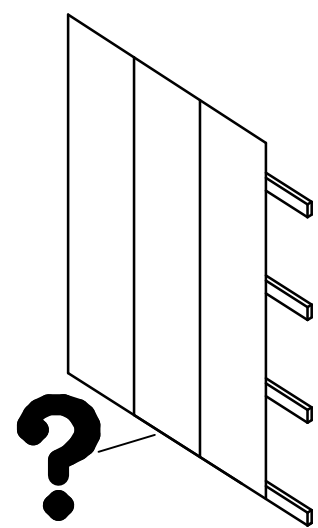
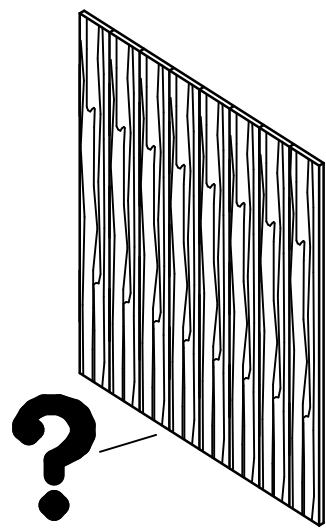
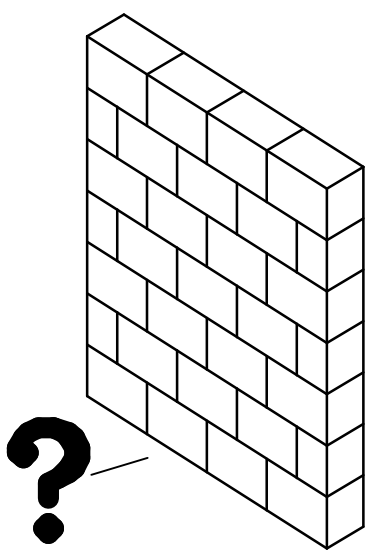
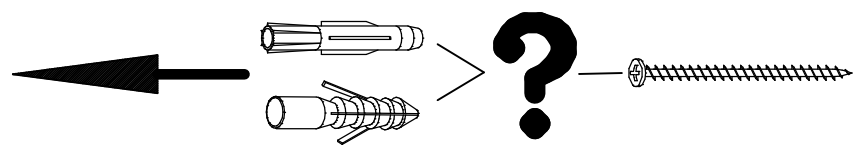
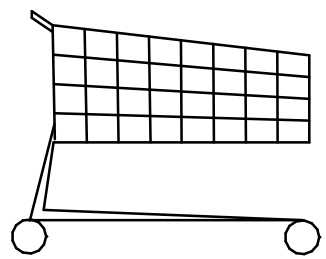
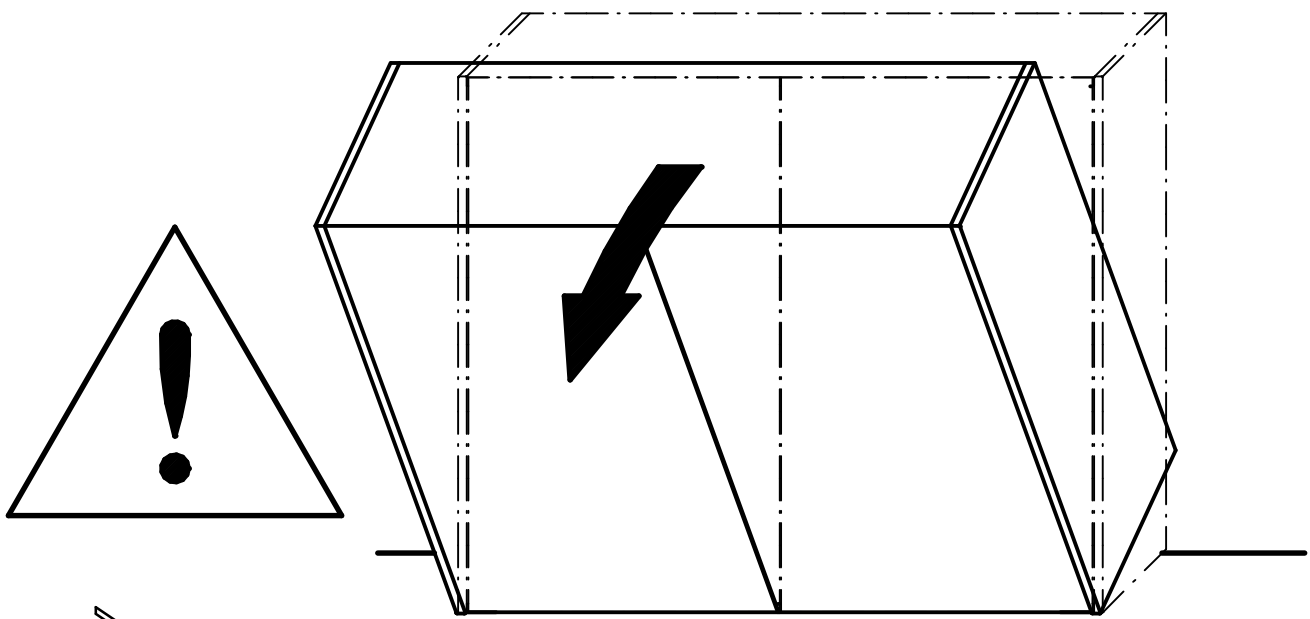
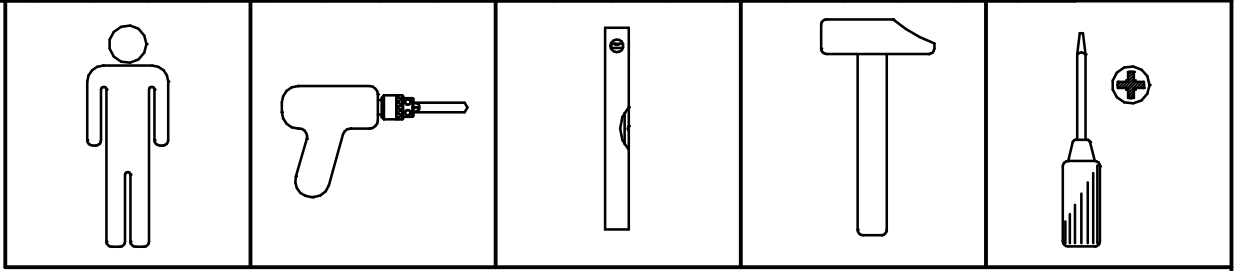
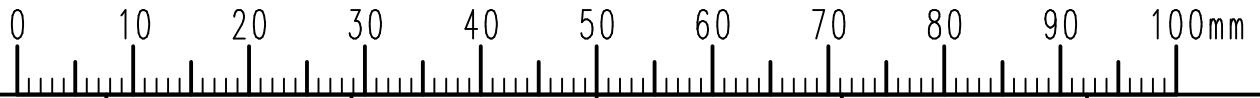

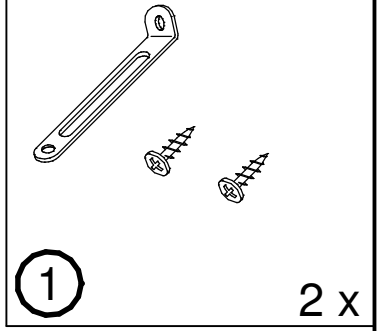
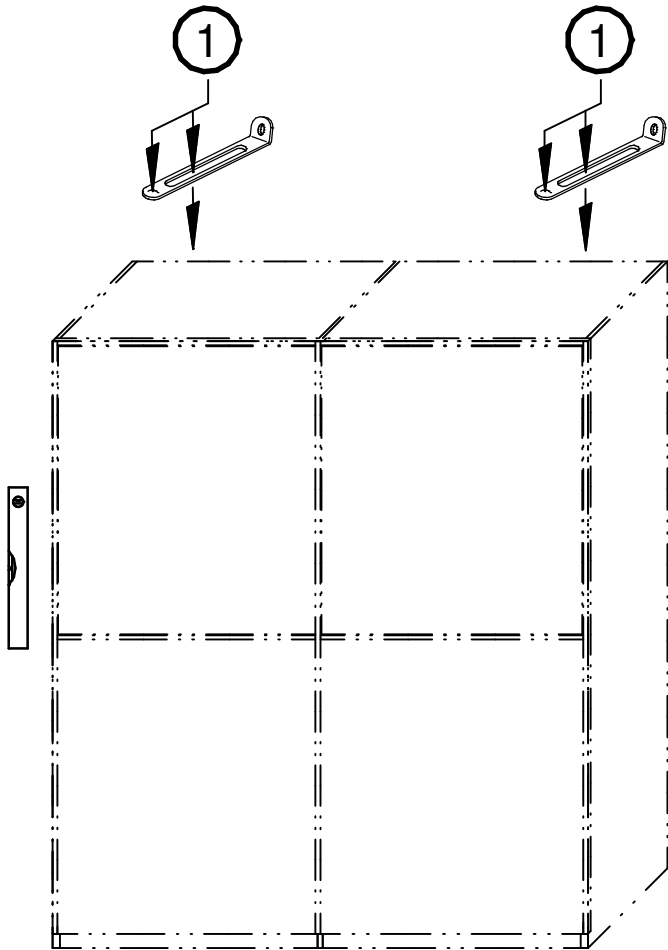

VERSION 1

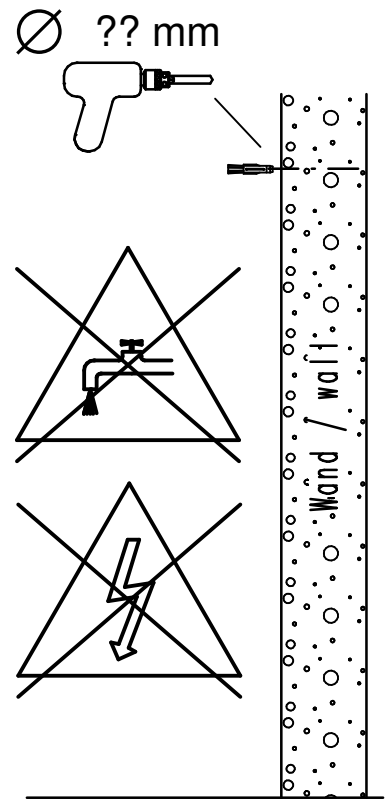
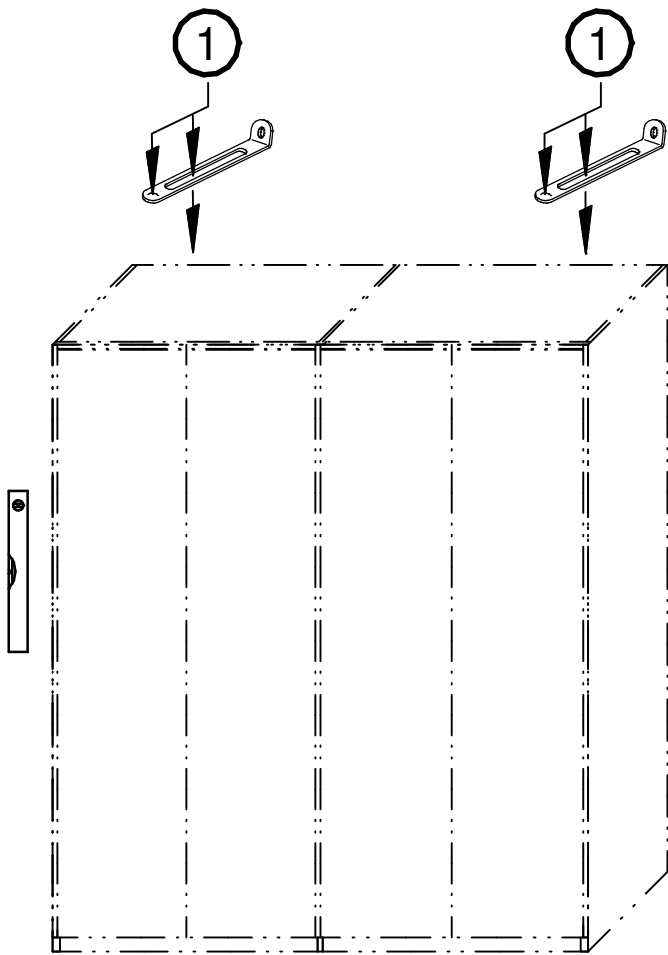

VERSION 2

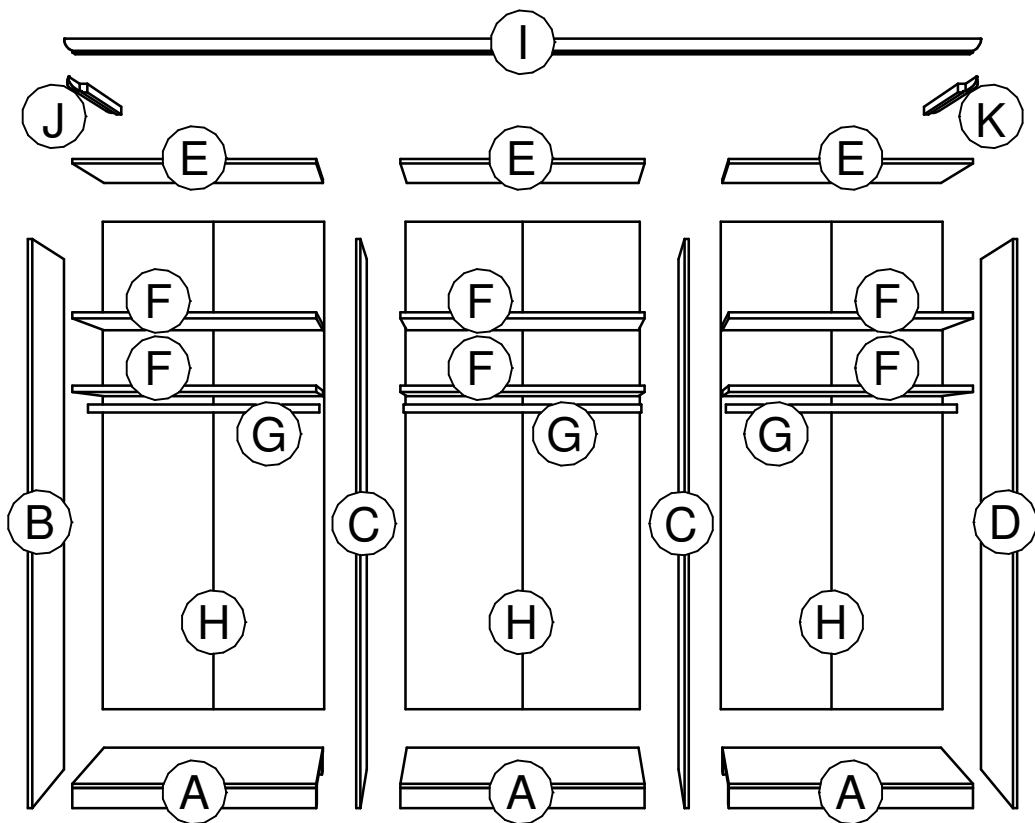
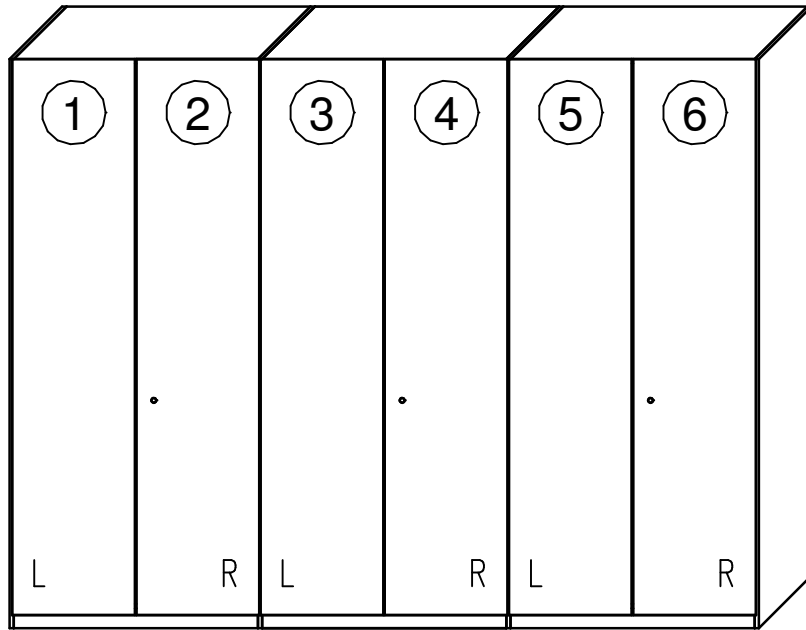
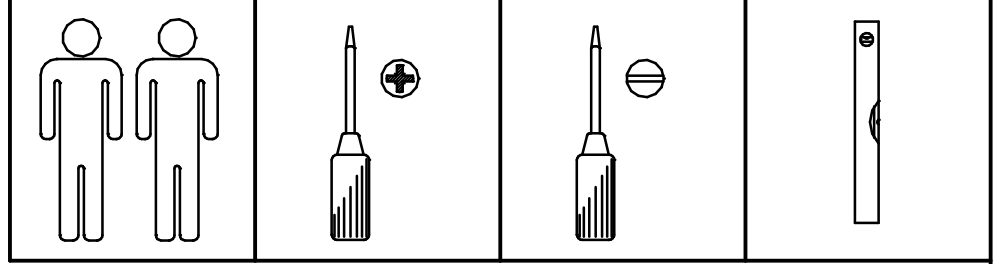
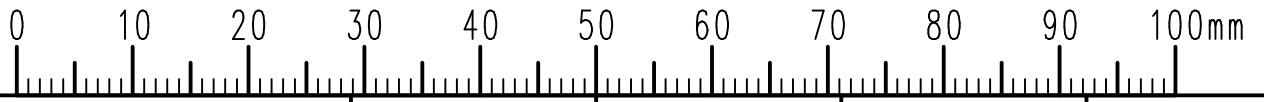

1

449

1 2

916

1 2

784

1 2

784

1 2 3

1 2 3

784
916 449

1 2 3

449 784

1 2 3 4

784 784
916 916

1 2 3 4

1 2 3 4 5

784 784
916 449 916

1 2 3 4 5

1 2 3 4 5 6

784 784
916 916 916

1 2 3 4 5 6

1 2 3 4 5 6 7

784 784
916 916 449 916

1 2 3 4 5 6 7

1 2 3 4 5 6 7 8

784 784
916 916 916 916

1 2 3 4 5 6 7 8

1.

641.0227.000
12 mm



1

2

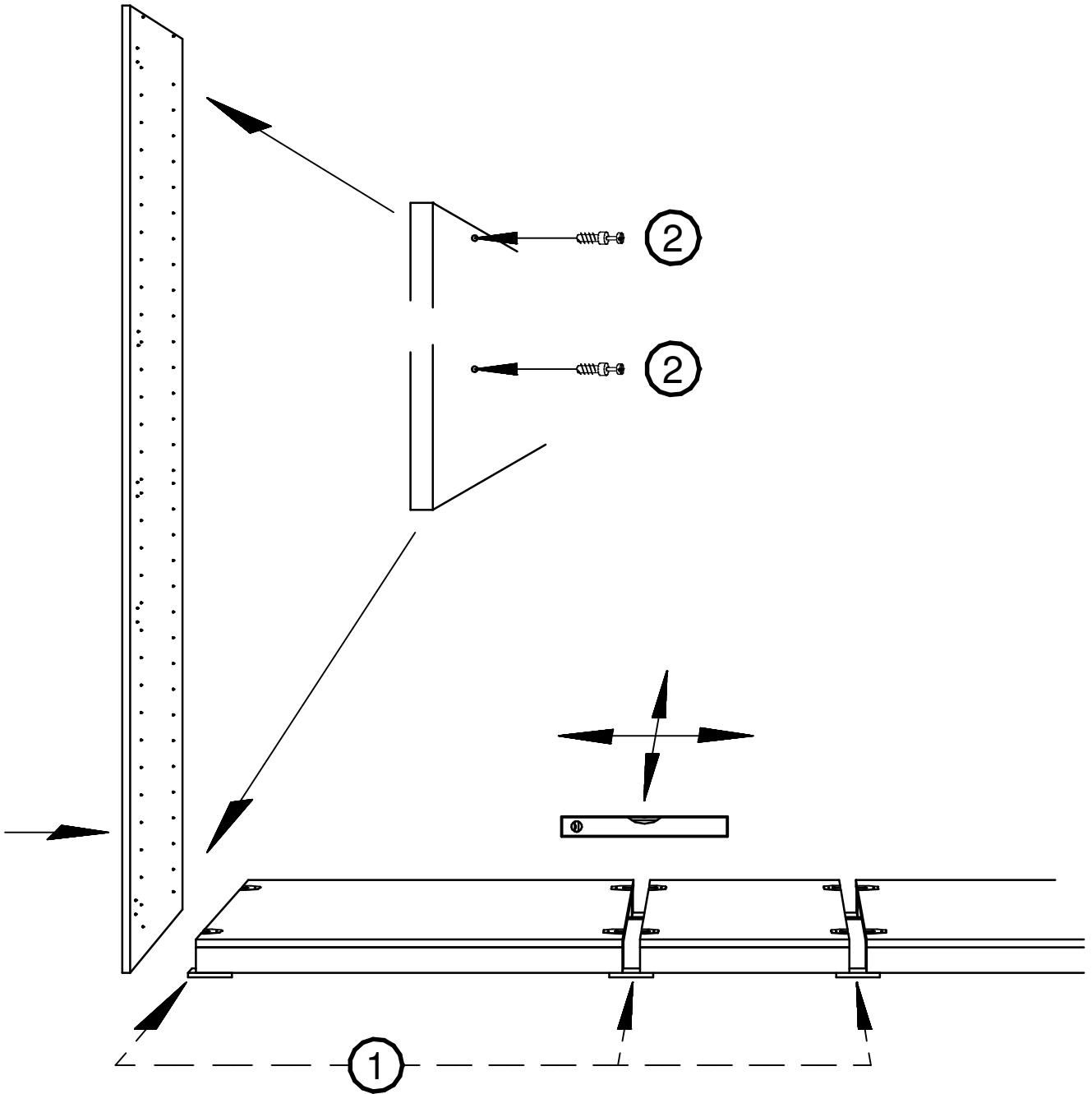

2.

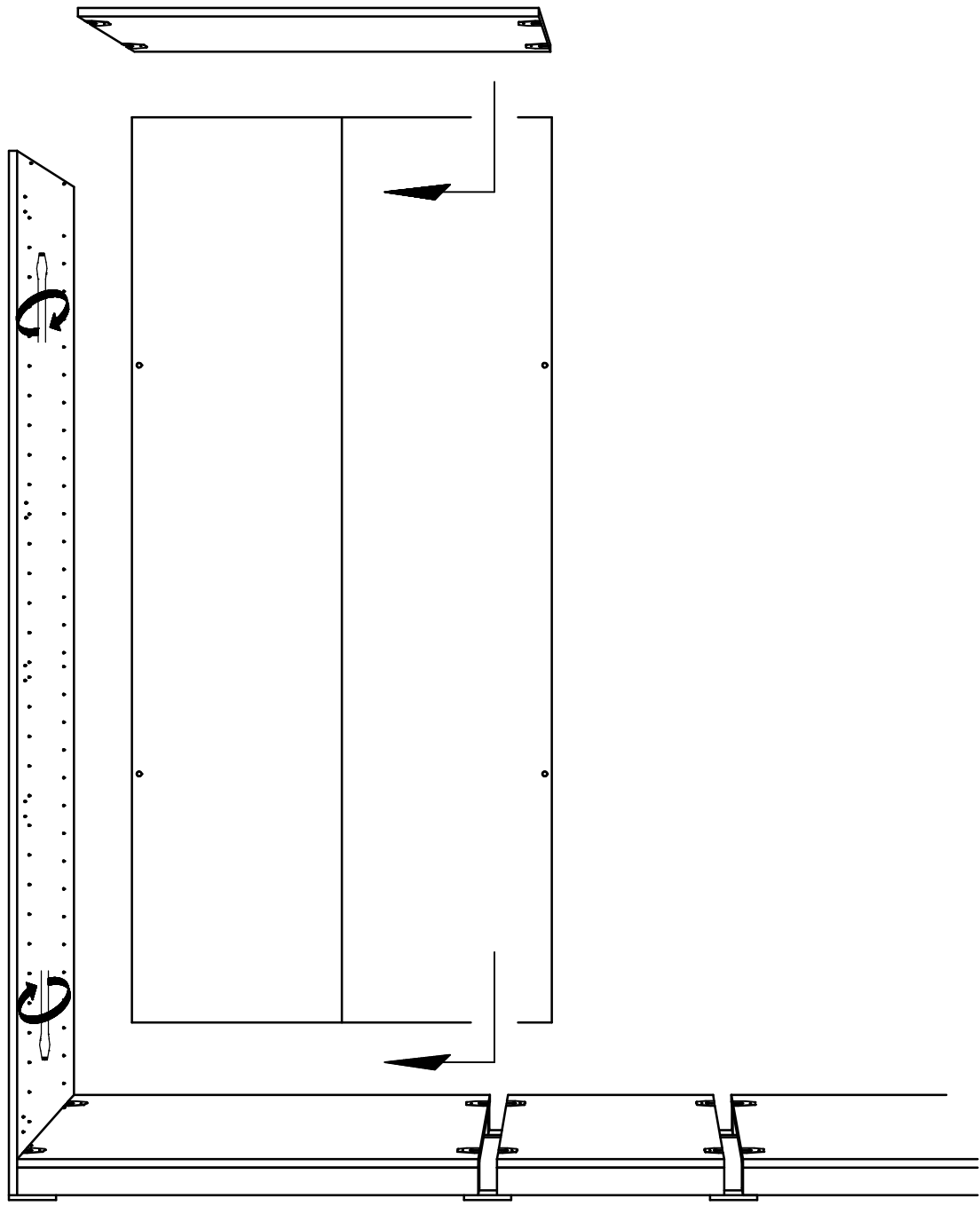

621.2930.000

631.1266.000

6,3 x 11 mm

631.1472.000

3,5 x 15 mm

641.0226.000

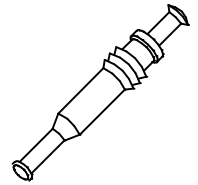
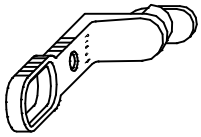

3

4

5

6

3.

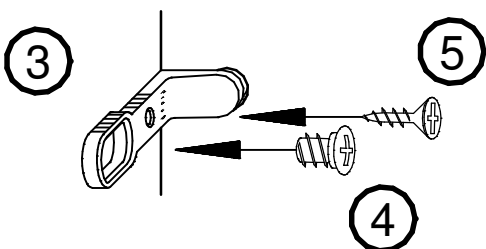
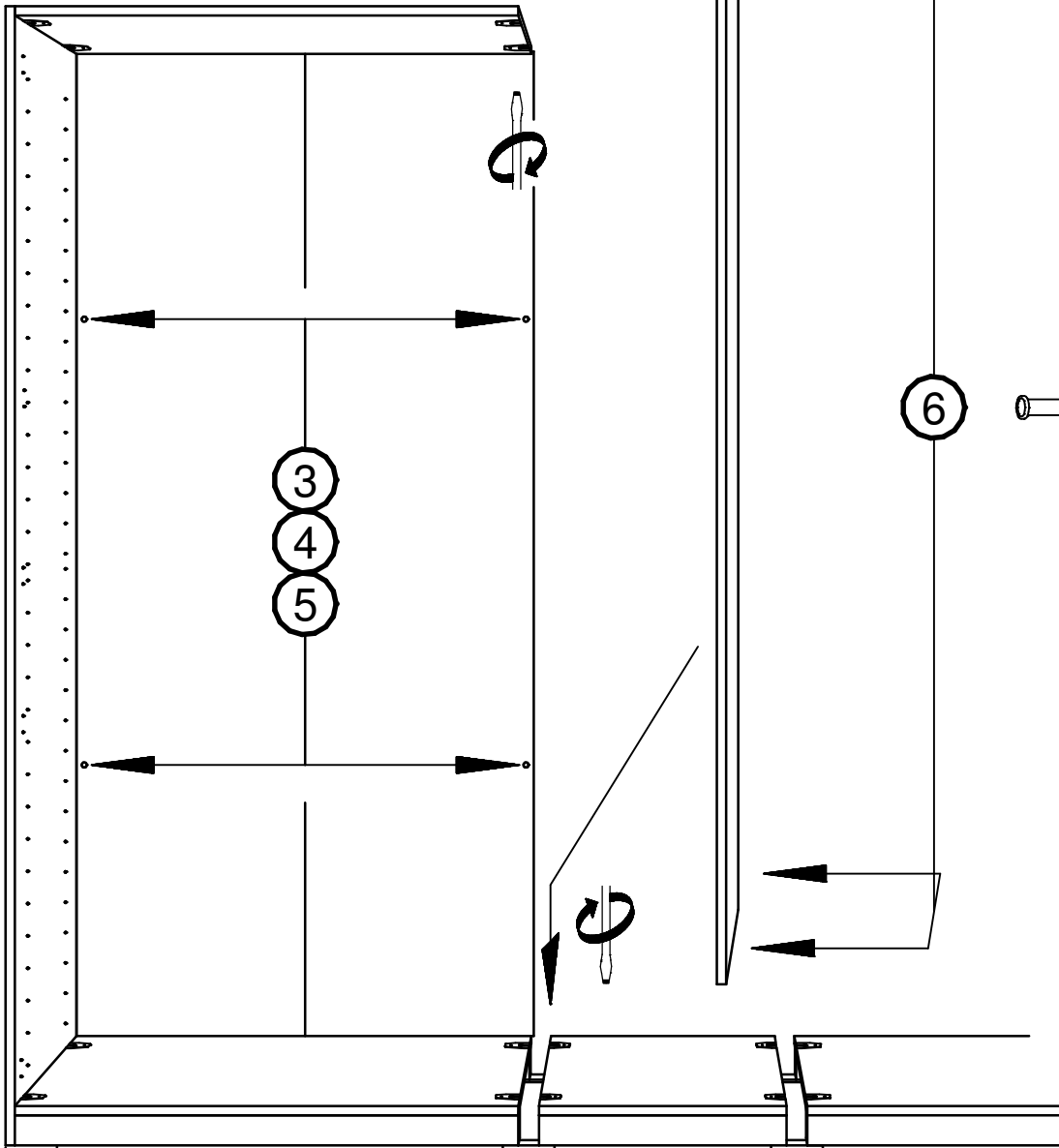

621.0033.000

621.1303.000

641.0004.000

621.0069.000

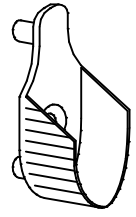
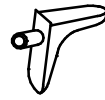
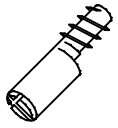

7

option

8

9

10

4.

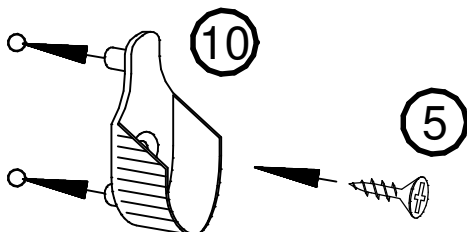
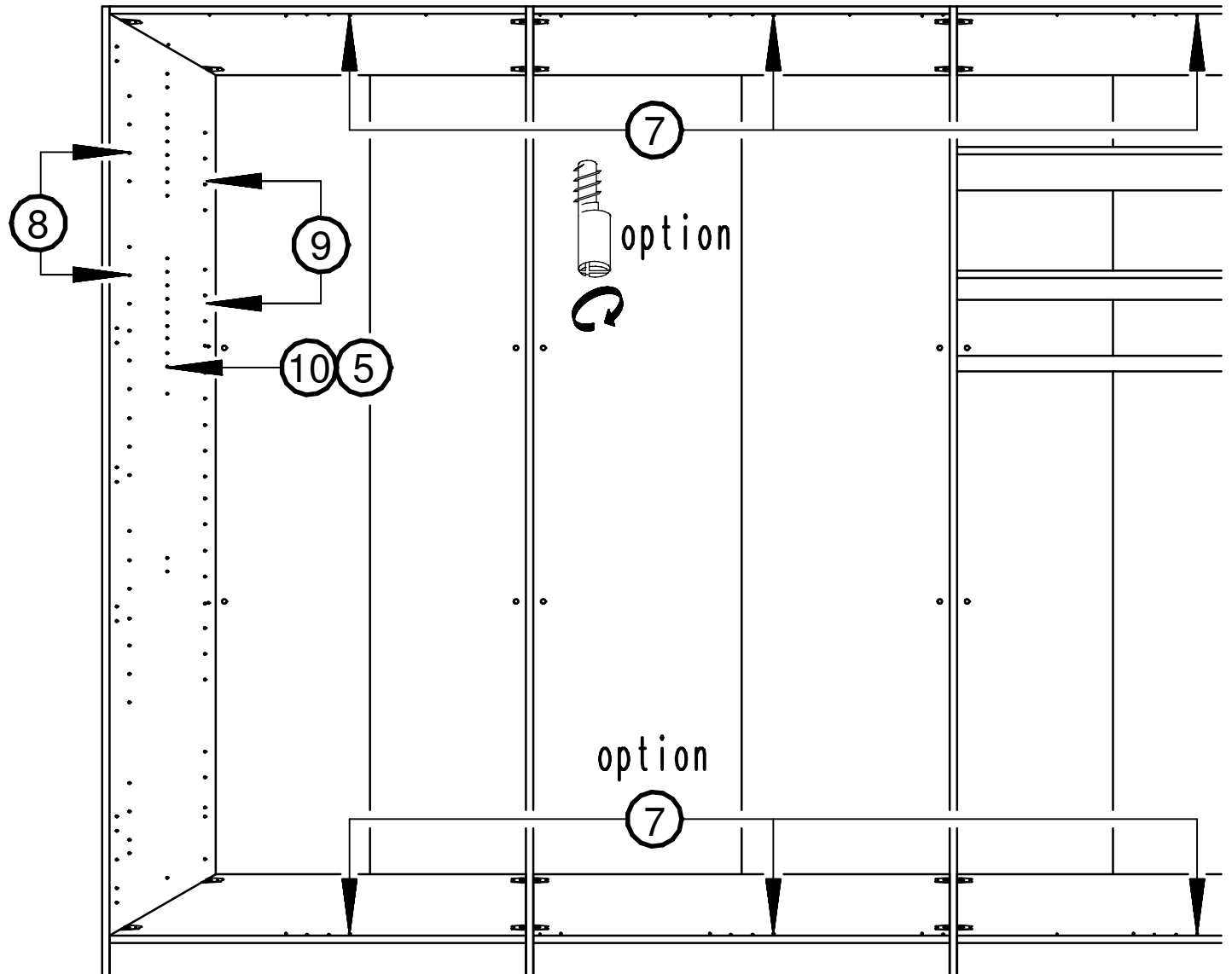

5.

621.0090.000

621.0091.000

631.1063.000
4 x 35 mm



11

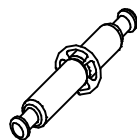

12

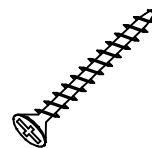

13

option

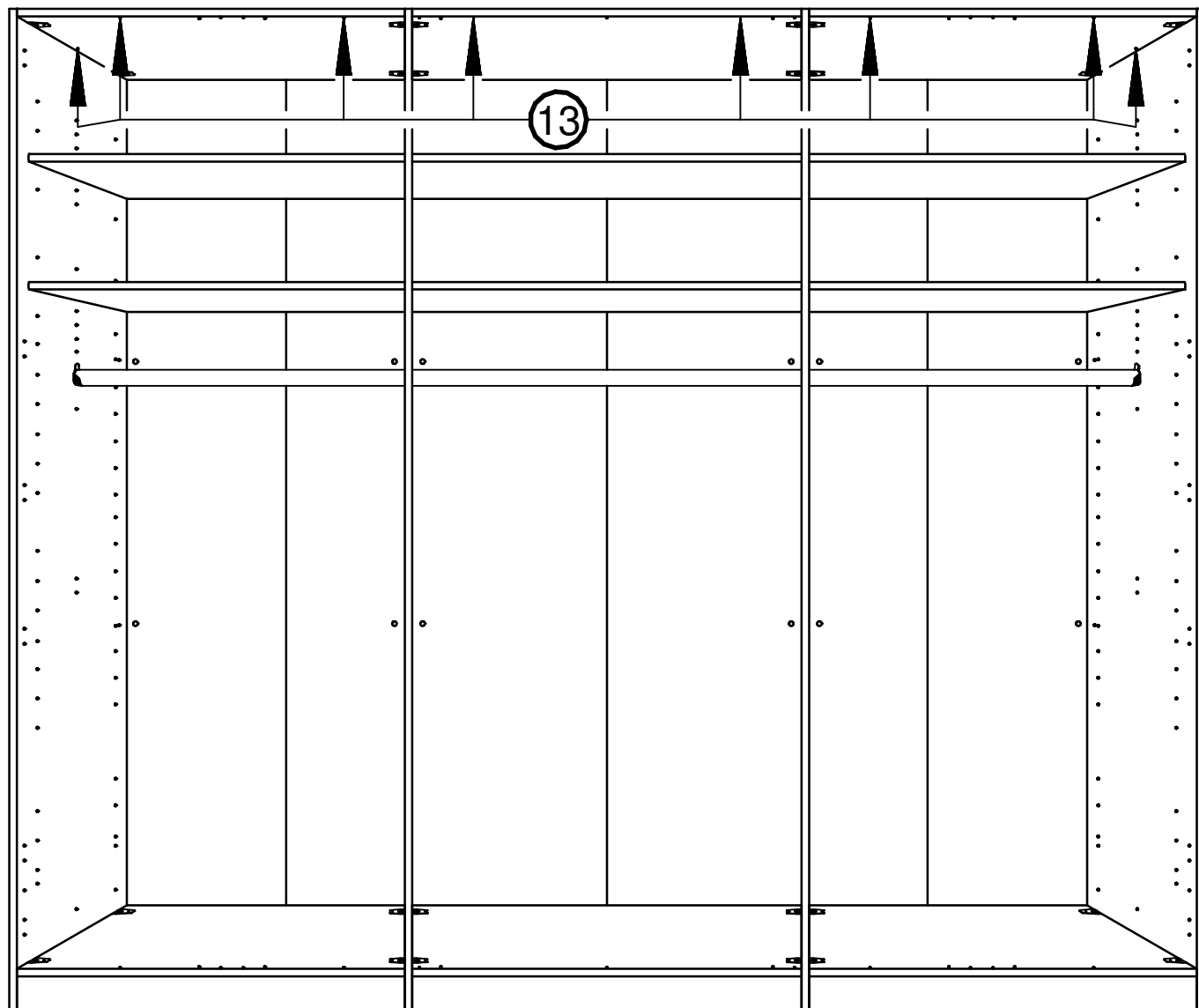
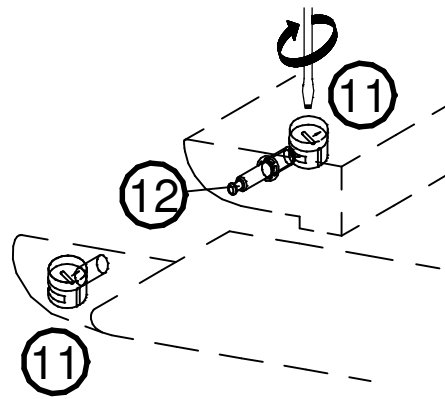

6.

621.2209.000

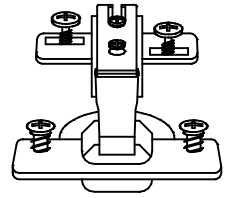

14

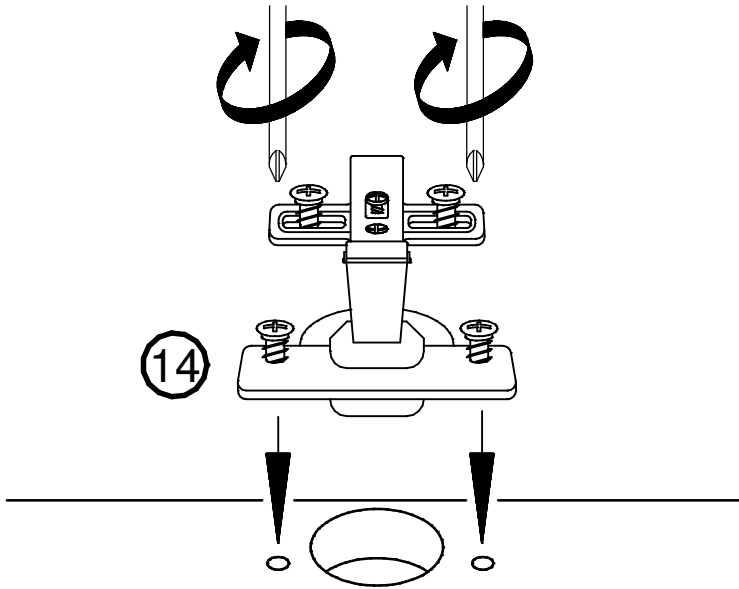

option 3x 14

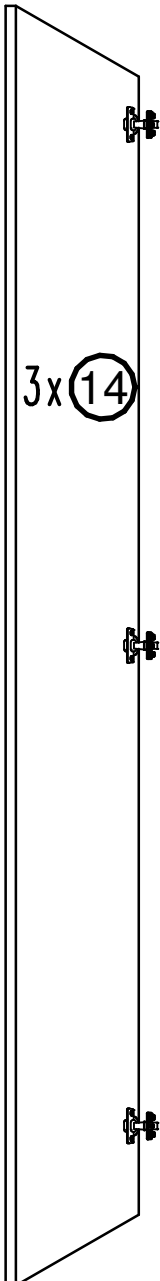

4x 14

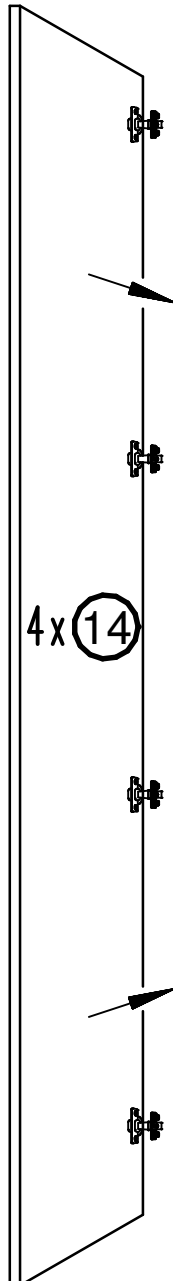

7.

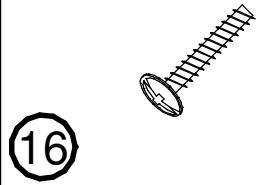
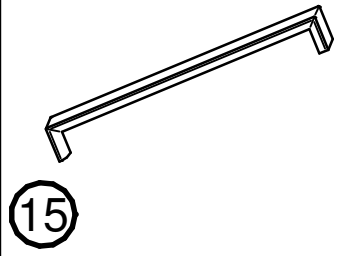
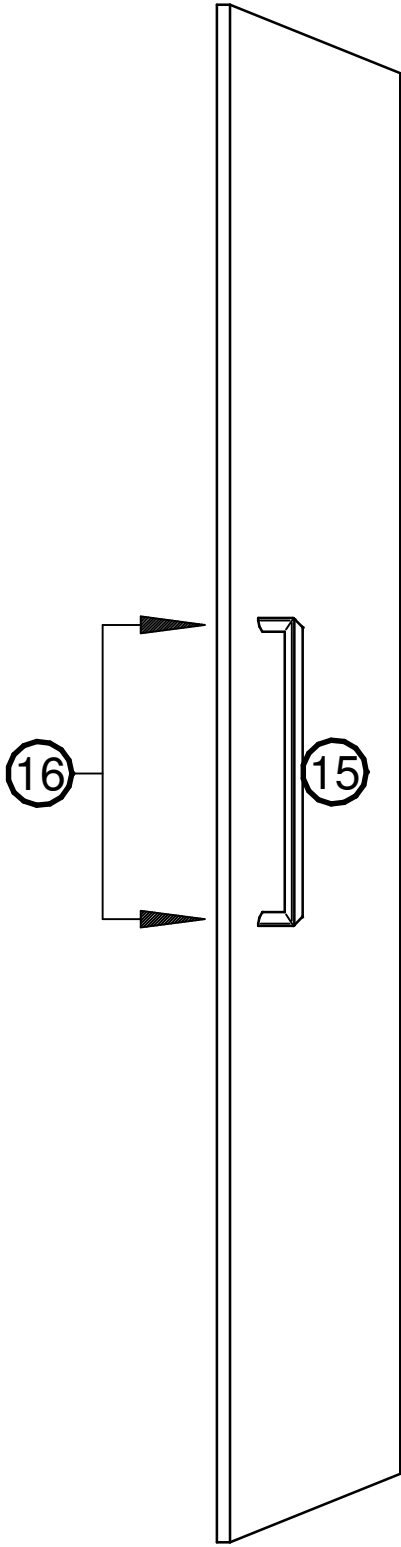

option

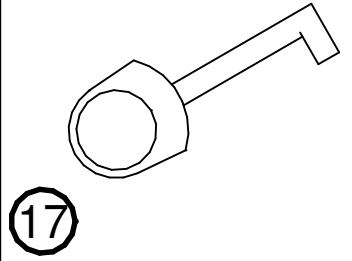

8.

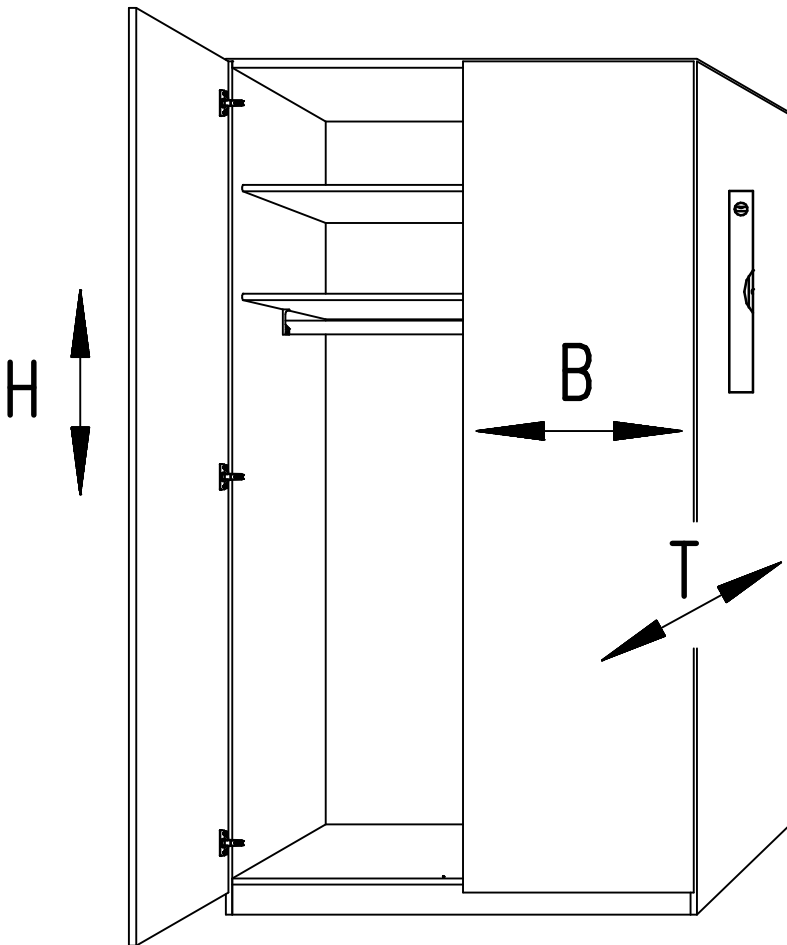
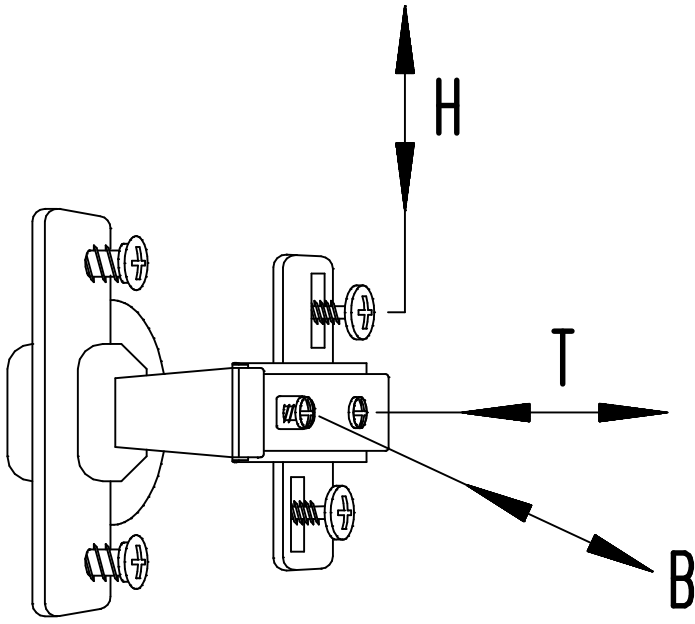

Montageanleitung

Assembly Instructions

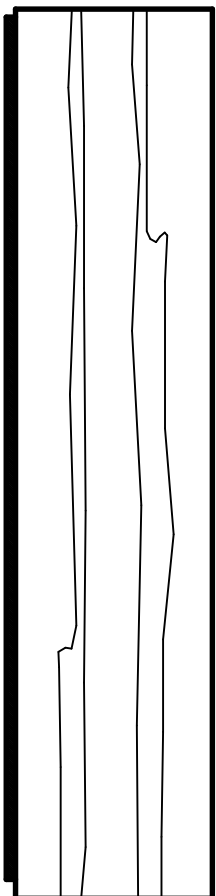
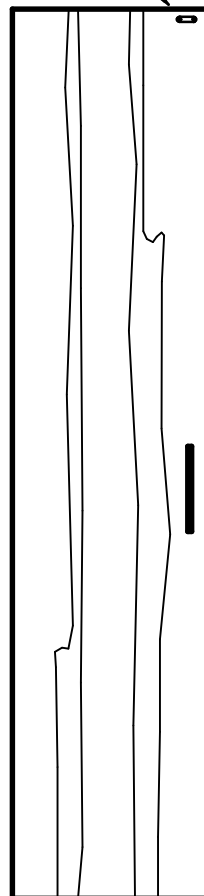
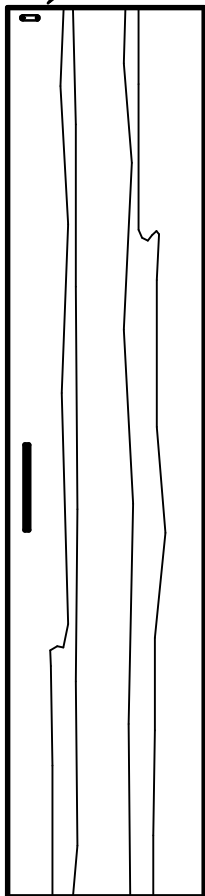
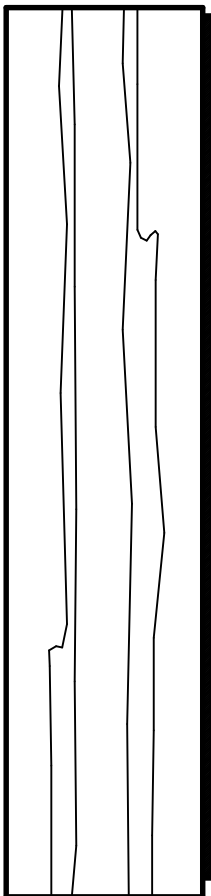
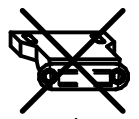
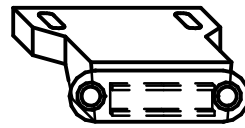
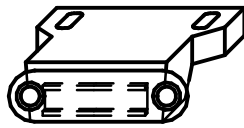
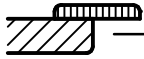
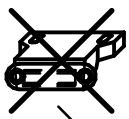
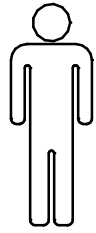
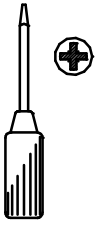

631.1472.000
3,5 x 15 mm



①

641.0129.000

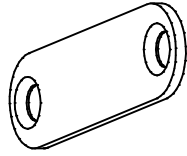

②

1.

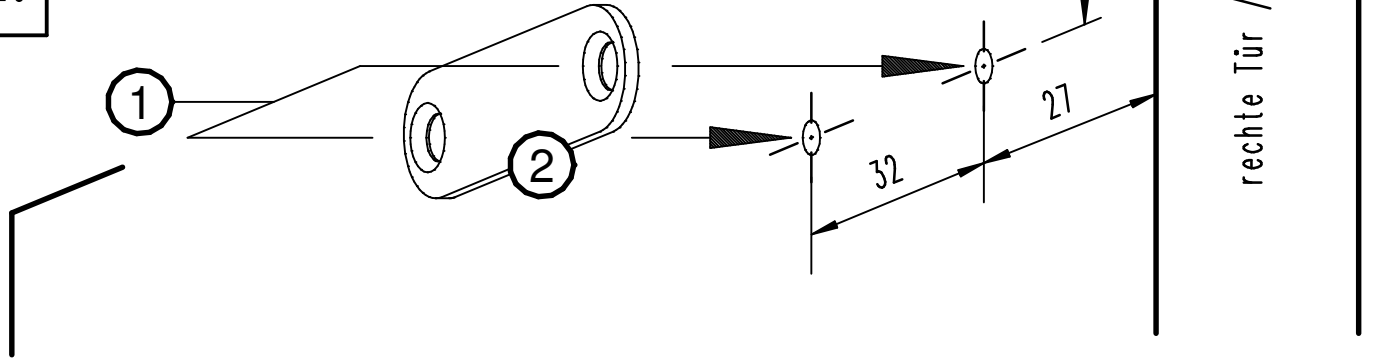

631.1070.000
3 x 15 mm



③

641.0128.000

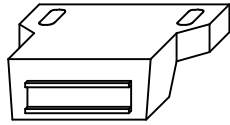

④

2.

