

CARDOSO
1311-13(FIX)+
2520(FIX)+
4010(FIX)+
6021-23(FIX)+7300

- | | | | |
|-----------|--------------------------------------------------------|-----------|-----------------------------------------------------|
| D | MONTAGEANLEITUNG
BEDIENUNGSANLEITUNG | GB | ASSEMBLY INSTRUCTIONS
INSTRUCTION MANUAL |
| NL | HANDLEIDING VOOR DE MONTAGE
GEBRUIKSAANWIJZING | PL | INSTRUKCJA MONTAŻU
INSTRUKCJA OBSŁUGI |
| TR | MONTAJ TALIMATI
KULLANIM KLAVUZU | RU | ИНСТРУКЦИЯ ПО МОНТАЖУ
ИНСТРУКЦИЯ ПО ЭКСПЛУАТАЦИИ |
| RO | INSTRUCȚIUNI DE INSTALARE
INSTRUCȚIUNI DE UTILIZARE | IT | ISTRUZIONI DI MONTAGGIO
MANUALE DI ISTRUZIONI |
| FR | NOTICE DE MONTAGE
MANUEL INSTRUCTIONS | SK | MONTÁŽNY NÁVOD
NÁVOD NA POUŽITIE |
| HU | SZERELÉSI UTASÍTÁSOK
KEZELÉSI UTASÍTÁS | CZ | MONTÁŽNÍ NÁVOD
NÁVOD K POUŽITÍ |
| SI | NAVODILA ZA MONTAŽO
NAVODILA ZA UPORABO | PT | INSTRUÇÕES DE MONTAGEM
MANUAL DO USUÁRIO |
| ES | INSTRUCCIONES DE MONTAJE
MANUAL DEL USUARIO | HR | UPUTE ZA MONTAŽU
UPUTE ZA UPOTREBU |

Name · Naam · Nazwa · Isim · Название · Nume · Nome · Názov · Názov ·
 Název · Neve

CARDOSO

Typ · Type · Tip · Тип · Tipo · Típus

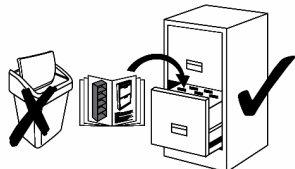
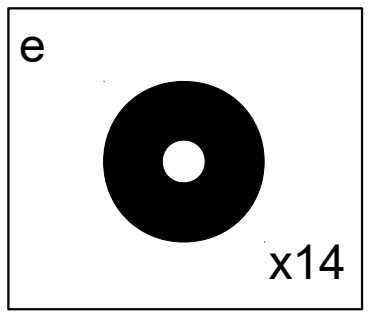
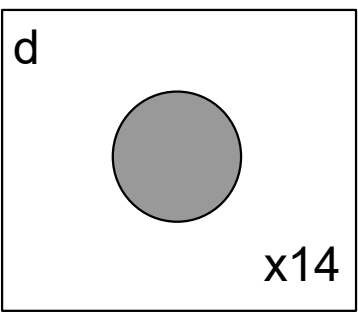
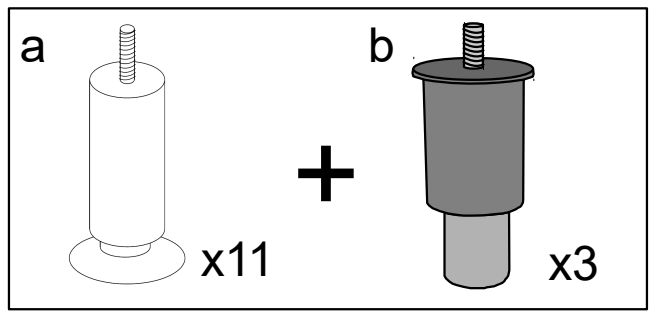
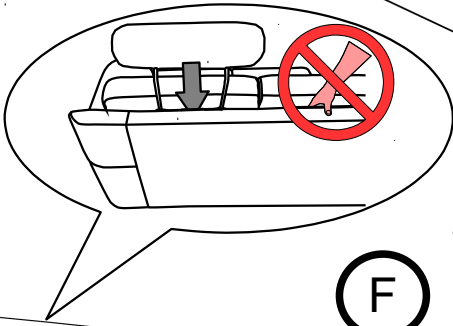
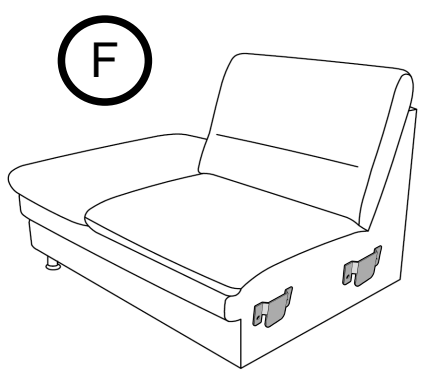
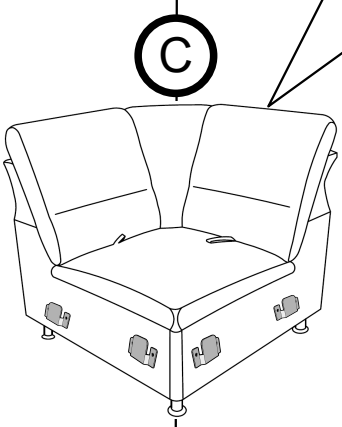
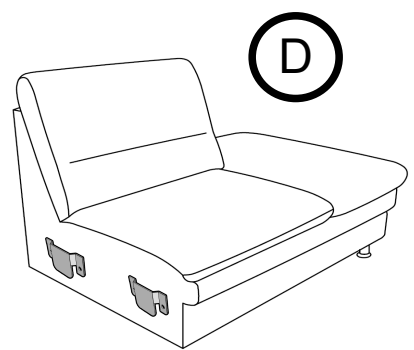
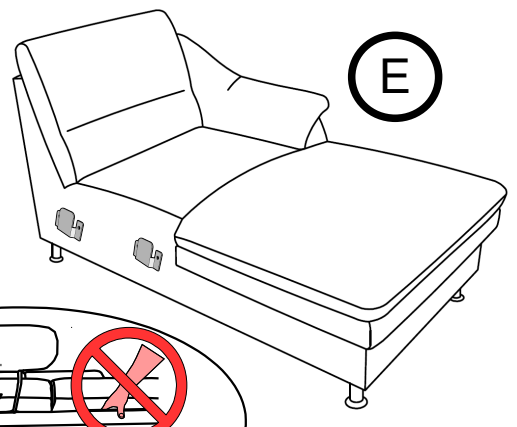
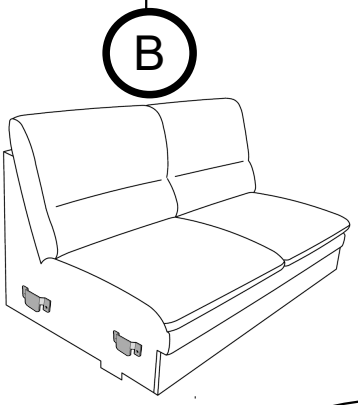
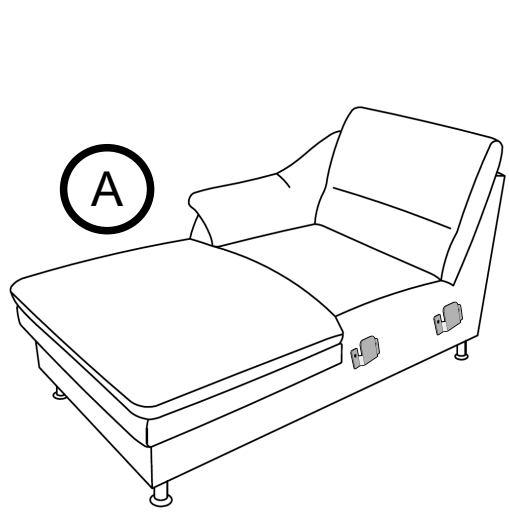
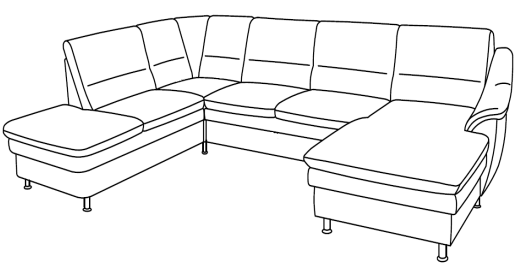
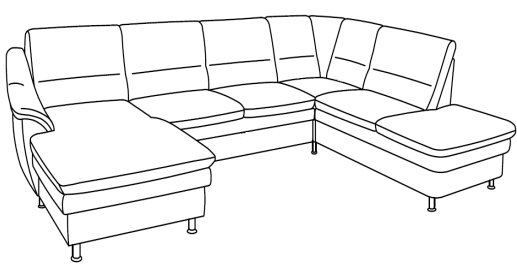
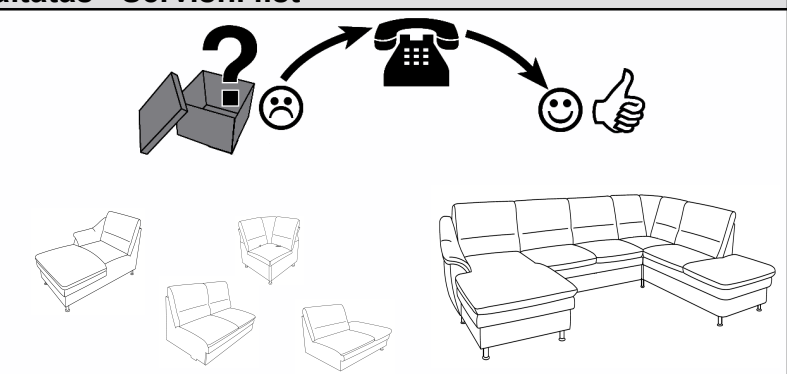

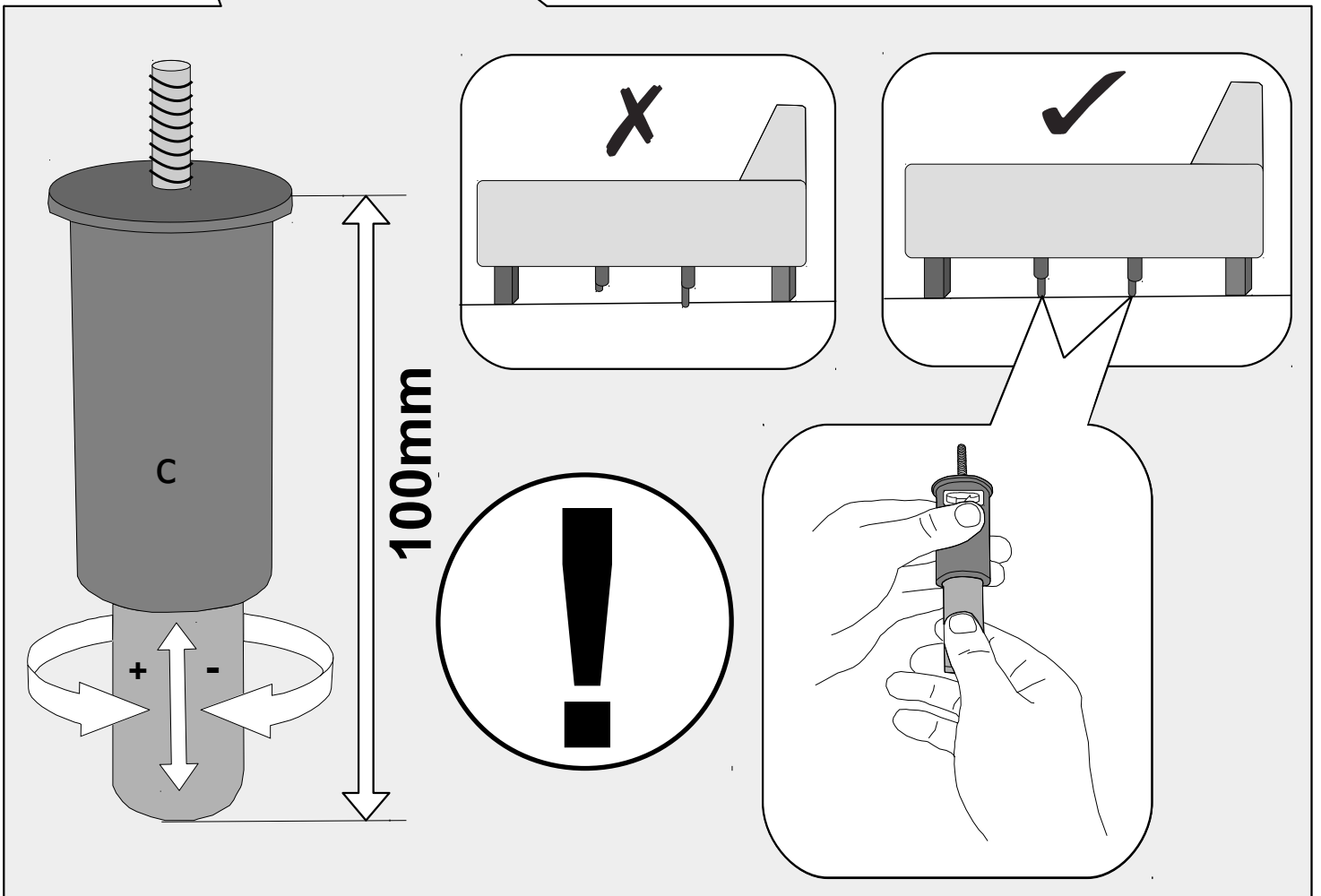
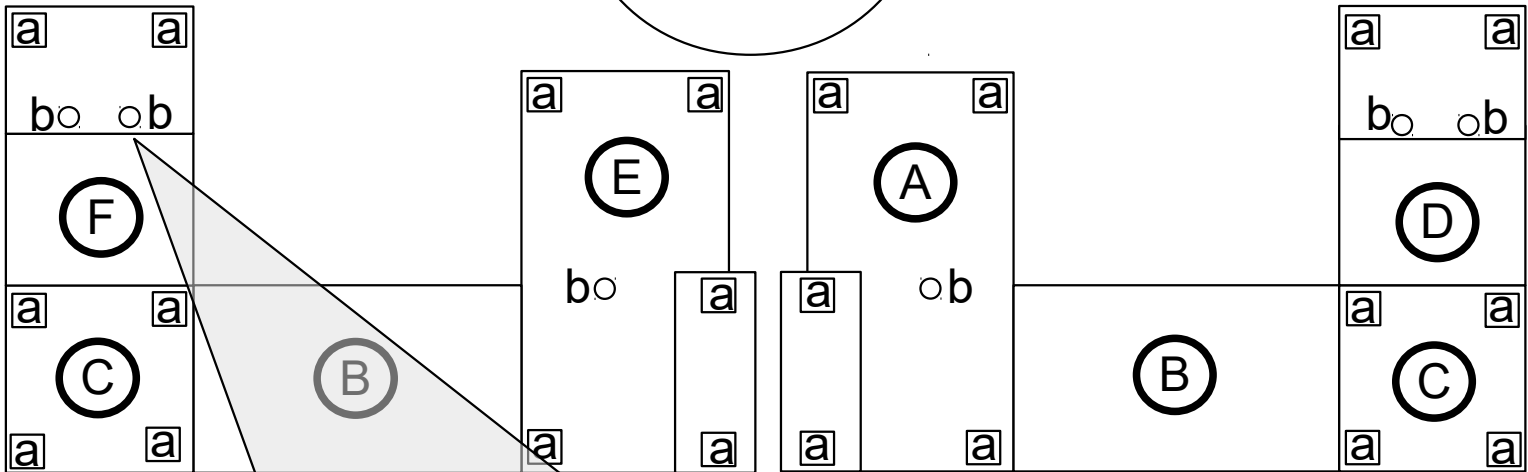
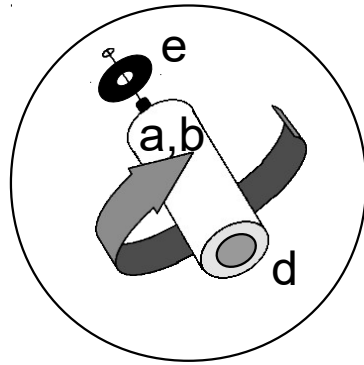
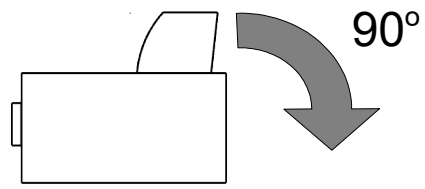

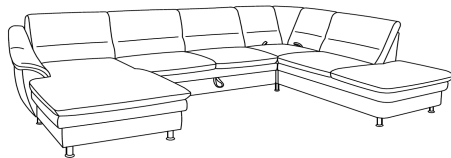
1

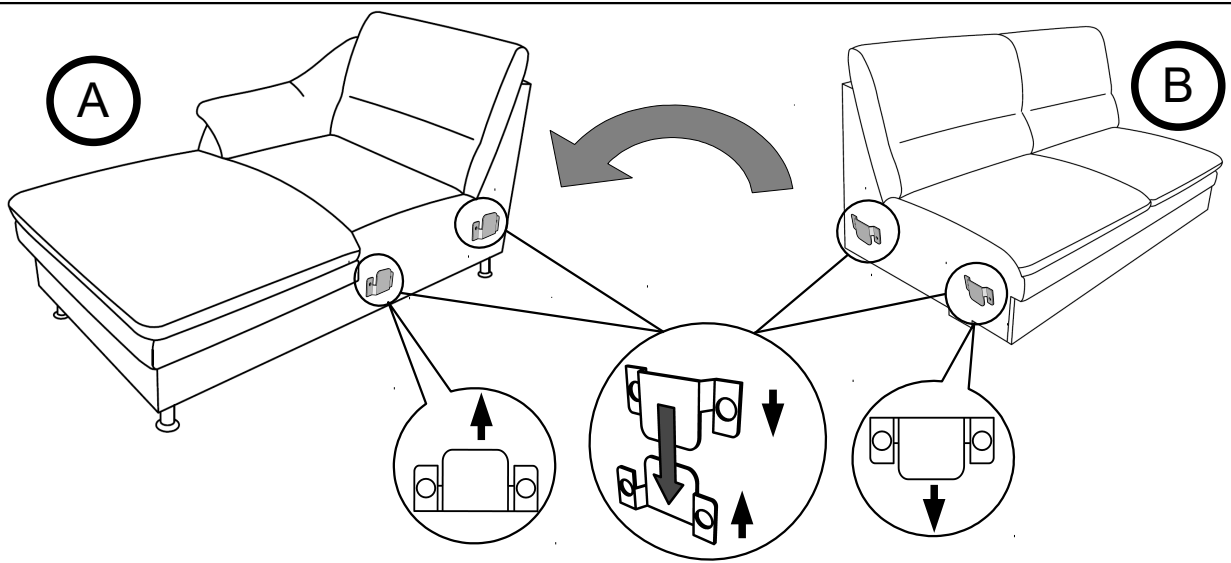

2

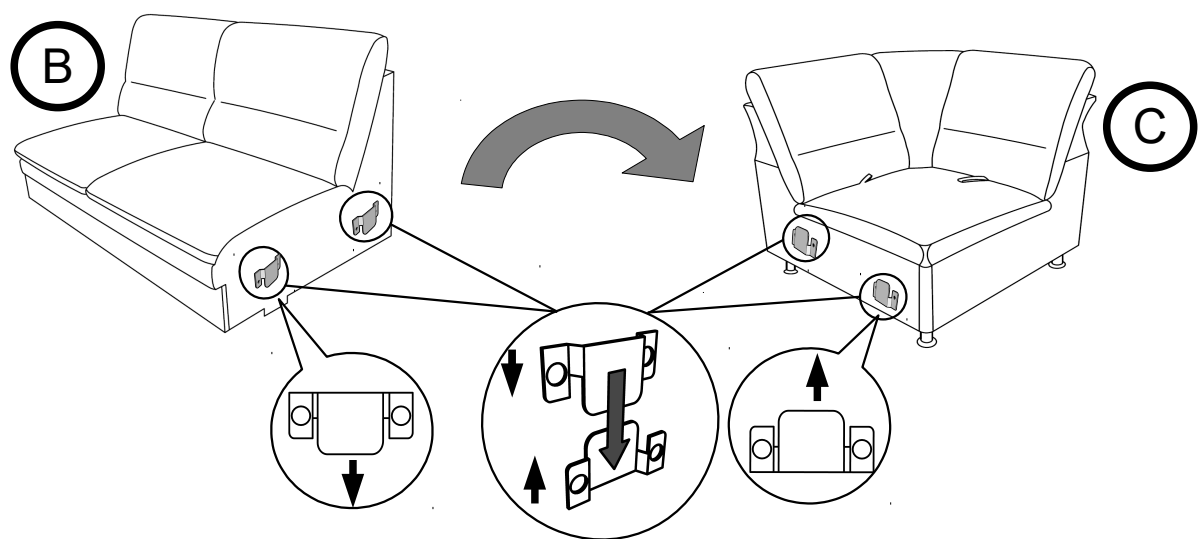

3

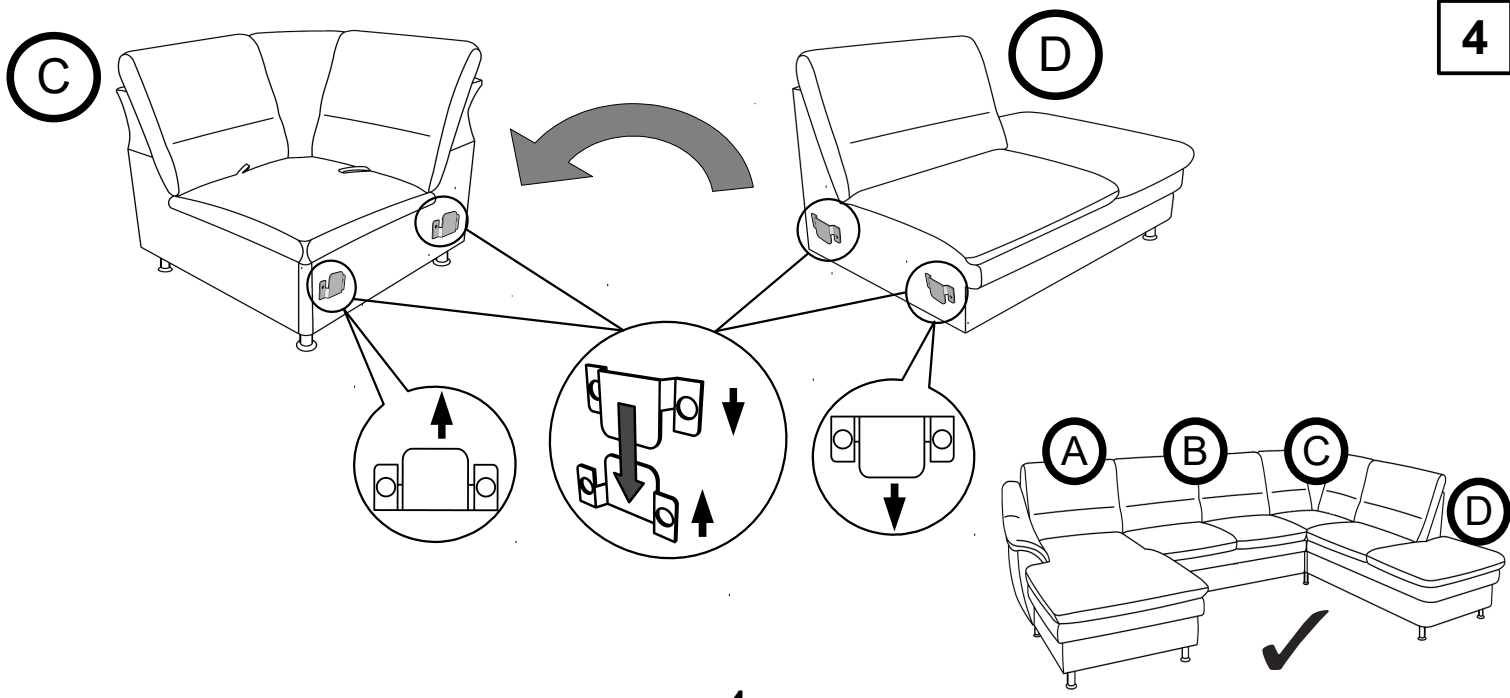

4

5

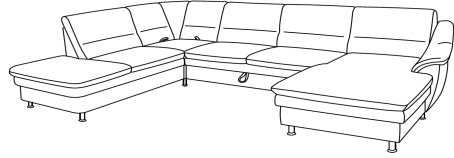

6

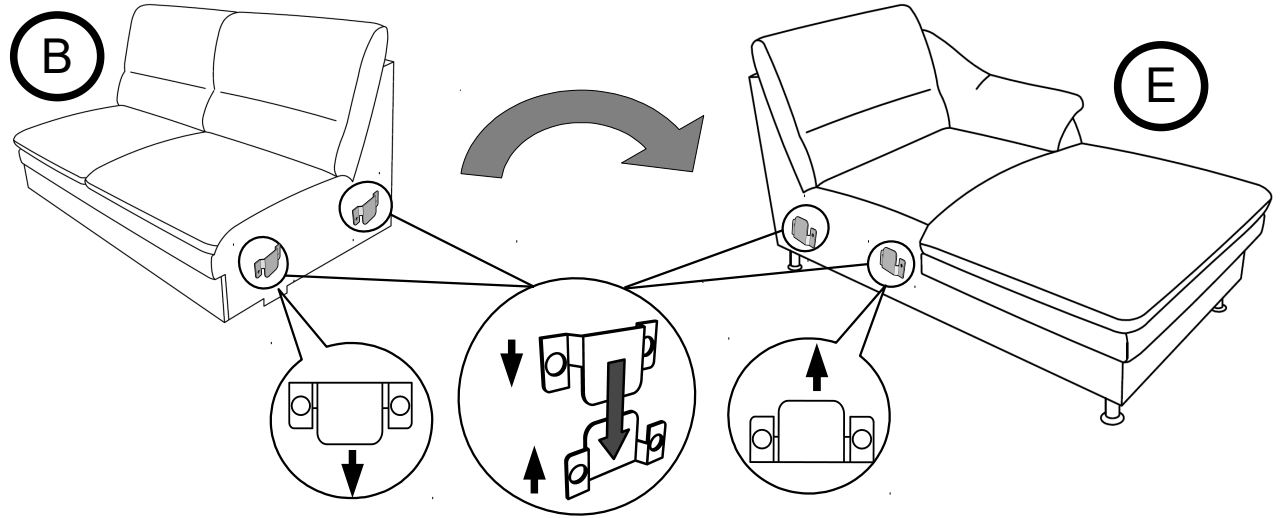

7

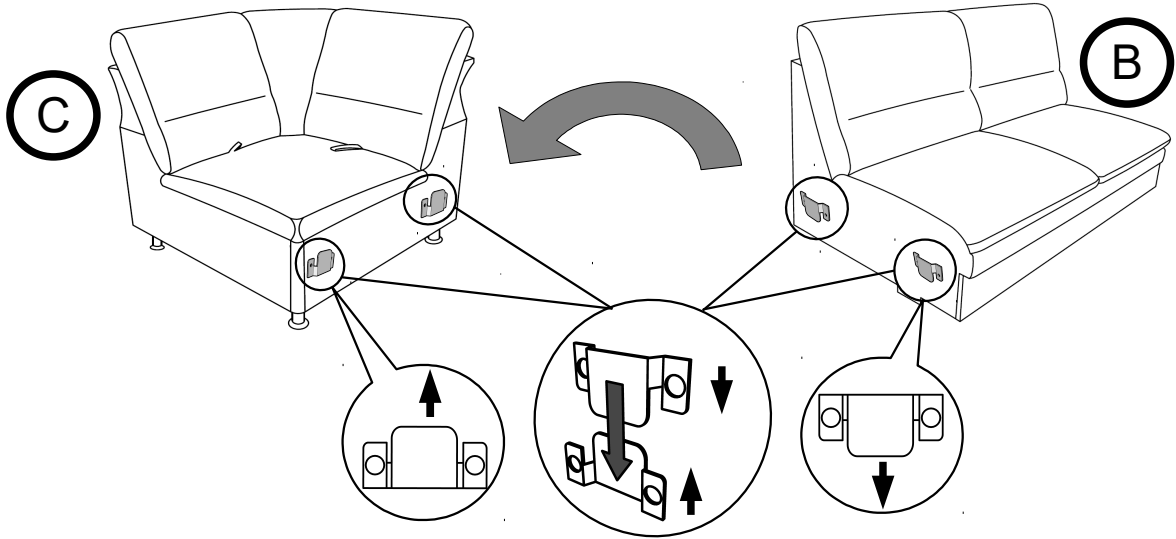

8

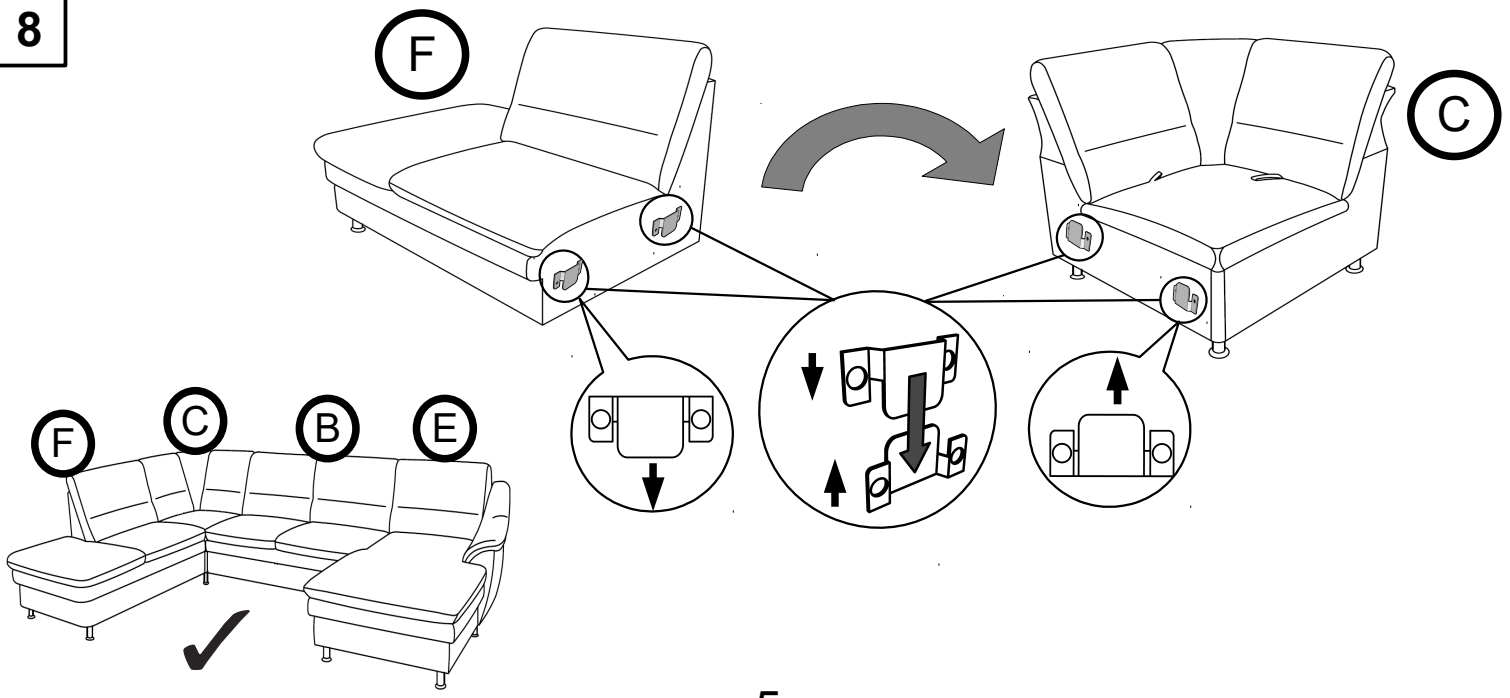

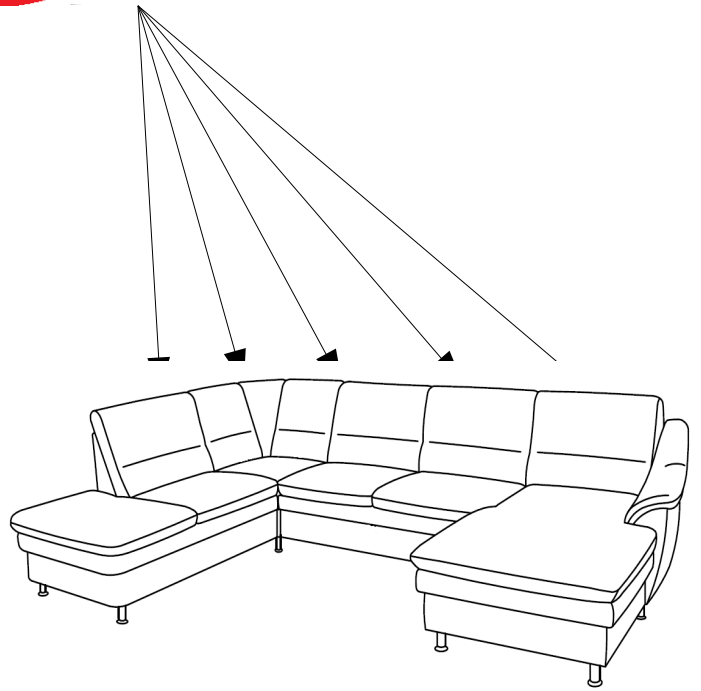
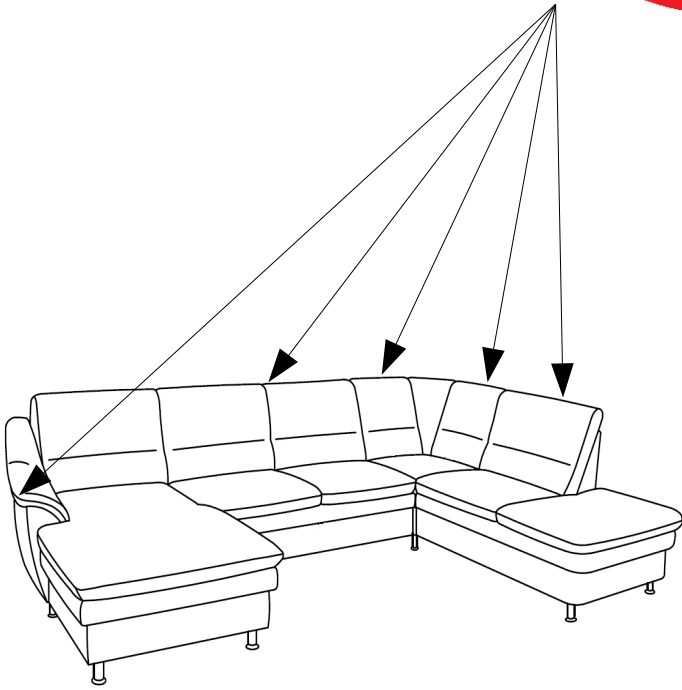

Name · Naam · Nazwa · Ísim · Название · Nume · Nome · Názov · Názov · Název · Neve
CARDOSO
Typ · Type · Tip · Тип · Tipo · Típus
7300

