

Sabrina

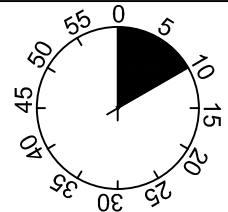

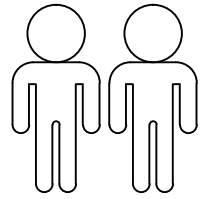

1

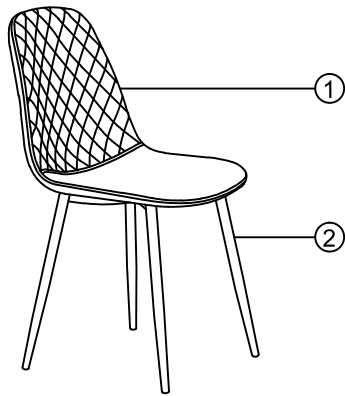
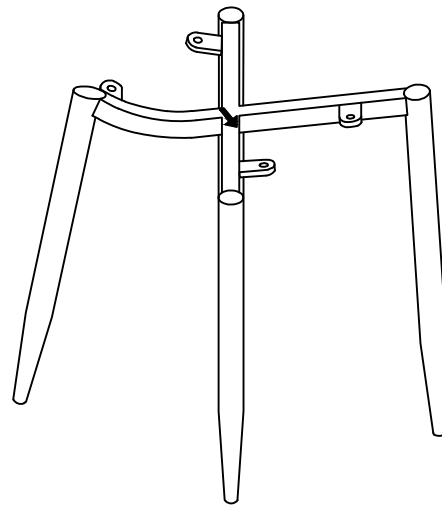
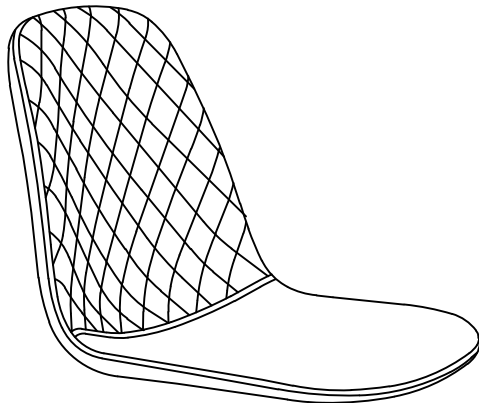

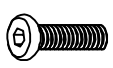

2

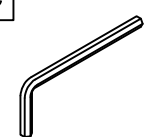

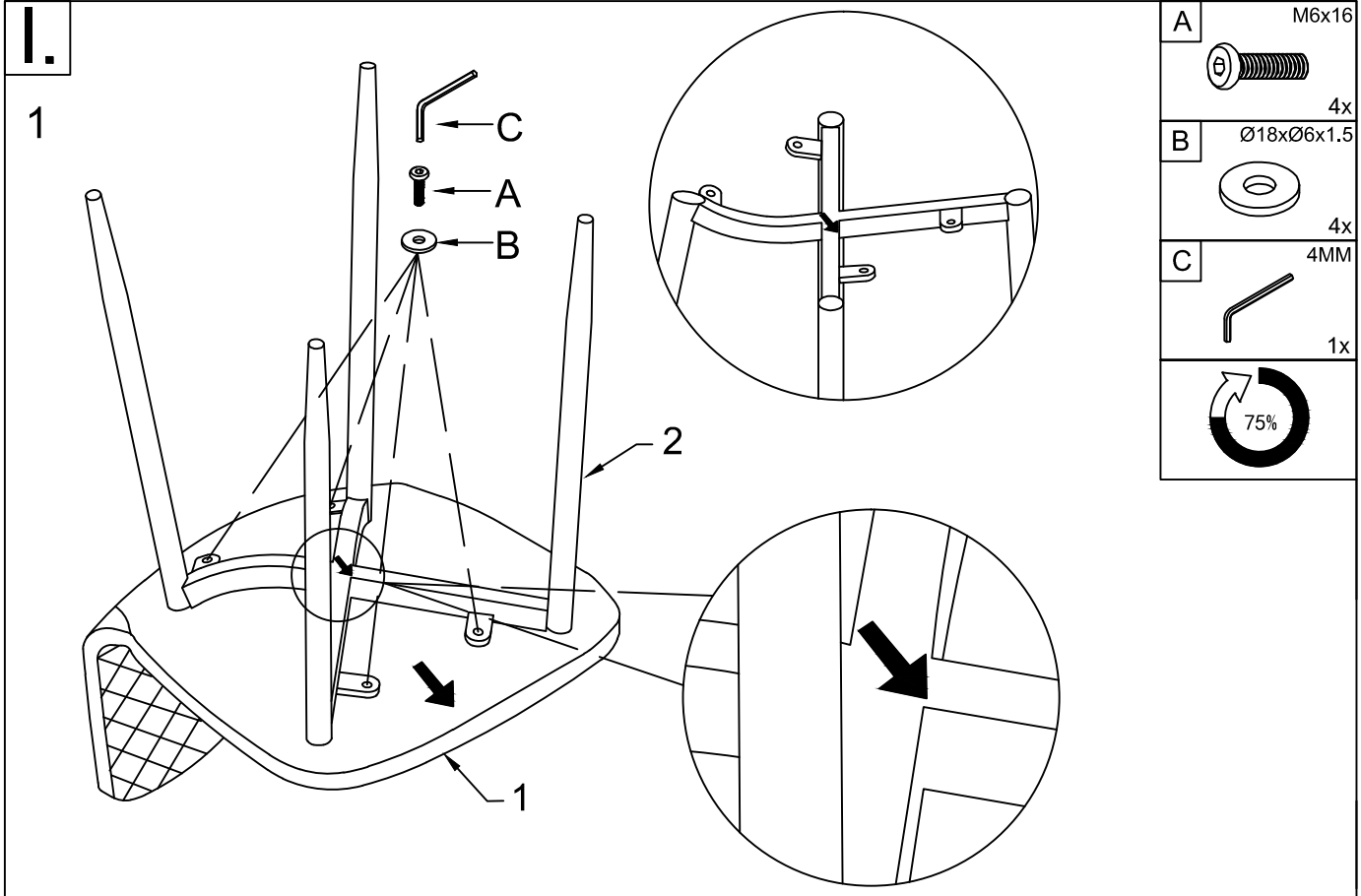
1	1X
2	1X

<p>A M6x16</p>  <p>4x</p>	<p>B Ø18xØ6x1.5</p>  <p>4x</p>	<p>C 4MM</p>  <p>1x</p>
---	--	---



- A M6x16

 4x
 - B $\varnothing 18 \times \varnothing 6 \times 1.5$

 4x
 - C 4MM

 1x
- 



- C 4MM

 1x
- 