

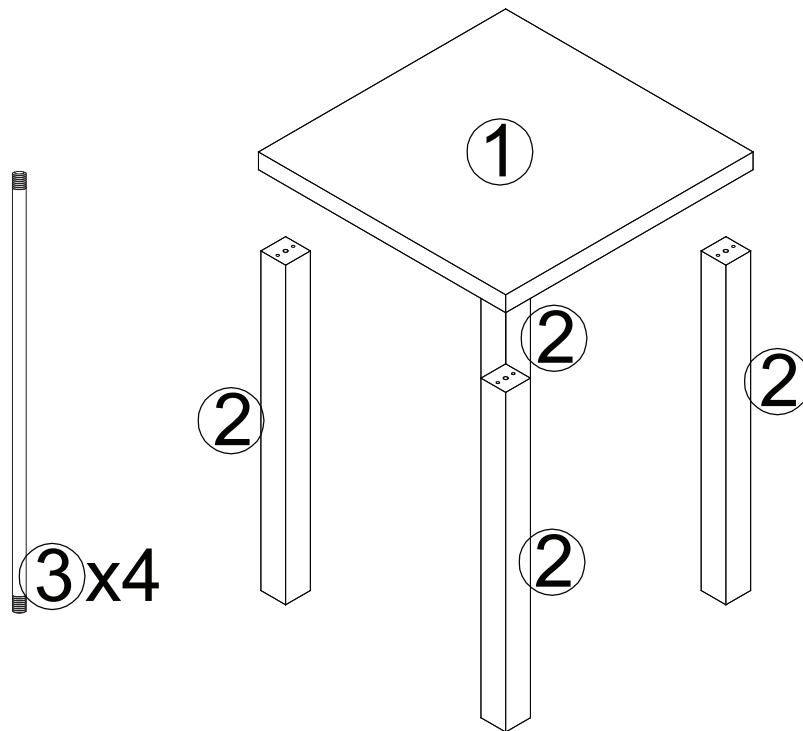

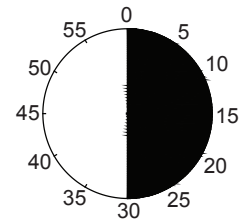

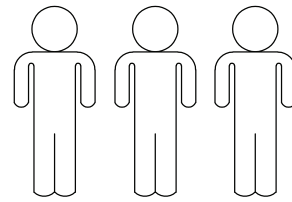

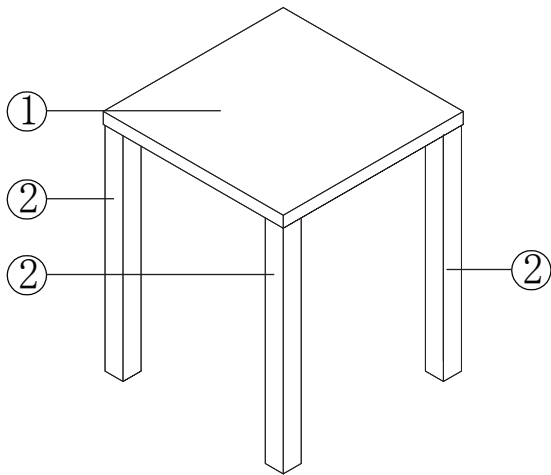



OLGA 2



		
1	1x	1/2
2	4x	2/2
3	4x	2/2



	2/2				
A	∅8x40	B		C	M8
	8x		1x		4x
				D	∅8.5x∅25x2
					4x
				E	M8
					1x

I.
1

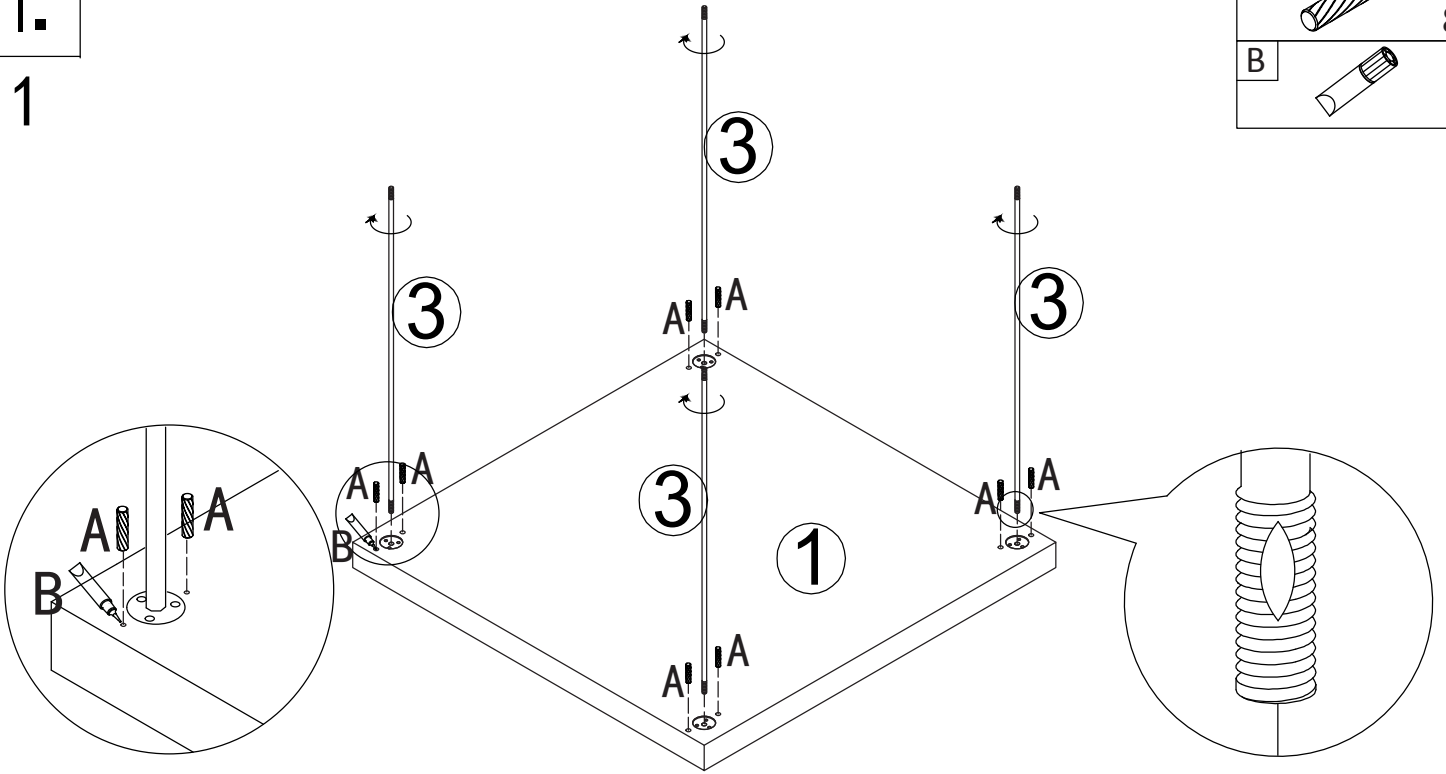
A		ø8x40 8x
B		



2

C		M8 4x
D		ø8. 5xø 25x2 4x
E		M8 1x

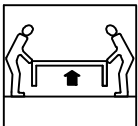
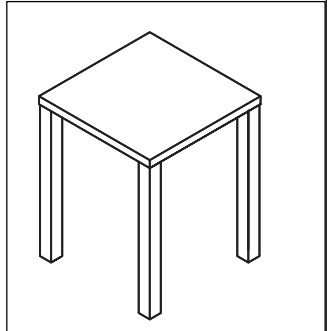
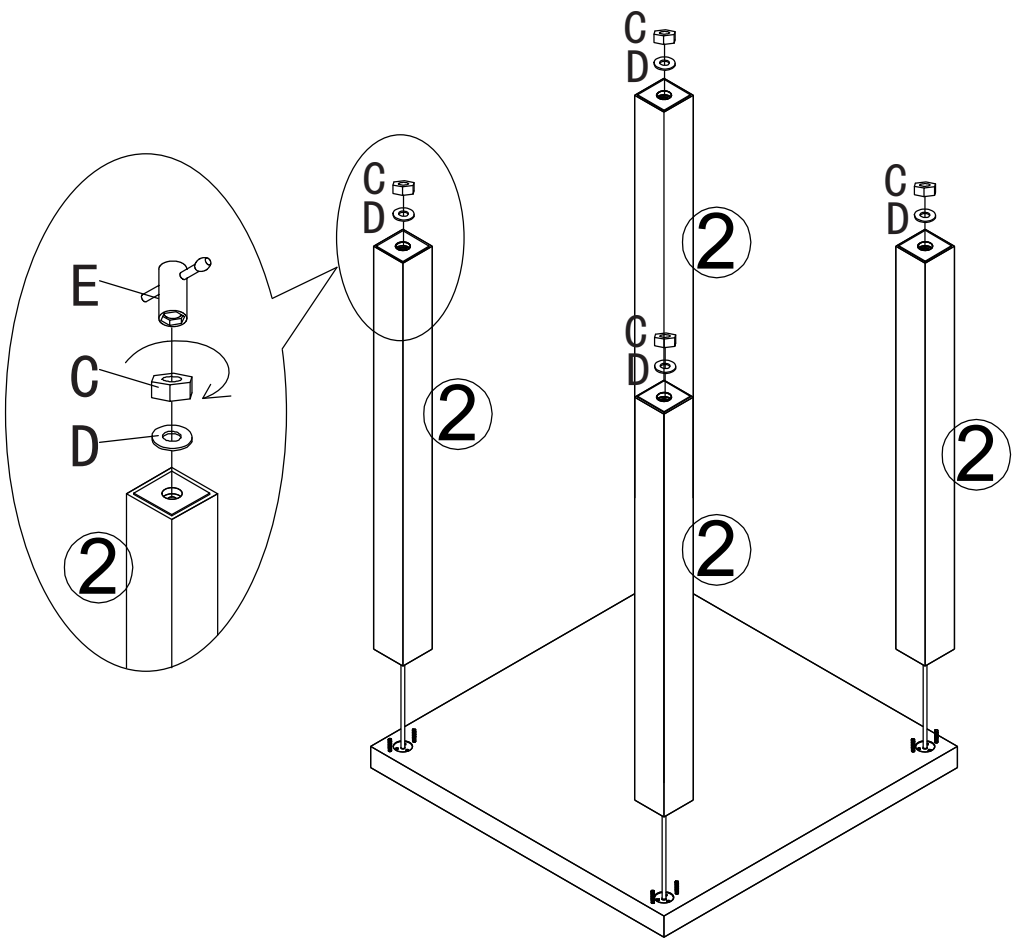

LE TRI
+ FACILE



Séparez les éléments avant de trier