

1.

M2514_01

rauch

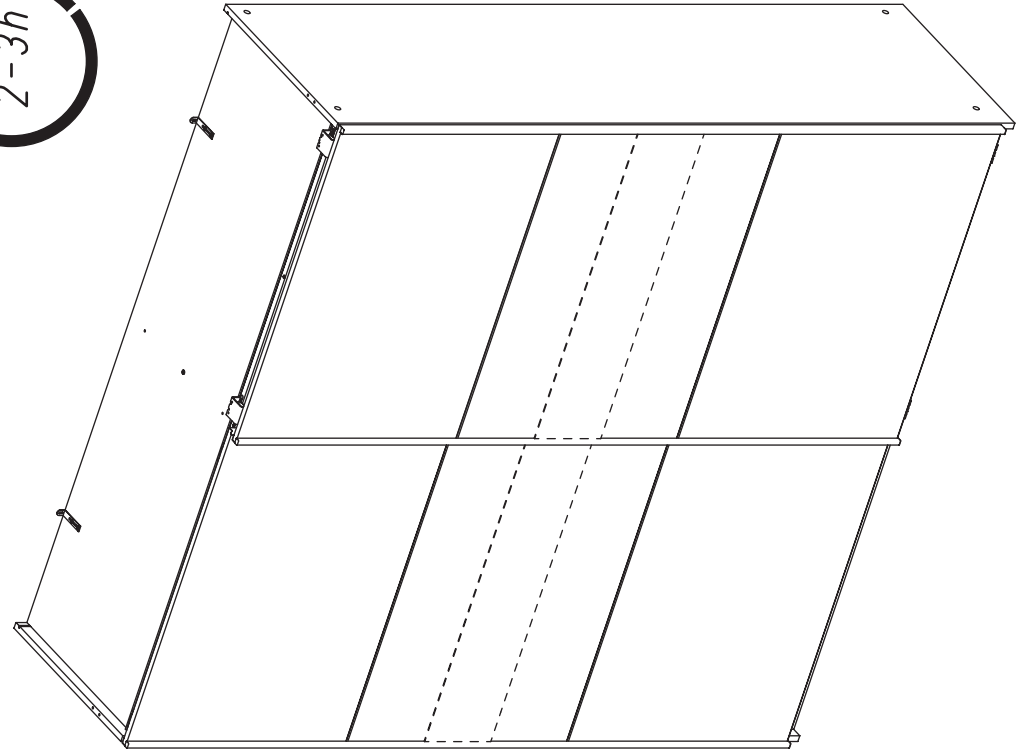
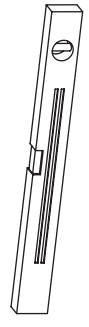
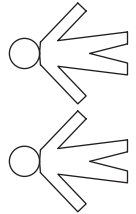
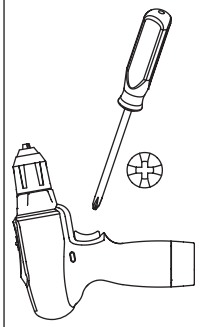

2.

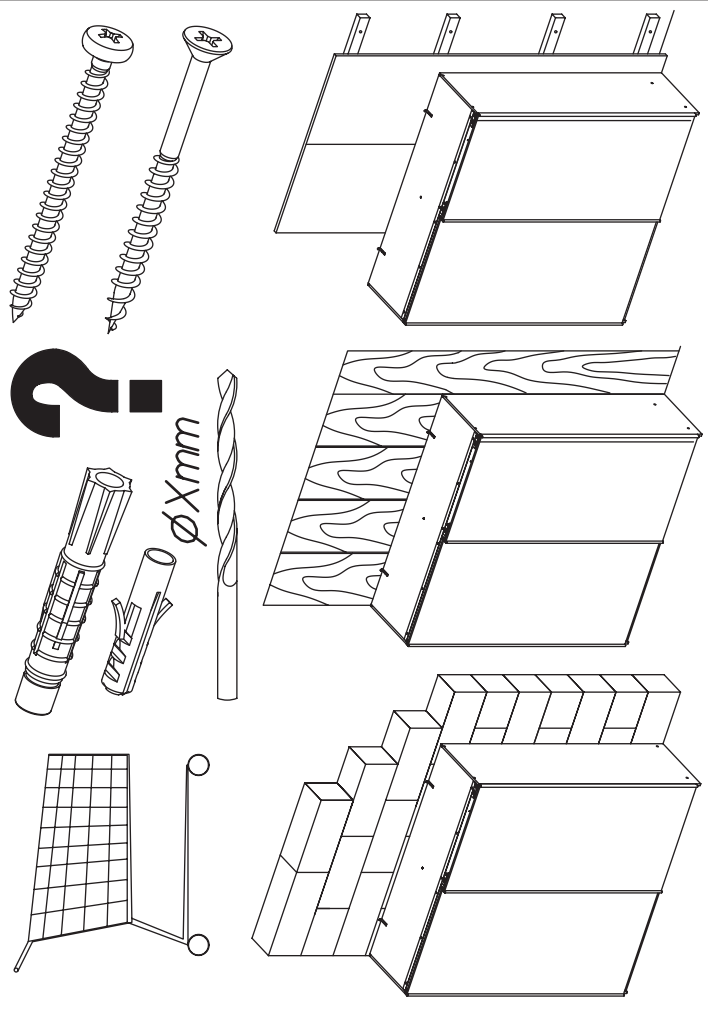
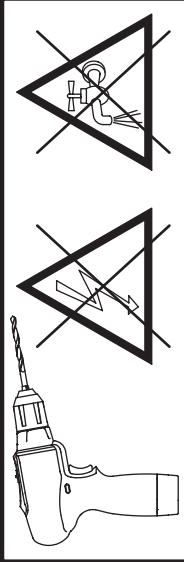
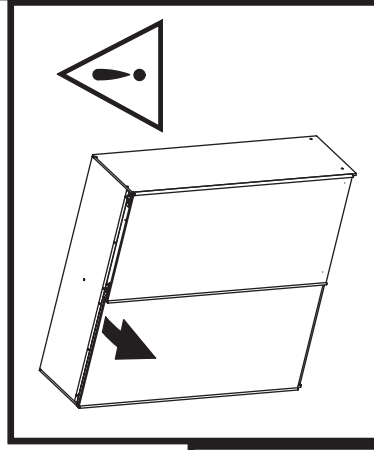
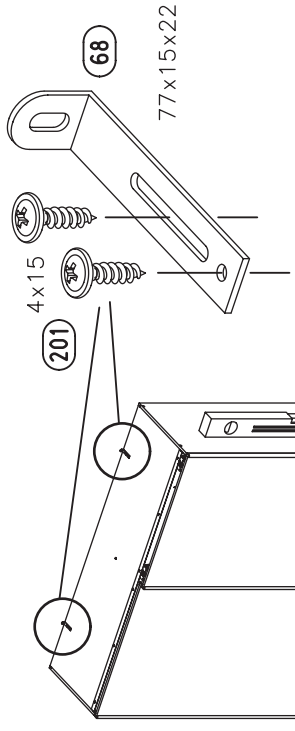

M2514



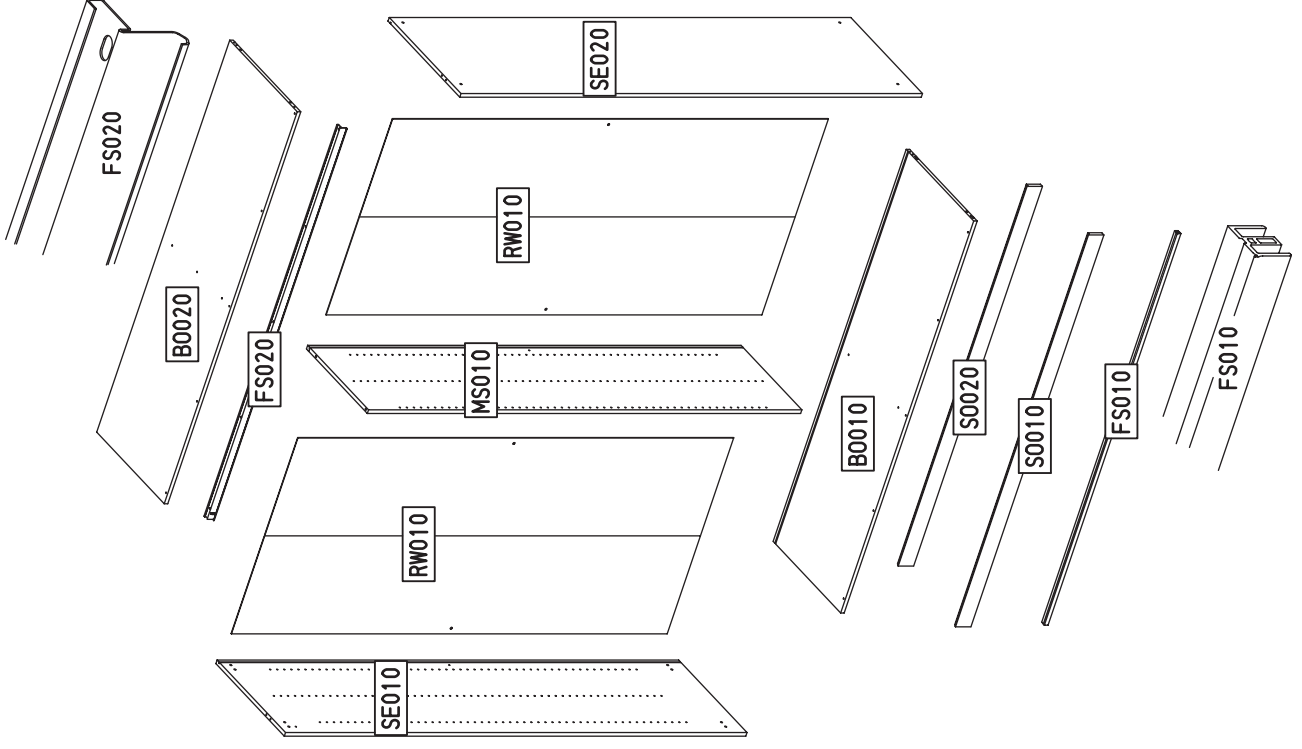



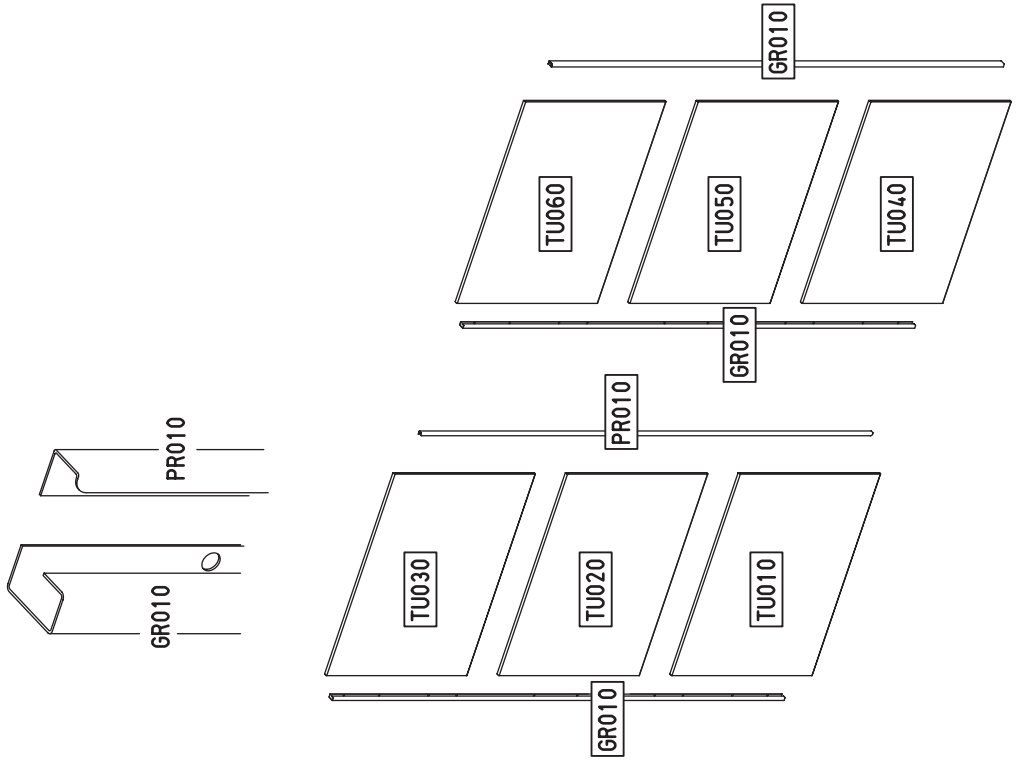



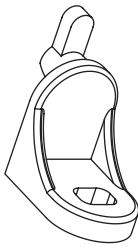

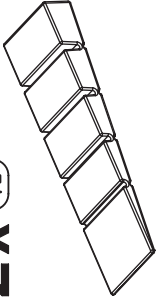

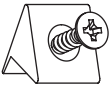
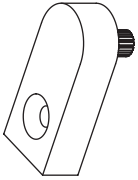
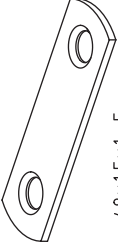

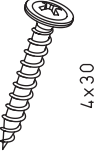

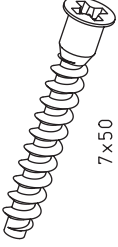
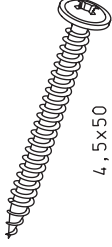





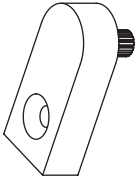

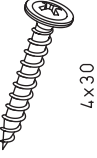

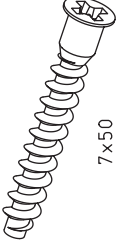
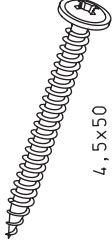





















































































































































































4.



3.



5.

4x ^①	11	2x ^⑫
		
8x ^⑮	8x ^{④⑤}	2x ^⑮
		
4x ^⑮	6x ^⑮	5x ^⑮
		
27x ^⑮	8x ^⑮	1x ^⑮
		
2x ^⑮	4x ^⑮	4x ^⑮
		
4x ^⑮	40x ^⑮	2x ^⑮
		
4x ^⑮	2x ^⑮	2x ^⑮
		
2x ^⑮	8x ^⑮	1x ^⑮
		
2x ^⑮	2x ^⑮	2x ^⑮
		
2x ^⑮	2x ^⑮	2x ^⑮
		
2x ^⑮	2x ^⑮	2x ^⑮
		
2x ^⑮	2x ^⑮	2x ^⑮
		
2x ^⑮	2x ^⑮	2x ^⑮
		
2x ^⑮	2x ^⑮	2x ^⑮
		
2x ^⑮	2x ^⑮	2x ^⑮
		
2x ^⑮	2x ^⑮	2x ^⑮
		
2x ^⑮	2x ^⑮	2x ^⑮
		
2x ^⑮	2x ^⑮	2x ^⑮
		
2x ^⑮	2x ^⑮	2x ^⑮
		
2x ^⑮	2x ^⑮	2x ^⑮
		
2x ^⑮	2x ^⑮	2x ^⑮
		
2x ^⑮	2x ^⑮	2x ^⑮
		
2x ^⑮	2x ^⑮	2x ^⑮
		
2x ^⑮	2x ^⑮	2x ^⑮
		
2x ^⑮	2x ^⑮	2x ^⑮
		
2x ^⑮	2x ^⑮	2x ^⑮
		
2x ^⑮	2x ^⑮	2x ^⑮
		
2x ^⑮	2x ^⑮	2x ^⑮
		
2x ^⑮	2x ^⑮	2x ^⑮
		
2x ^⑮	2x ^⑮	2x ^⑮
		
2x ^⑮	2x ^⑮	2x ^⑮
		
2x ^⑮	2x ^⑮	2x ^⑮
		
2x ^⑮	2x ^⑮	2x ^⑮
		
2x ^⑮	2x ^⑮	2x ^⑮
		
2x ^⑮	2x ^⑮	2x ^⑮
		
2x ^⑮	2x ^⑮	2x ^⑮
		
2x ^⑮	2x ^⑮	2x ^⑮
		
2x ^⑮	2x ^⑮	2x ^⑮
		
2x ^⑮	2x ^⑮	2x ^⑮
		
2x ^⑮	2x ^⑮	2x ^⑮
		
2x ^⑮	2x ^⑮	2x ^⑮
		
2x ^⑮	2x ^⑮	2x ^⑮
		
2x ^⑮	2x ^⑮	2x ^⑮
		
2x ^⑮	2x ^⑮	2x ^⑮
		
2x ^⑮	2x ^⑮	2x ^⑮
		
2x ^⑮	2x ^⑮	2x ^⑮
		
2x ^⑮	2x ^⑮	2x ^⑮
		
2x ^⑮	2x ^⑮	2x ^⑮
		
2x ^⑮	2x ^⑮	2x ^⑮
		
2x ^⑮	2x ^⑮	2x ^⑮
		
2x ^⑮	2x ^⑮	2x ^⑮
		
2x ^⑮	2x ^⑮	2x ^⑮
		
2x ^⑮	2x ^⑮	2x ^⑮
		
2x ^⑮	2x ^⑮	2x ^⑮
		
2x ^⑮	2x ^⑮	2x ^⑮
		
2x ^⑮	2x ^⑮	2x ^⑮
		
2x ^⑮	2x ^⑮	2x ^⑮
		
2x ^⑮	2x ^⑮	2x ^⑮
		
2x ^⑮	2x ^⑮	2x ^⑮
		
2x ^⑮	2x ^⑮	2x ^⑮
		
2x ^⑮	2x ^⑮	2x ^⑮
		
2x ^⑮	2x ^⑮	2x ^⑮
		
2x ^⑮	2x ^⑮	2x ^⑮
		
2x ^⑮	2x ^⑮	2x ^⑮
		
2x ^⑮	2x ^⑮	2x ^⑮
		
2x ^⑮	2x ^⑮	2x ^⑮
		
2x ^⑮	2x ^⑮	2x ^⑮
		
2x ^⑮	2x ^⑮	2x ^⑮
		
2x ^⑮	2x ^⑮	2x ^⑮
		
2x ^⑮	2x ^⑮	2x ^⑮
		
2x ^⑮	2x ^⑮	2x ^⑮
		
2x ^⑮	2x ^⑮	2x ^⑮
		
2x ^⑮	2x ^⑮	2x ^⑮

7.

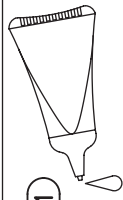

1

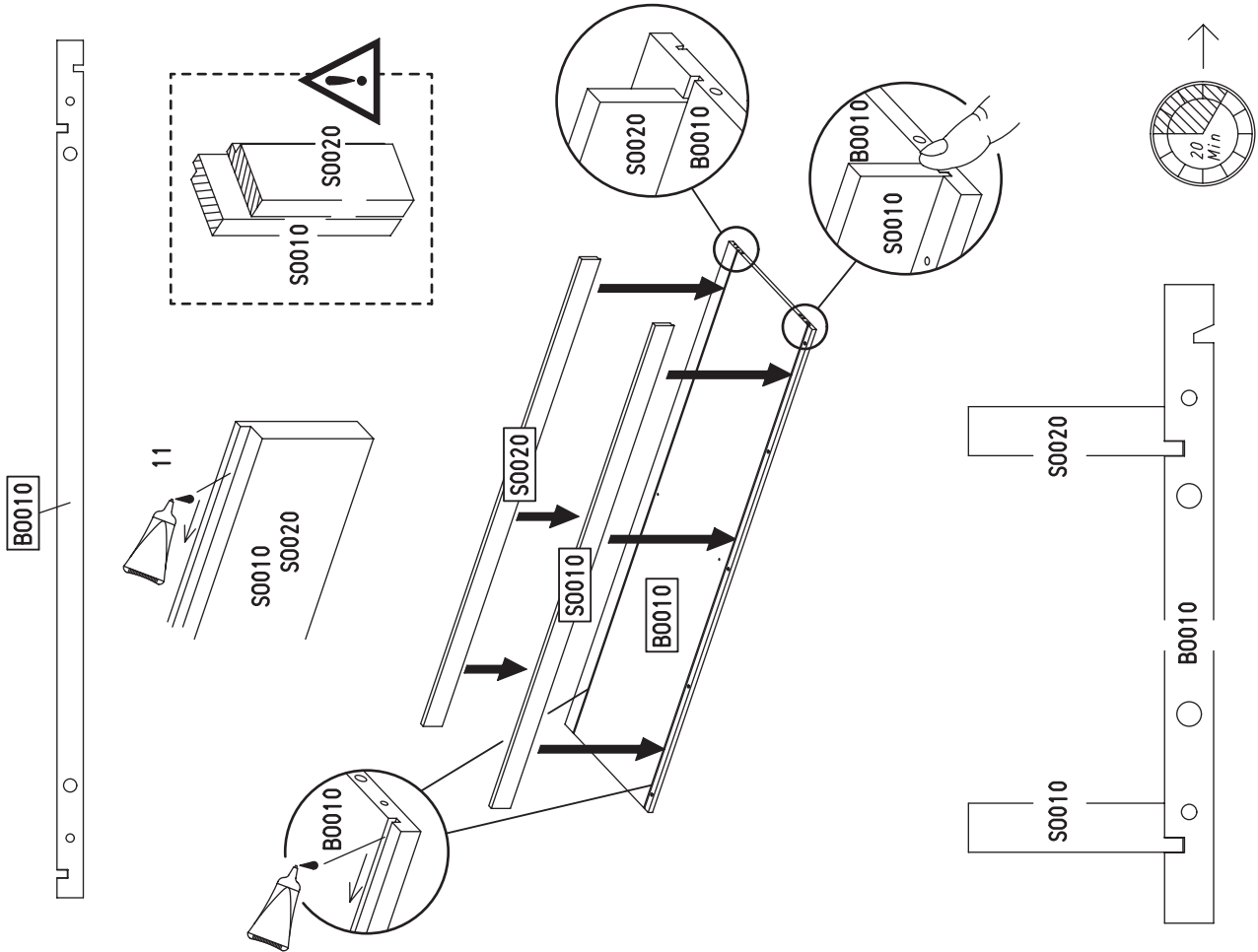

M2514

8.

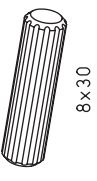

4x 18

2

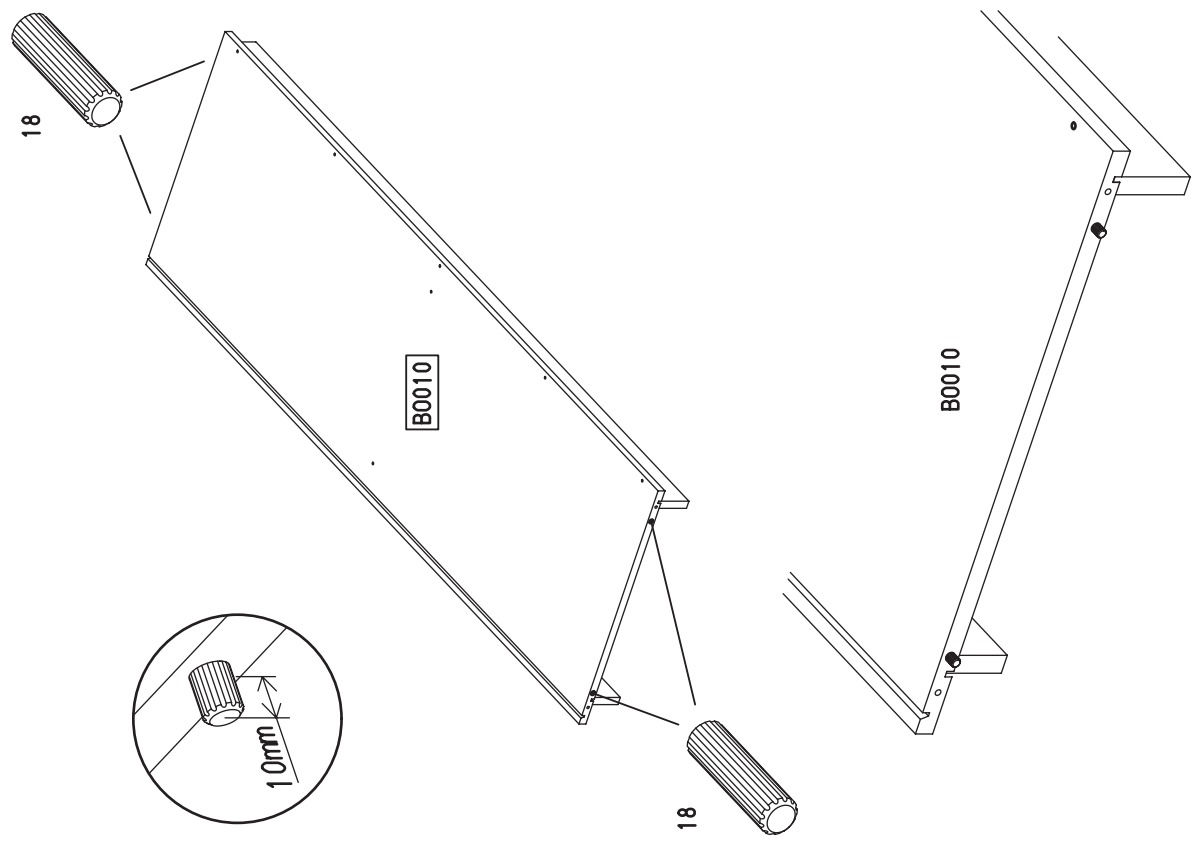

M2514

9.

3	1x (133)	2x (233)	
----------	-----------------	-----------------	--

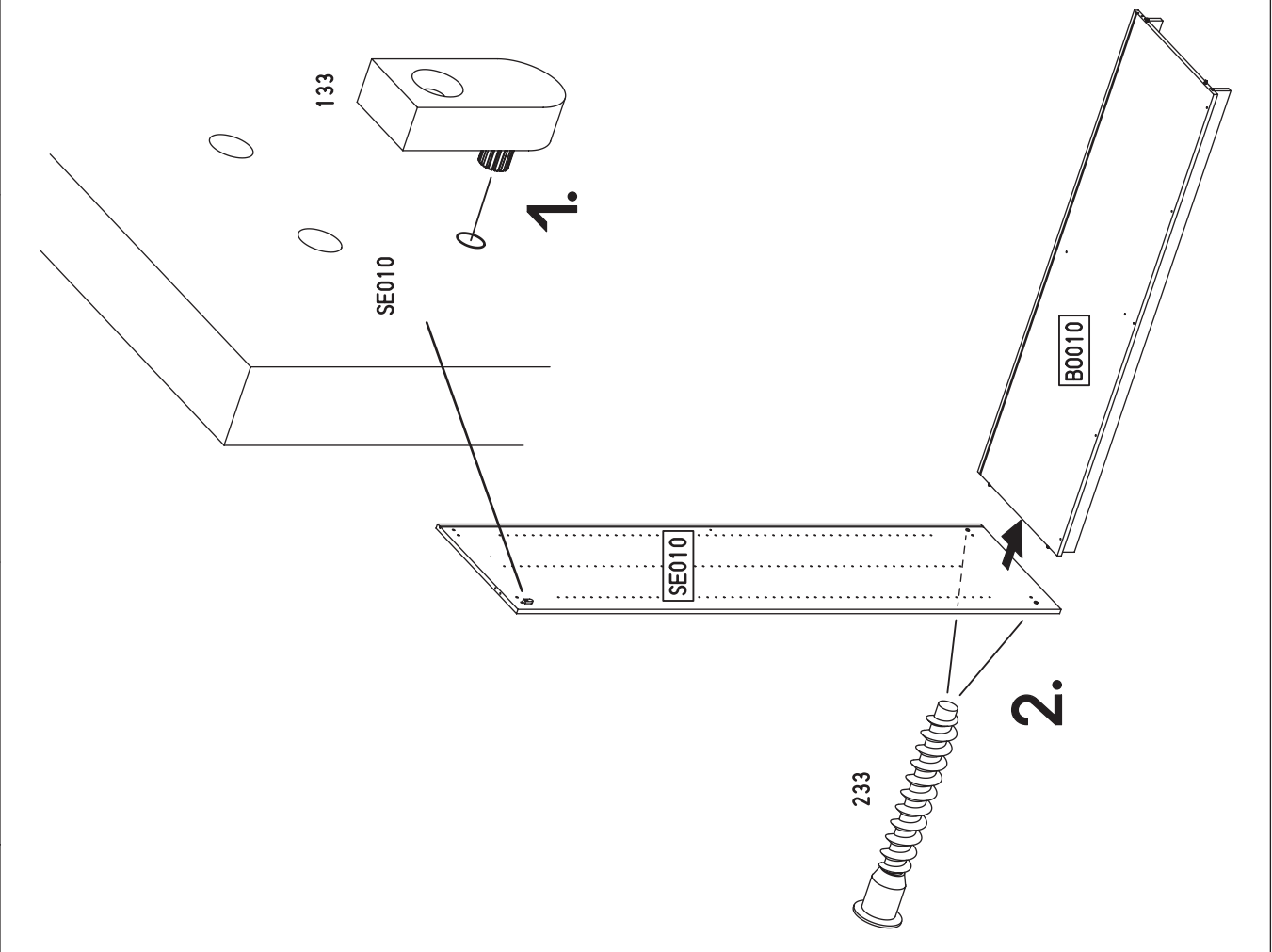

M2514

10.

4	1x (1)	1x (779)	
----------	---------------	-----------------	---

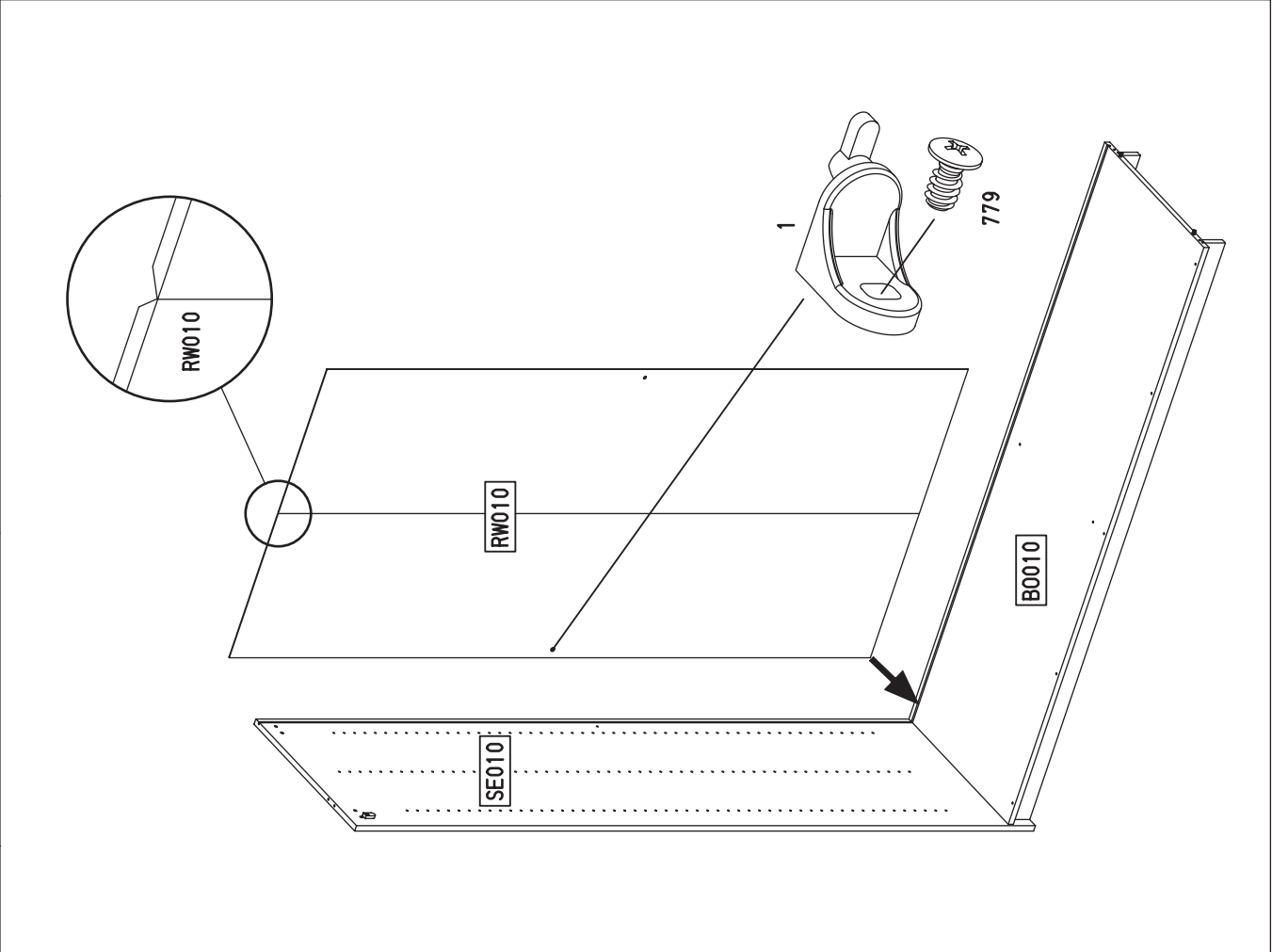

M2514

11.

5

2X (807)

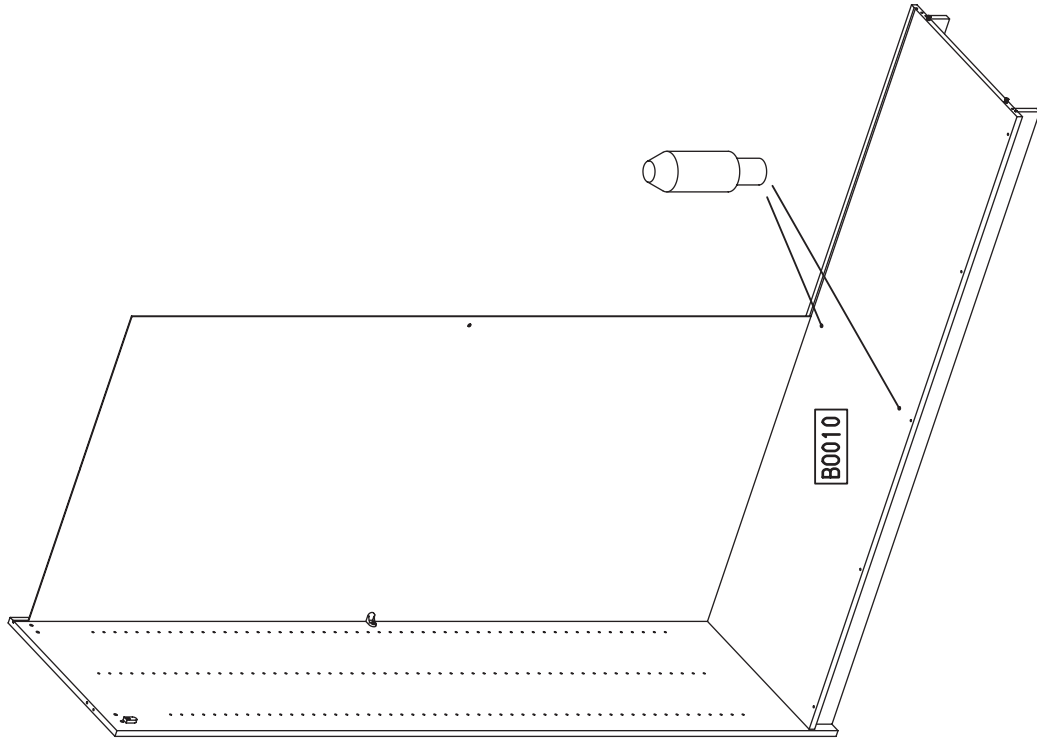

M2514

12.

6

1X (1)



1X (779)



6, 3x12

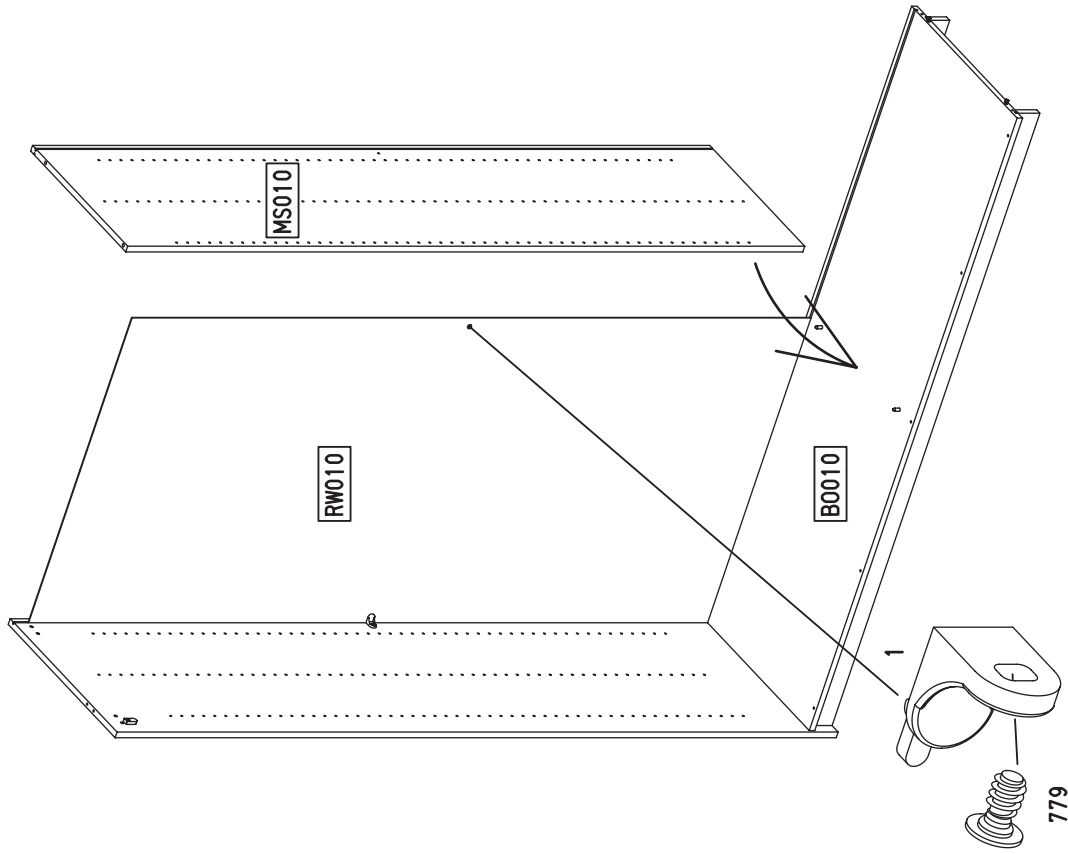

M2514

13.

7

1x ①



1x ⑦⑨



6, 3x12

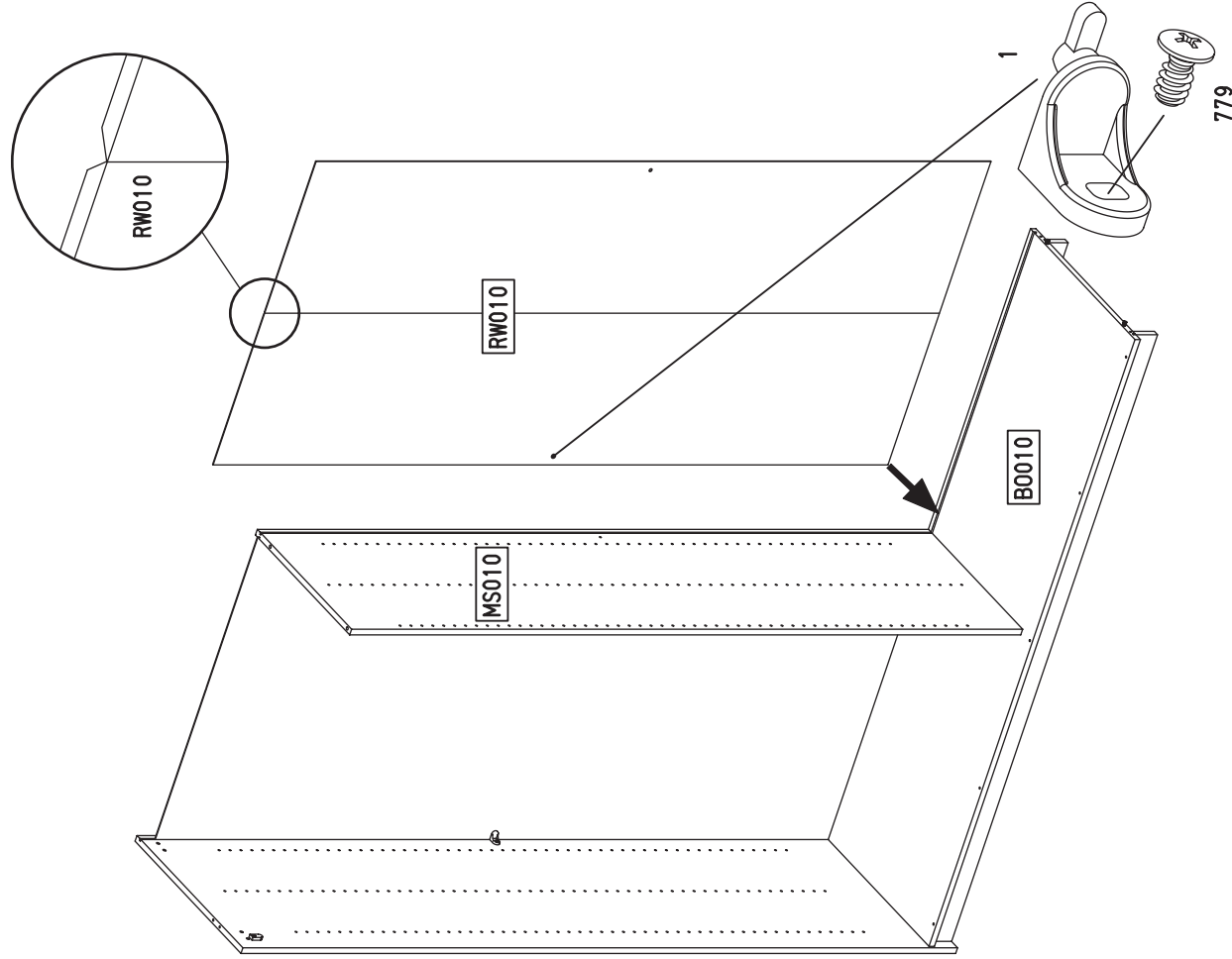
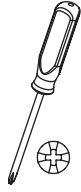

M2514

14.

8

4x ⑱

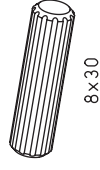

8x30

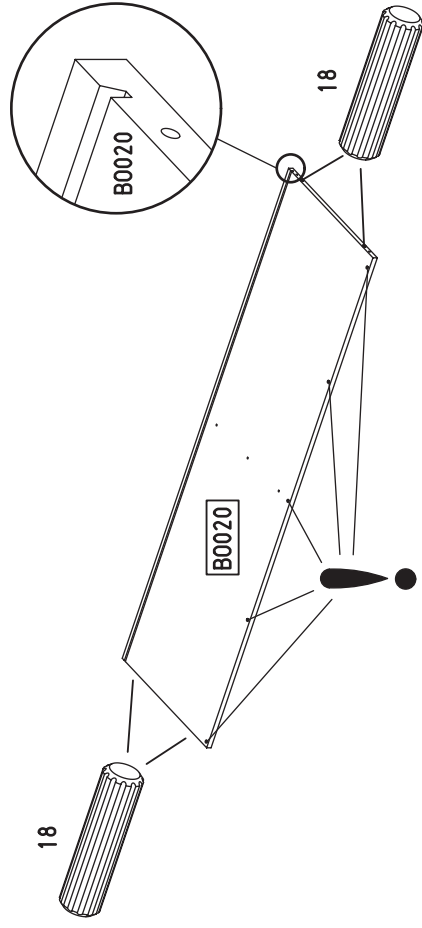

9

2x ⑥⑦

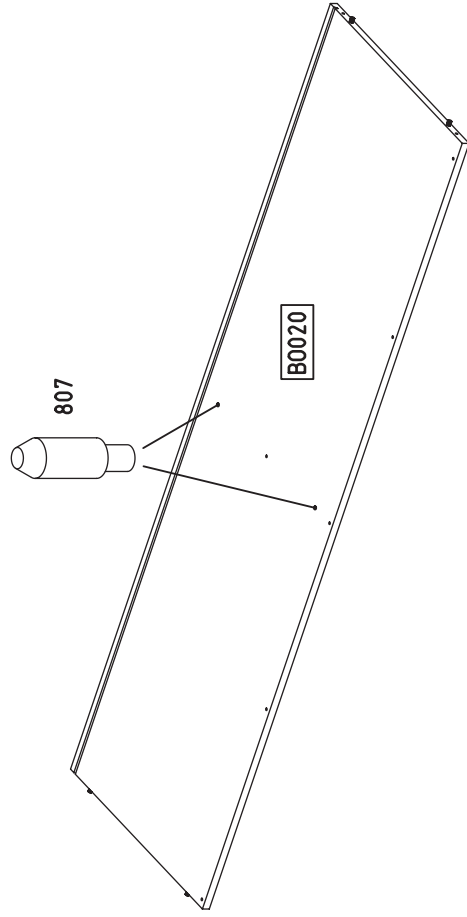

M2514

15.

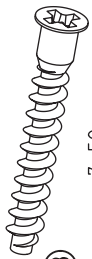

2X (233)

10

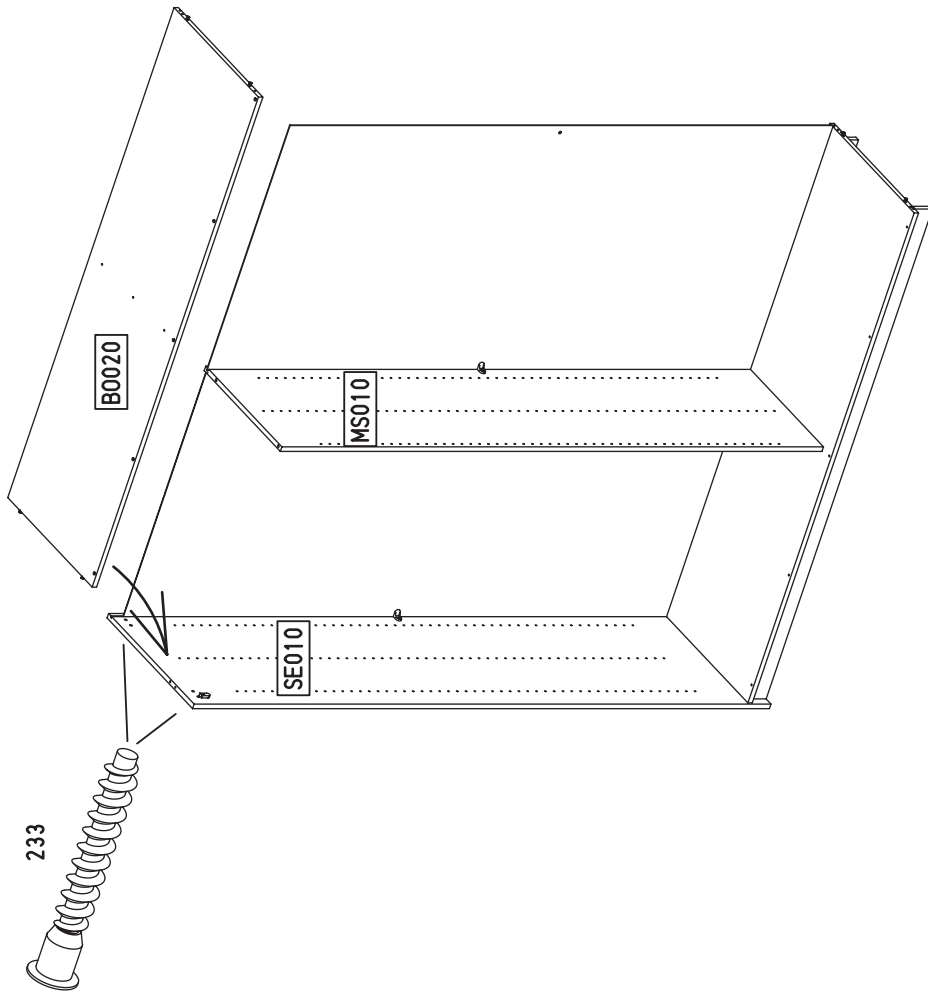
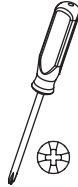

M2514

16.



2X (233)

11

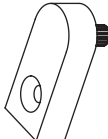

1X (133)

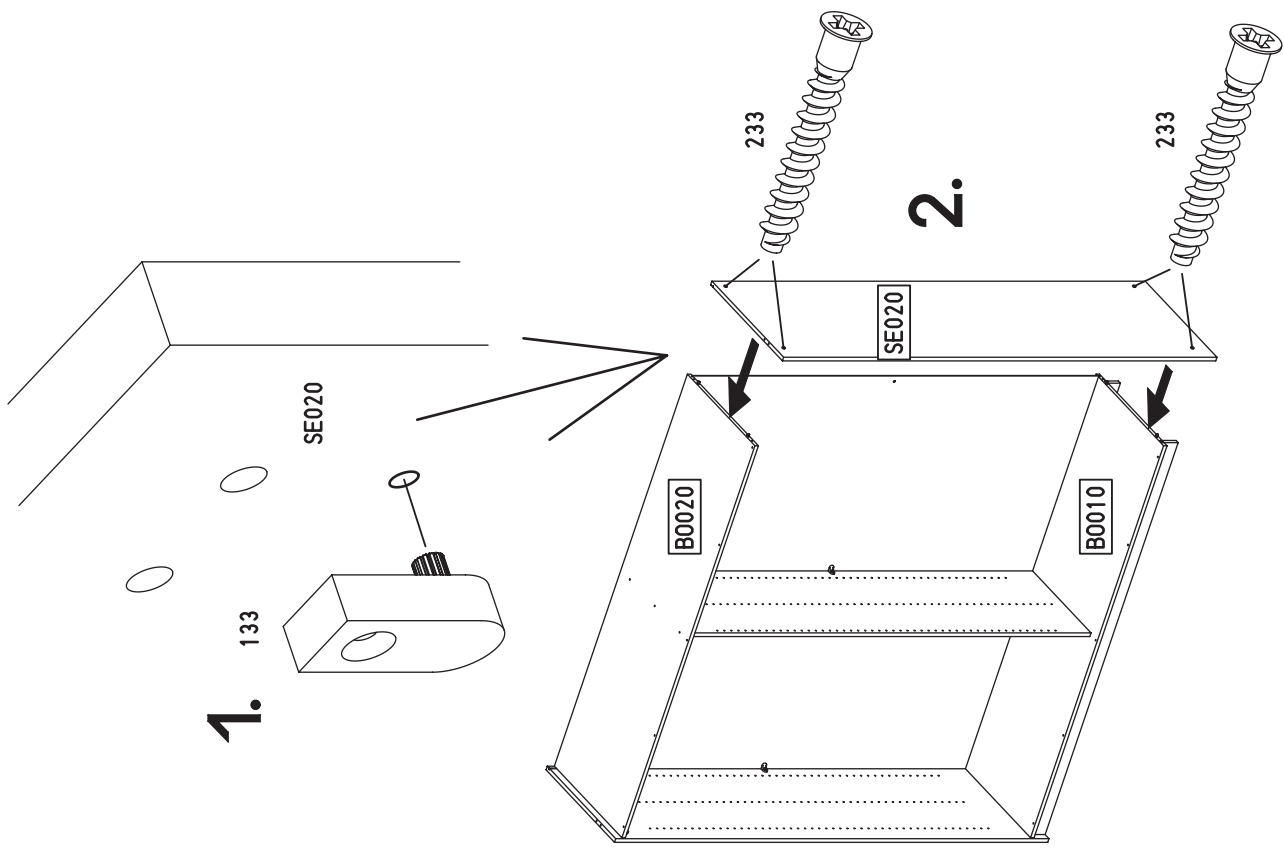
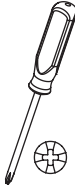

M2514

17.

12

1x 1



1x 779



6, 3x12

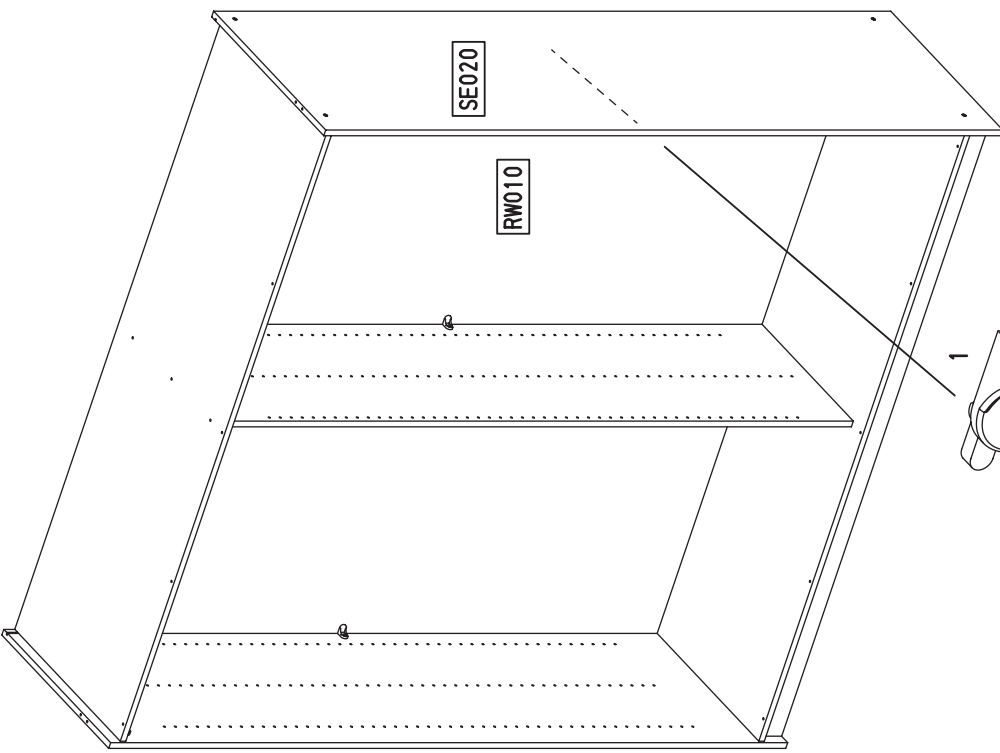
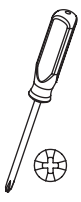

779

M2514

18.

13

1x 296



4, 5x50

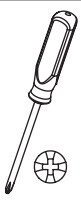

296

B0020

MS010

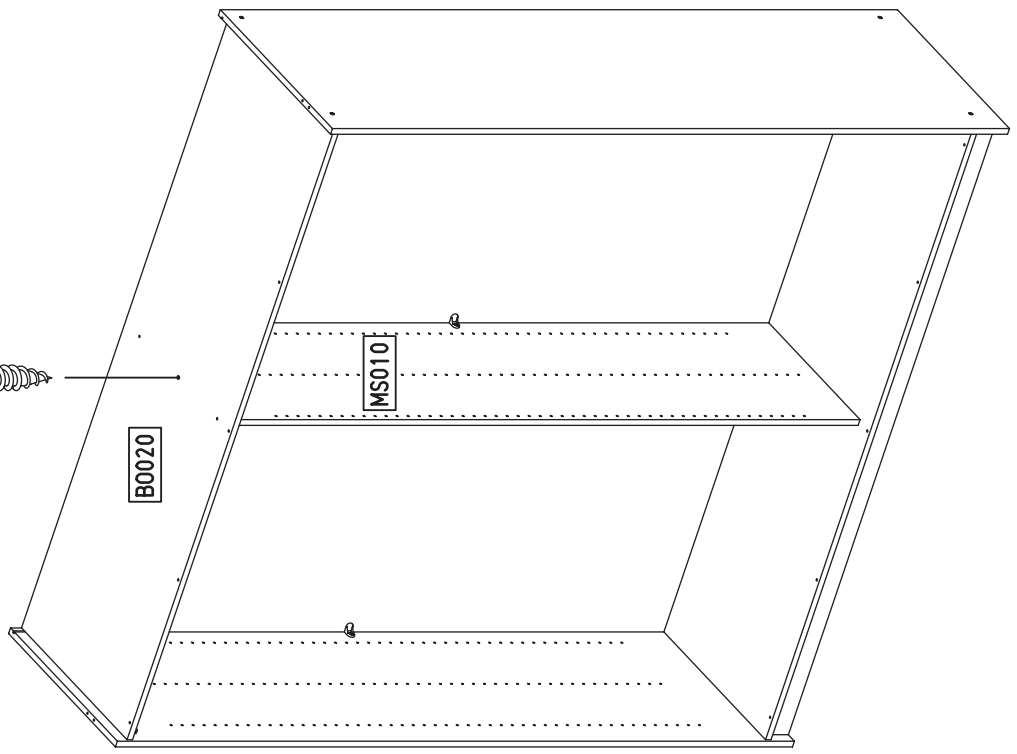

M2514

19.

14

2X 202



4,5x16

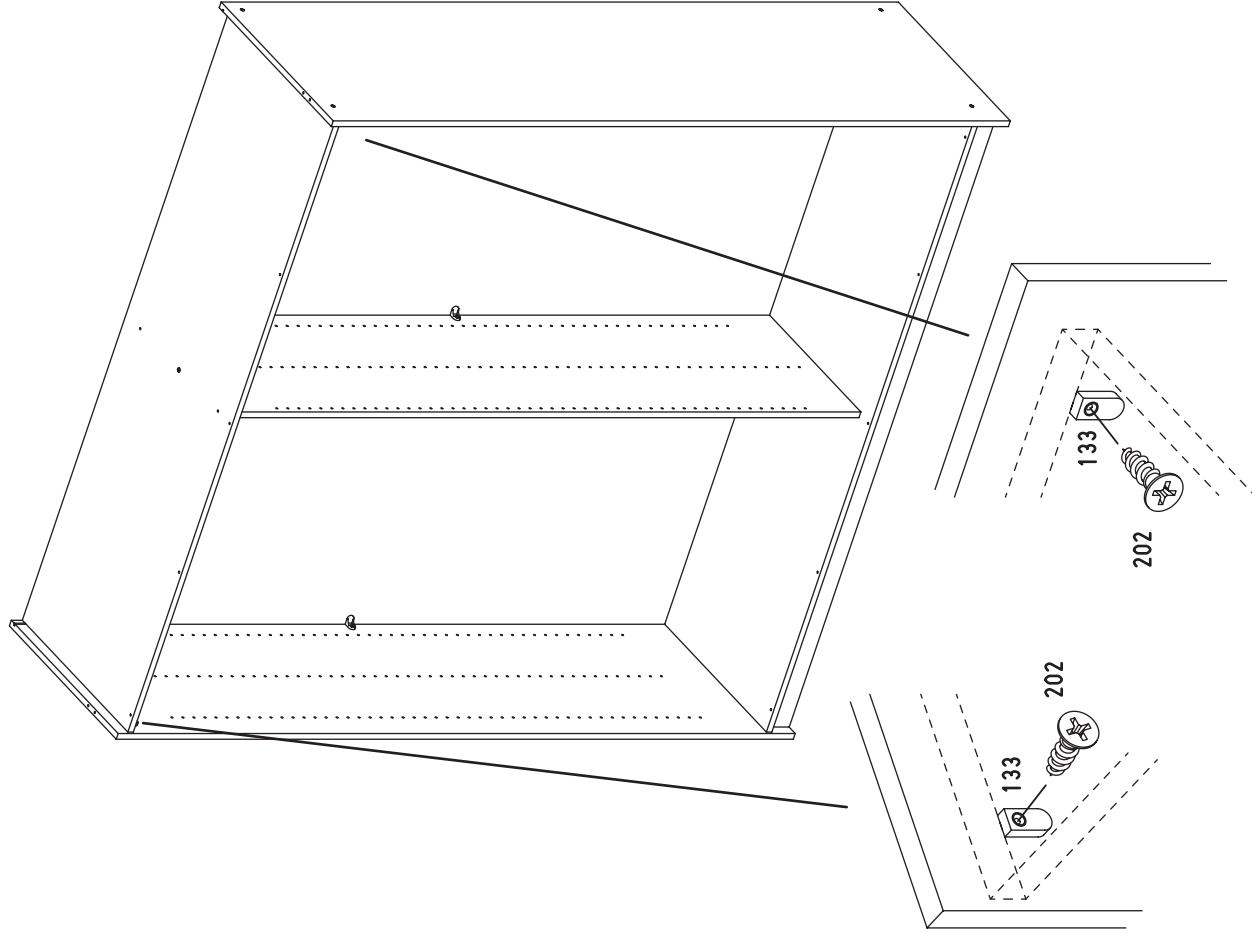
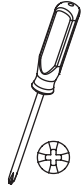

M2514

20.

15

3X 227



6x10,5

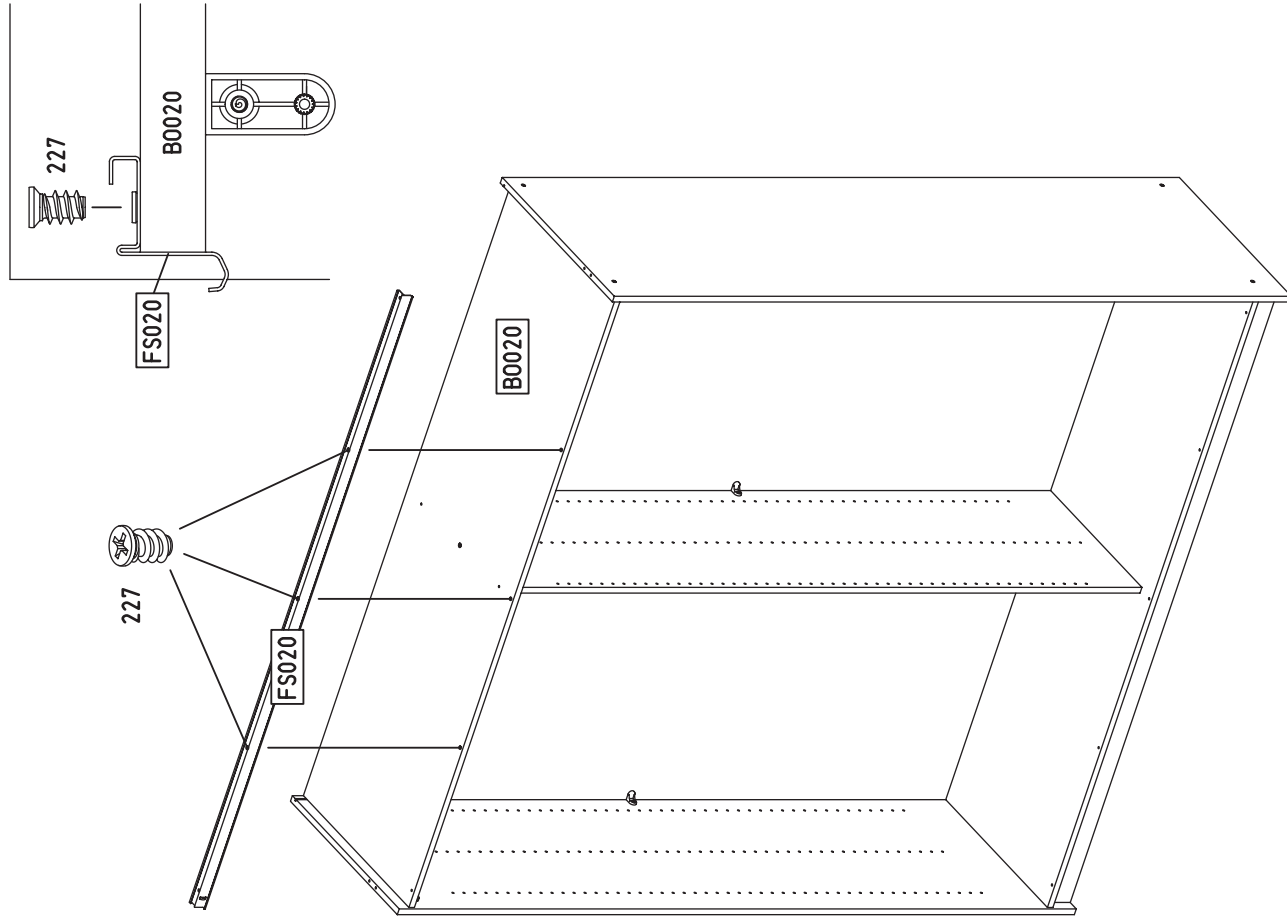
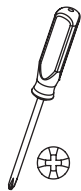

M2514

21.

1x (957) 1x (444) 1x (580) 5/M4x15

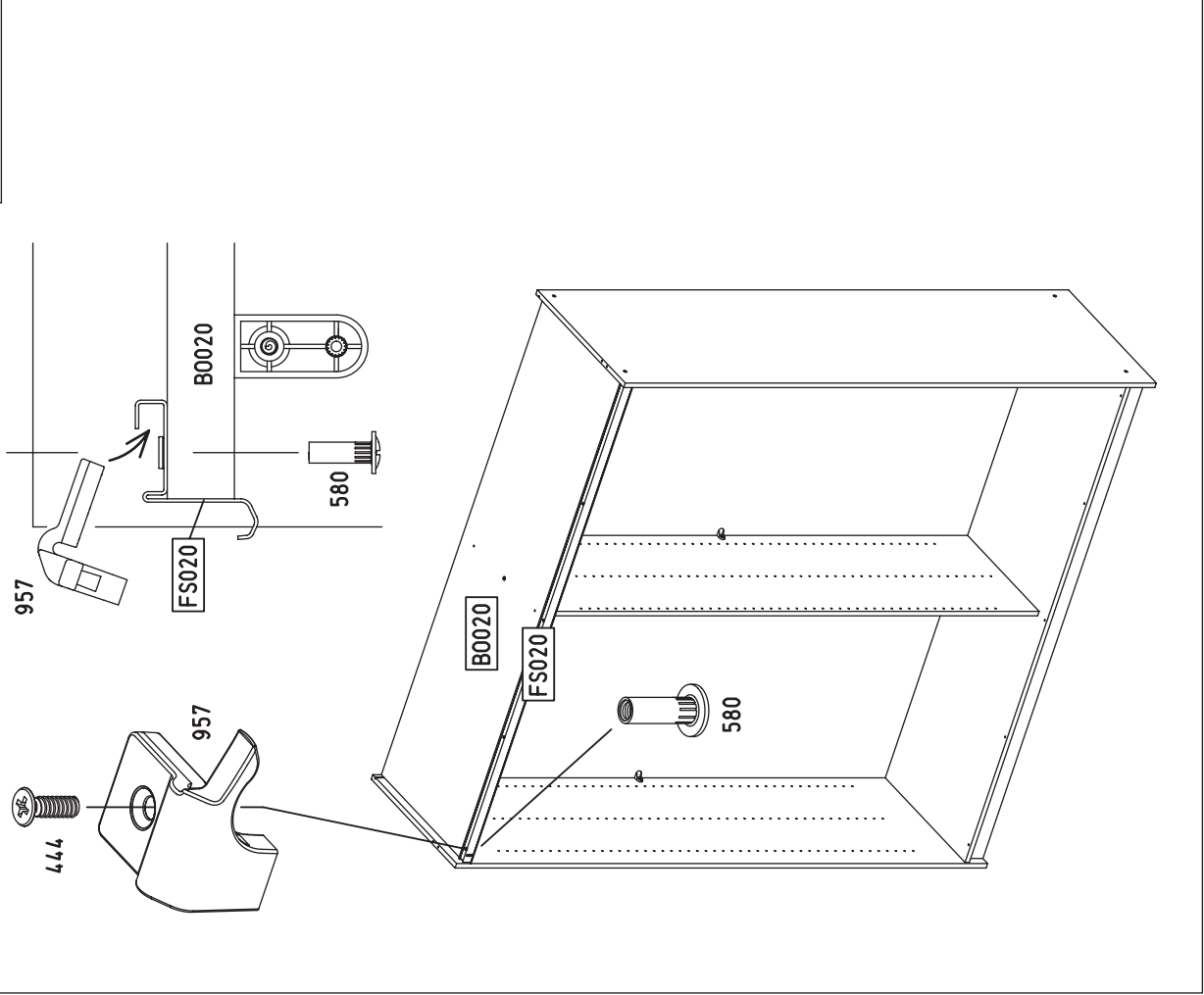
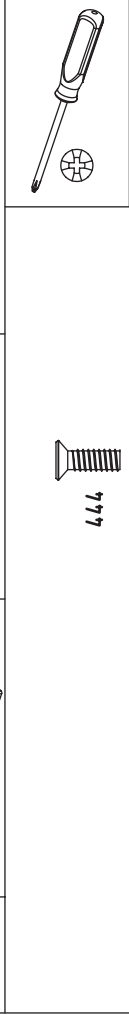

M2514

22.

17 1x (958) 1x (444) 1x (580) 5/M4x15

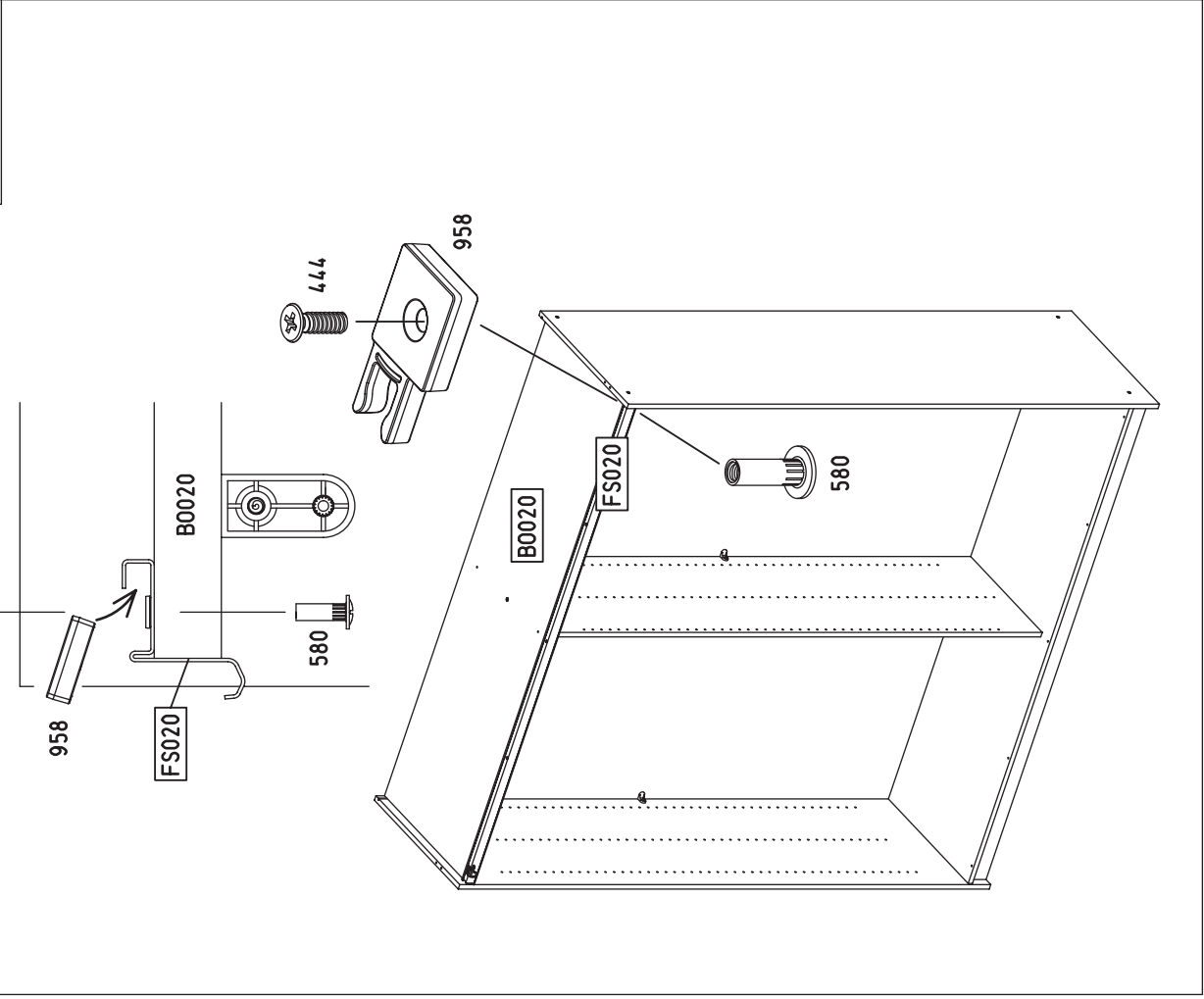
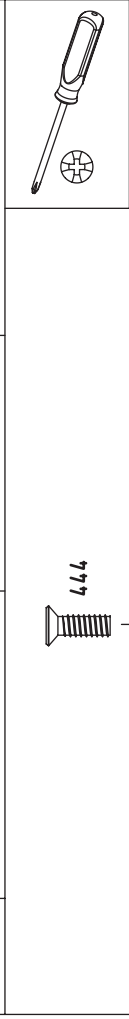

M2514

23.

18

5x (203)

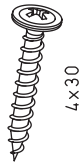

4x30

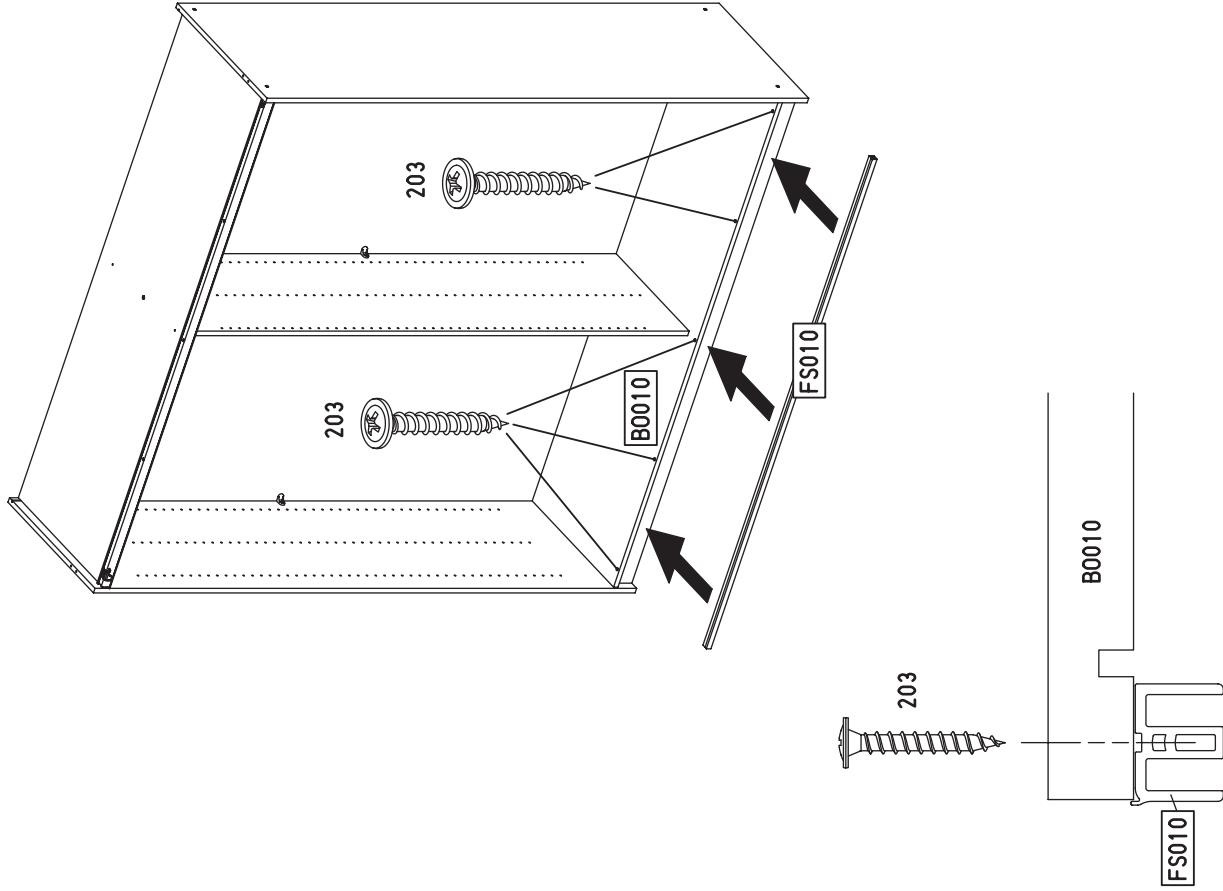
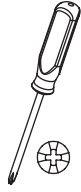

M2514

24.

19

3x (88)



3,5x12

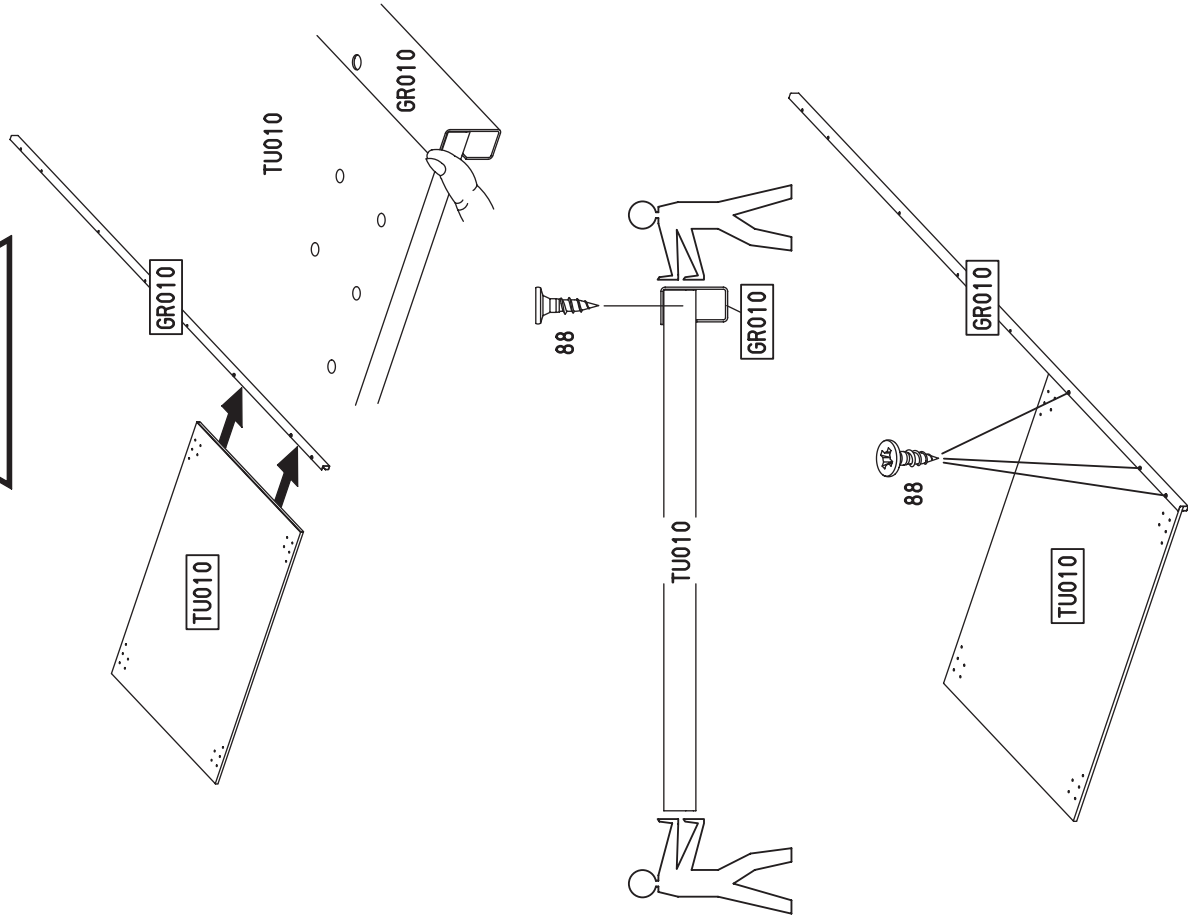
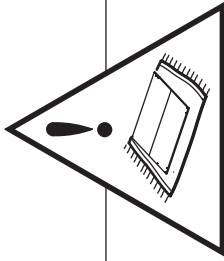
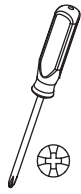

M2514

25.

20

1x 160

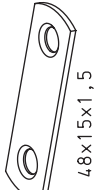

48x15x1,5

1x 88



3,5x12

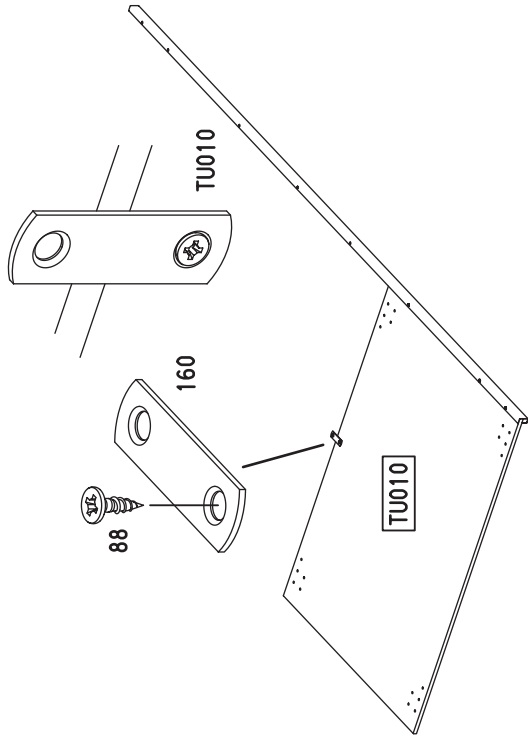

21

3x 88



3,5x12

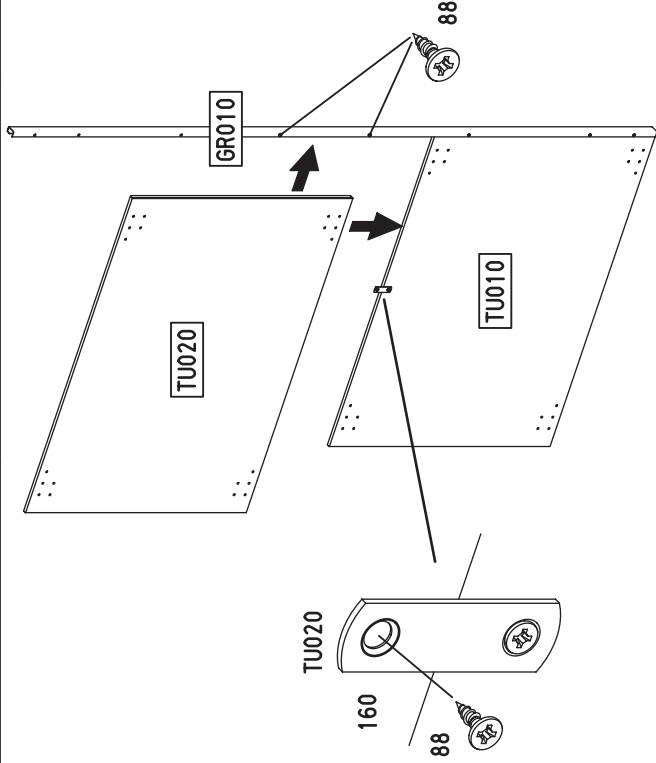
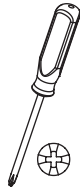

26.

22

1x 160

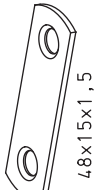

48x15x1,5

1x 88



3,5x12

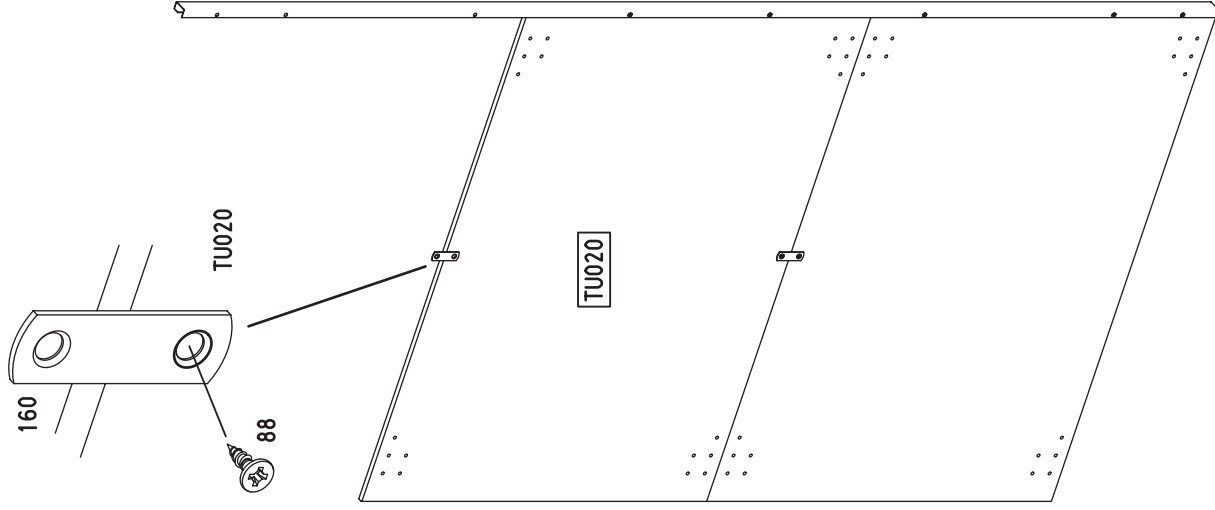
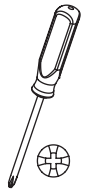

27.

23

4X 88

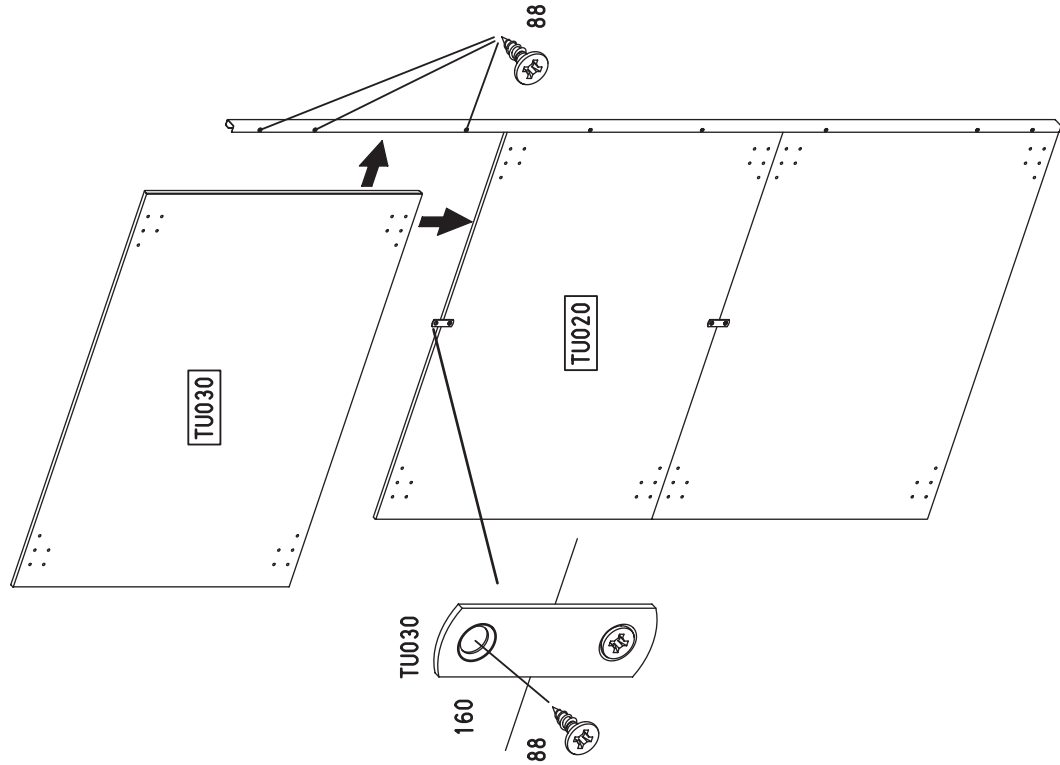
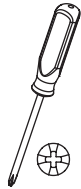

M2514

28.

24

8X 88

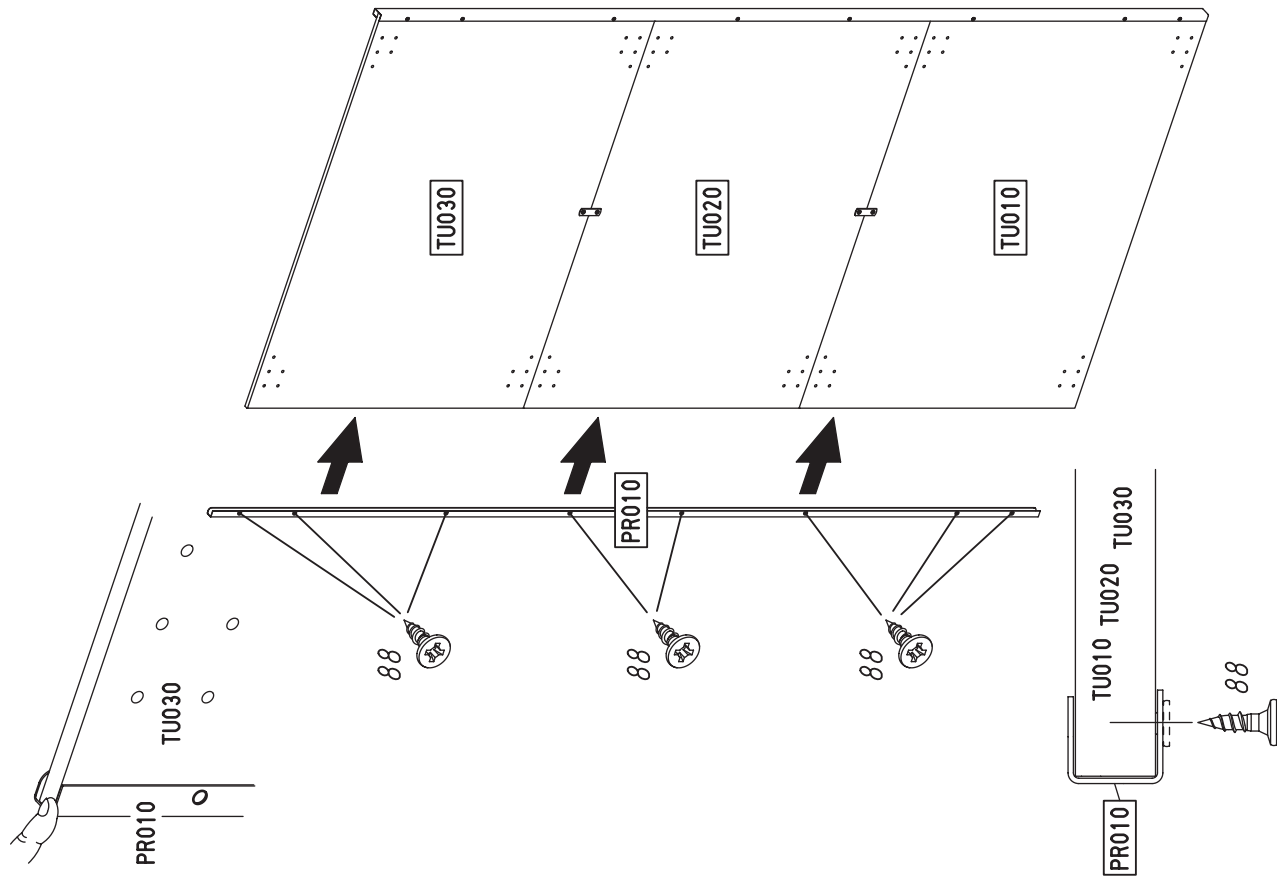
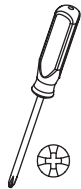

M2514

29.

25

2X 953

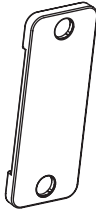

4X 227

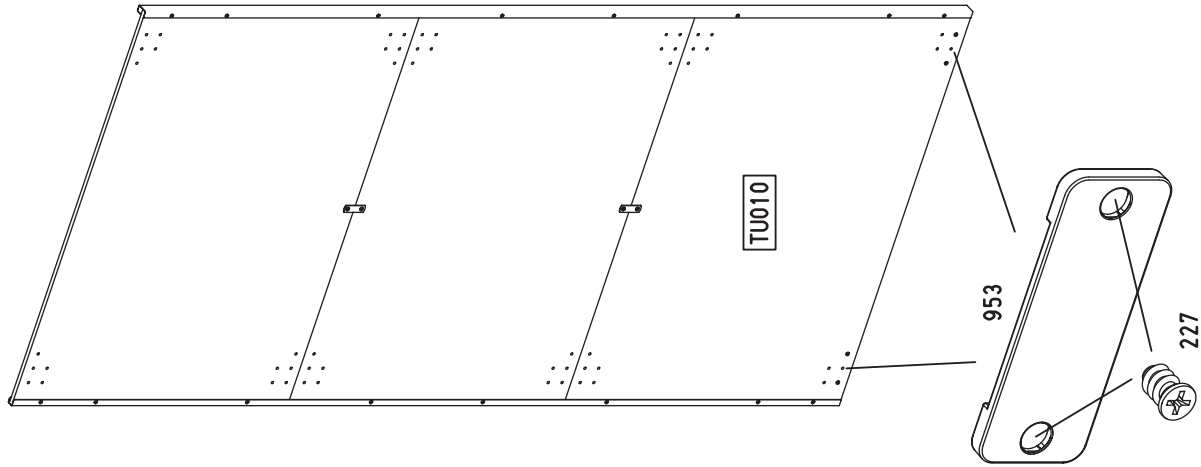
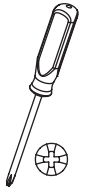

M2514

30.

26

2X 951



8X 227

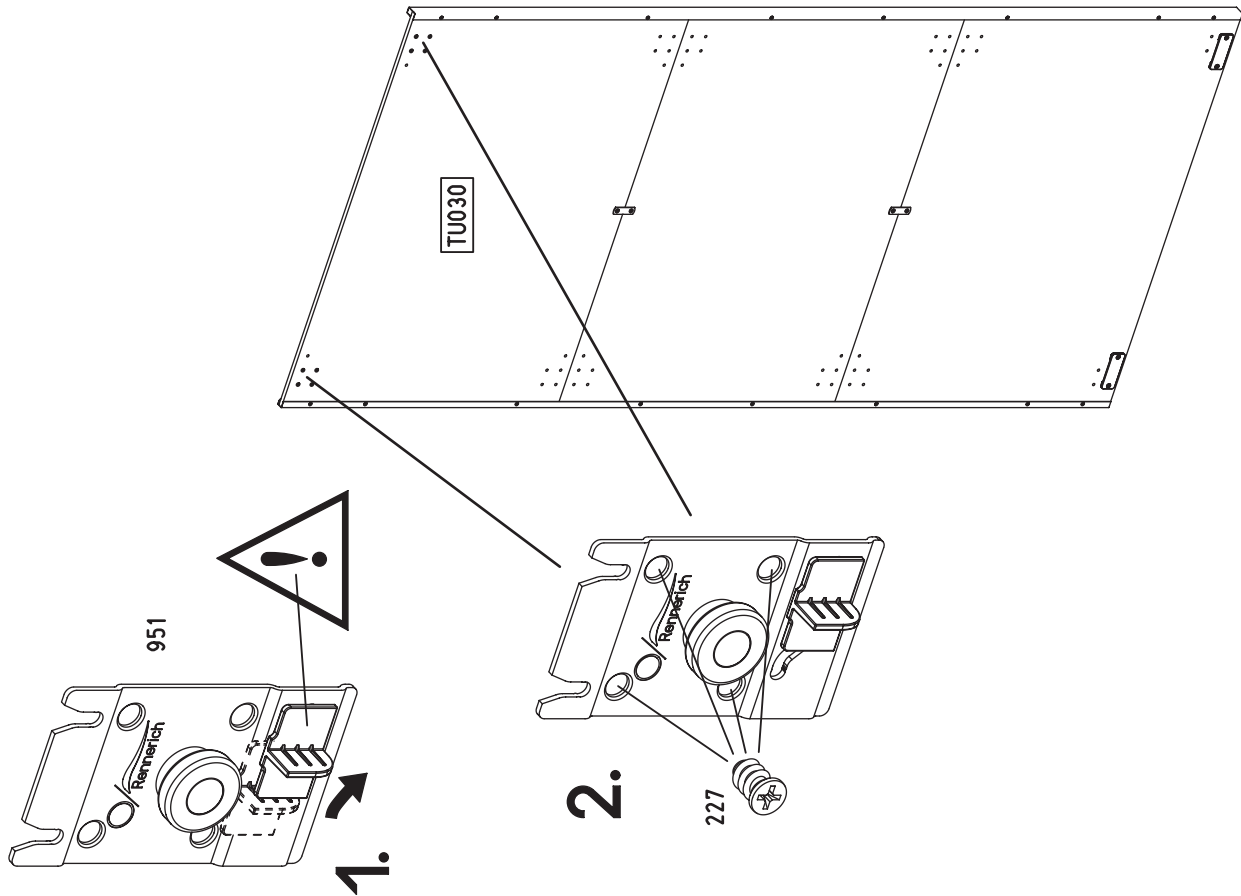
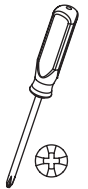

M2514

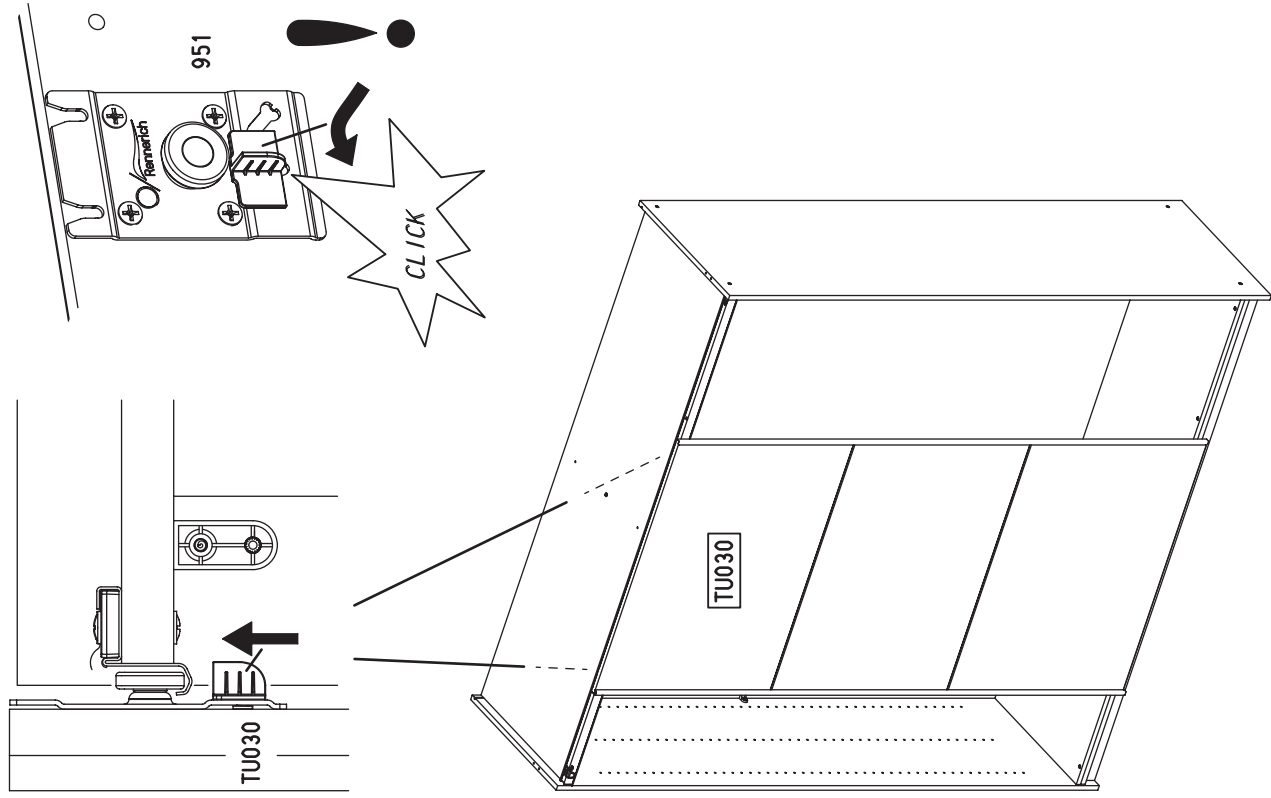
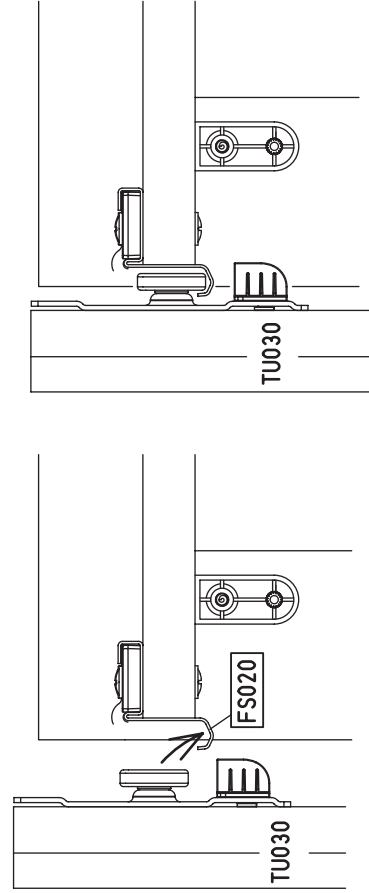
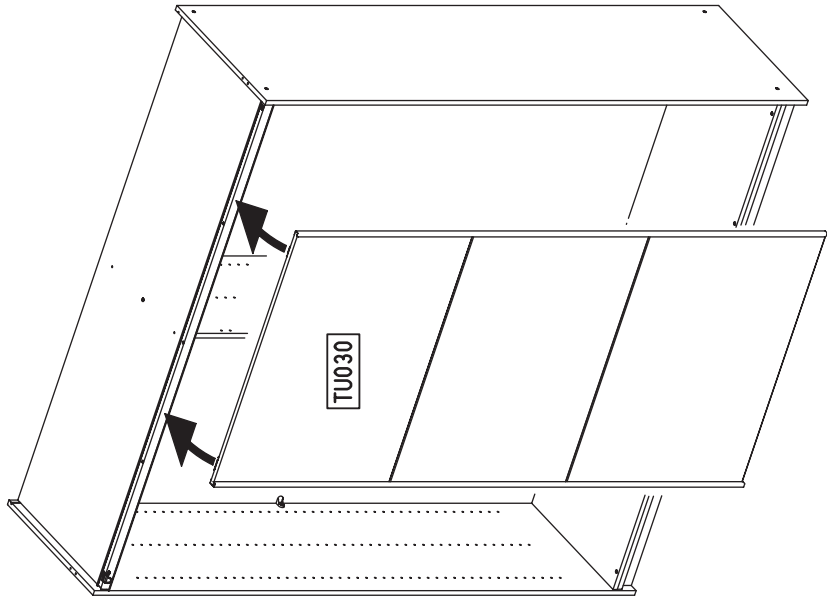

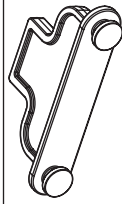

1x 956

29

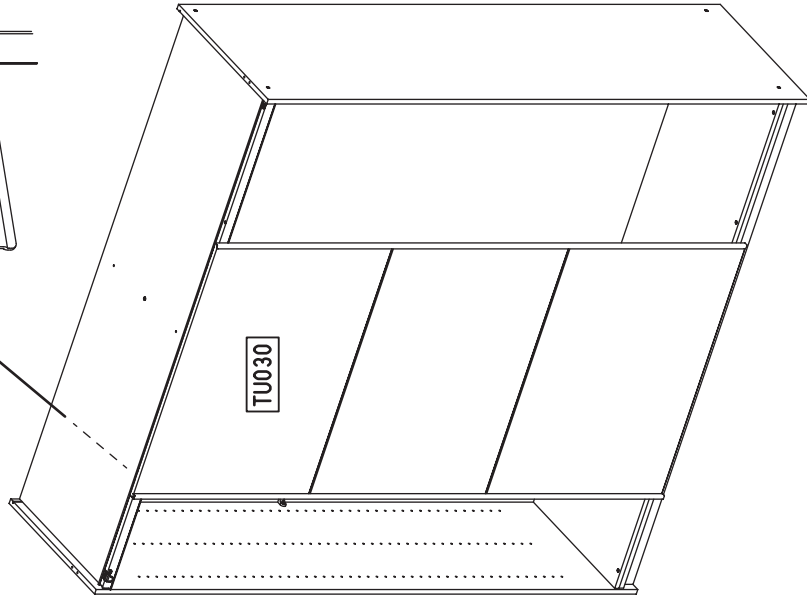
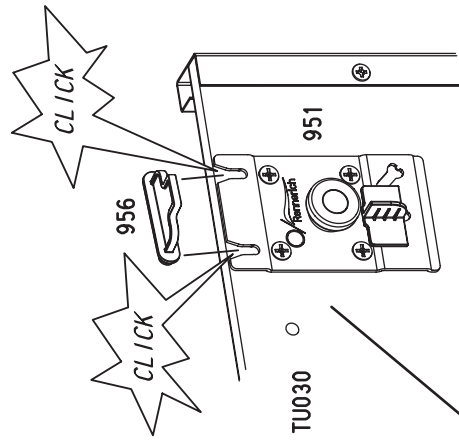

2x 954

30

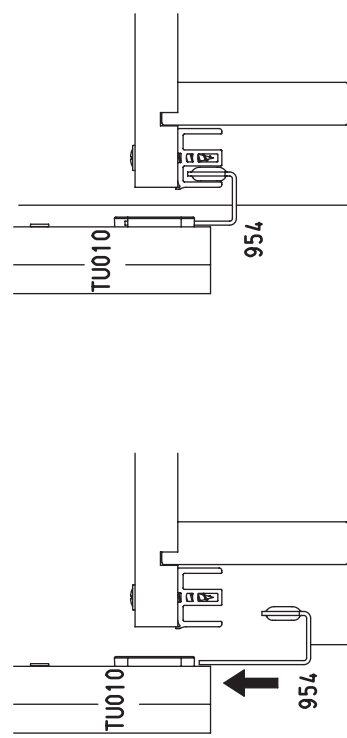
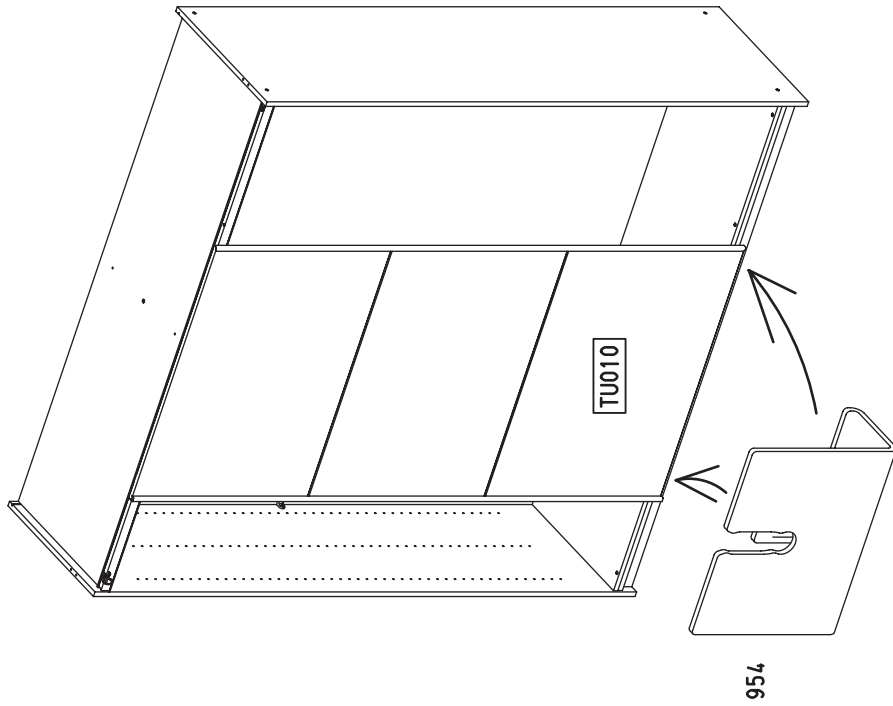

35.

31

3X



3,5x12

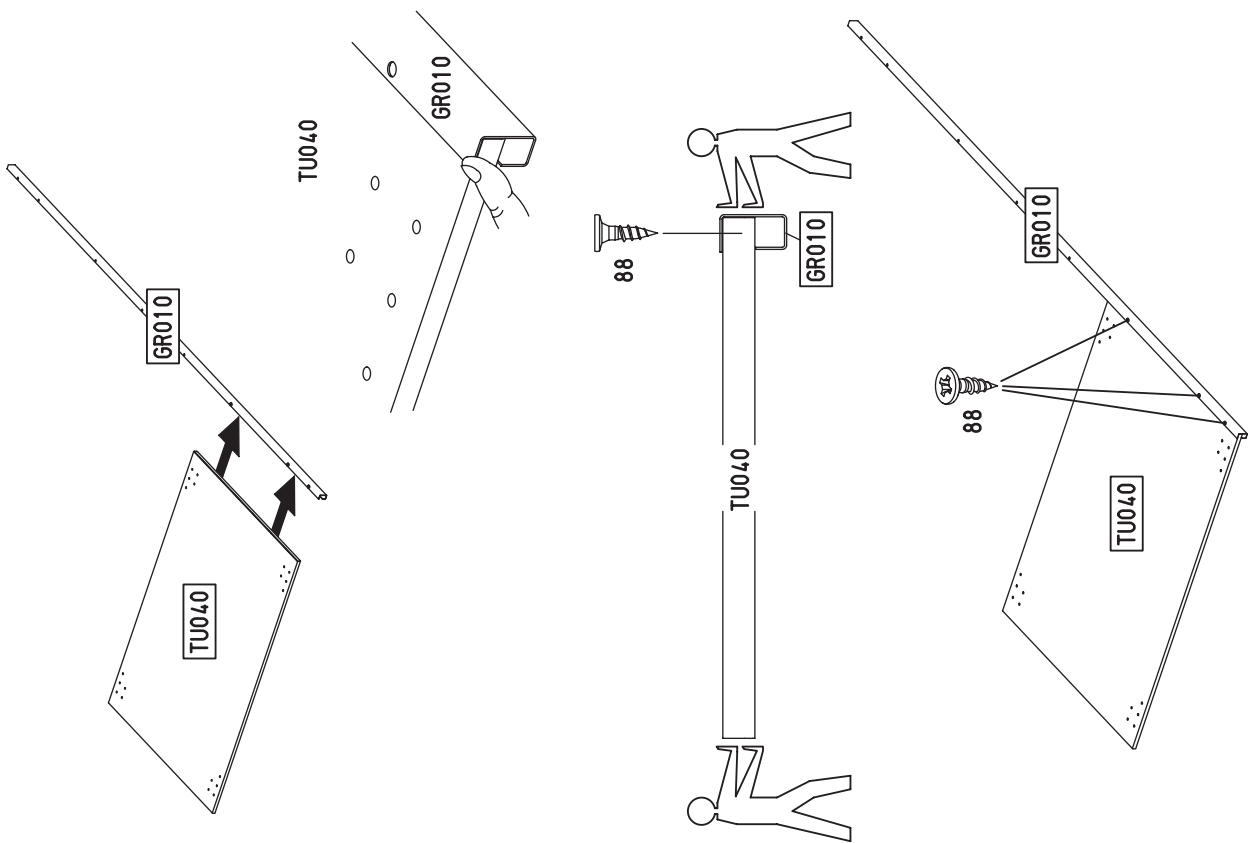
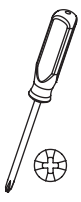

M2514

36.

32

2X

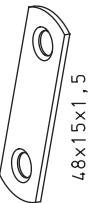

160

9X



3,5x12

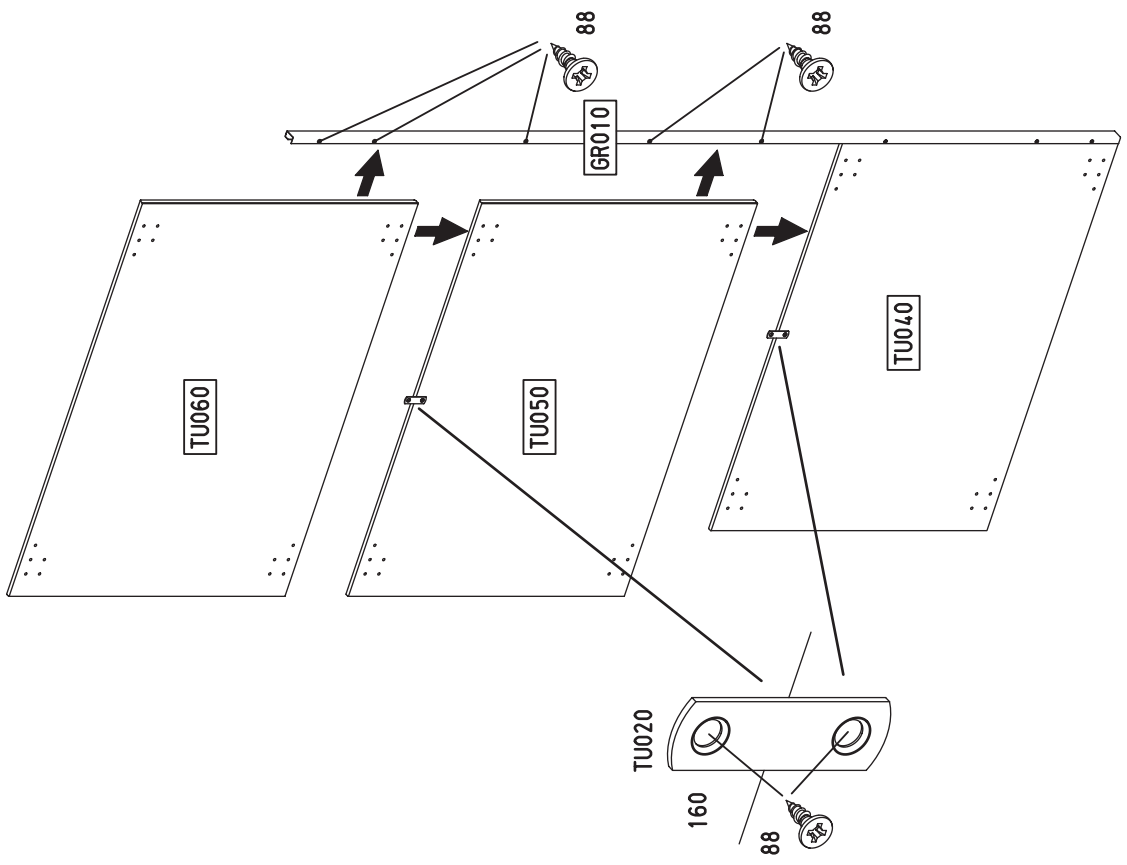
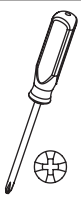

M2514

37.

33

8X 88

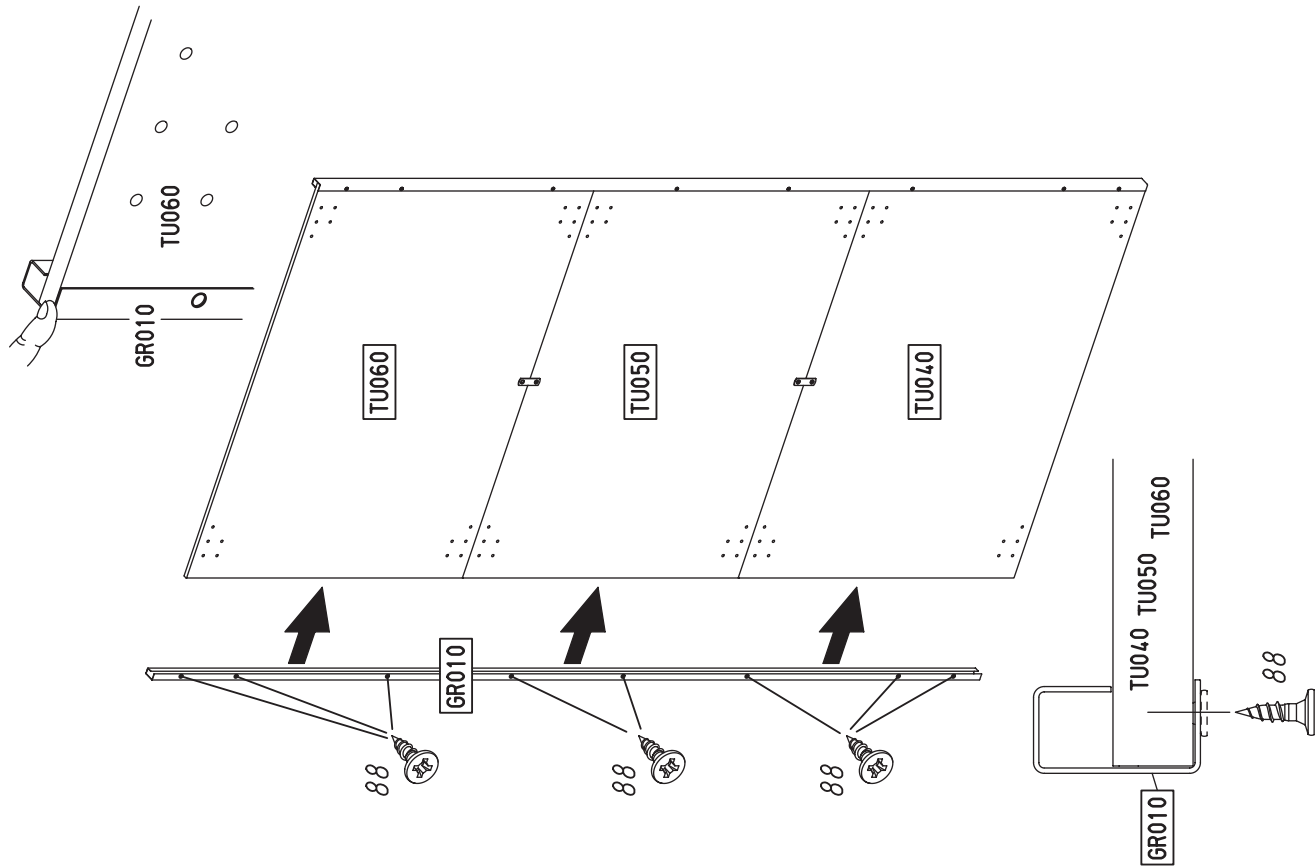

M2514

38.

34

2X 953



4X 227

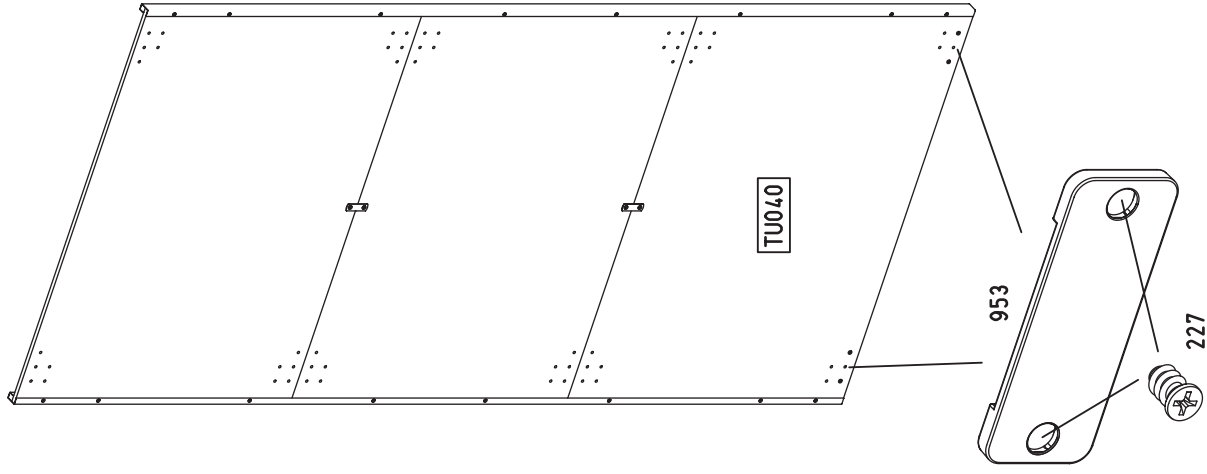
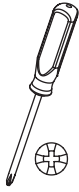

M2514

40.

36

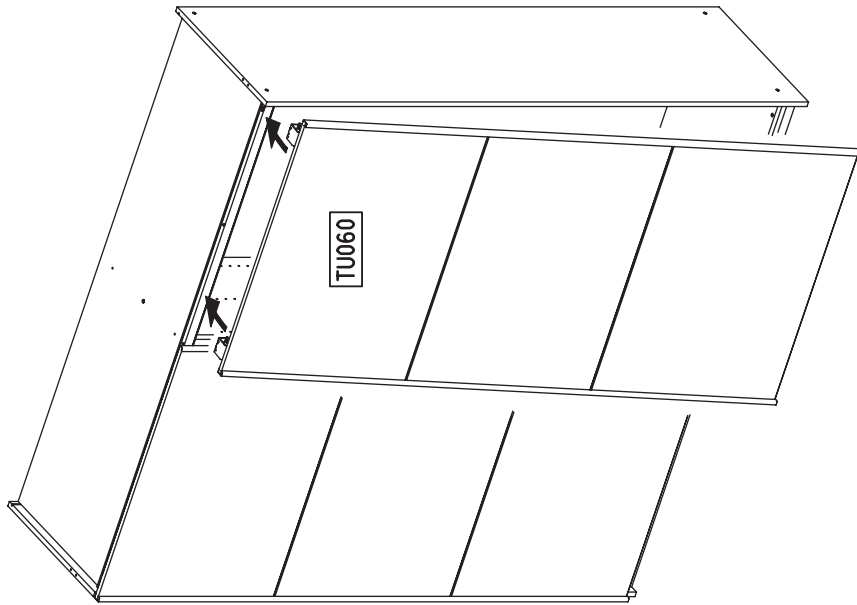
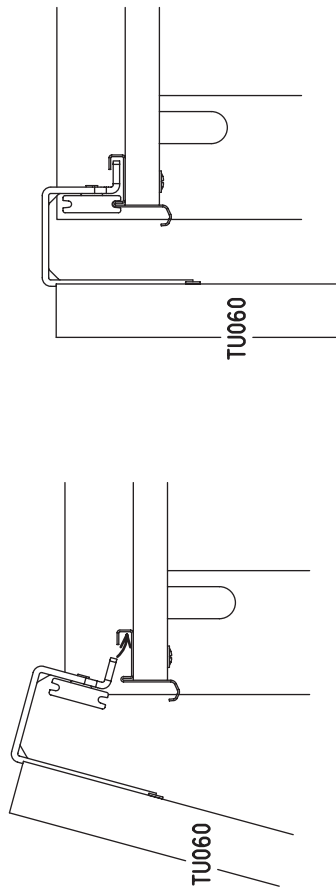

M2514

39.

2X 952



8X 227



6x10,5

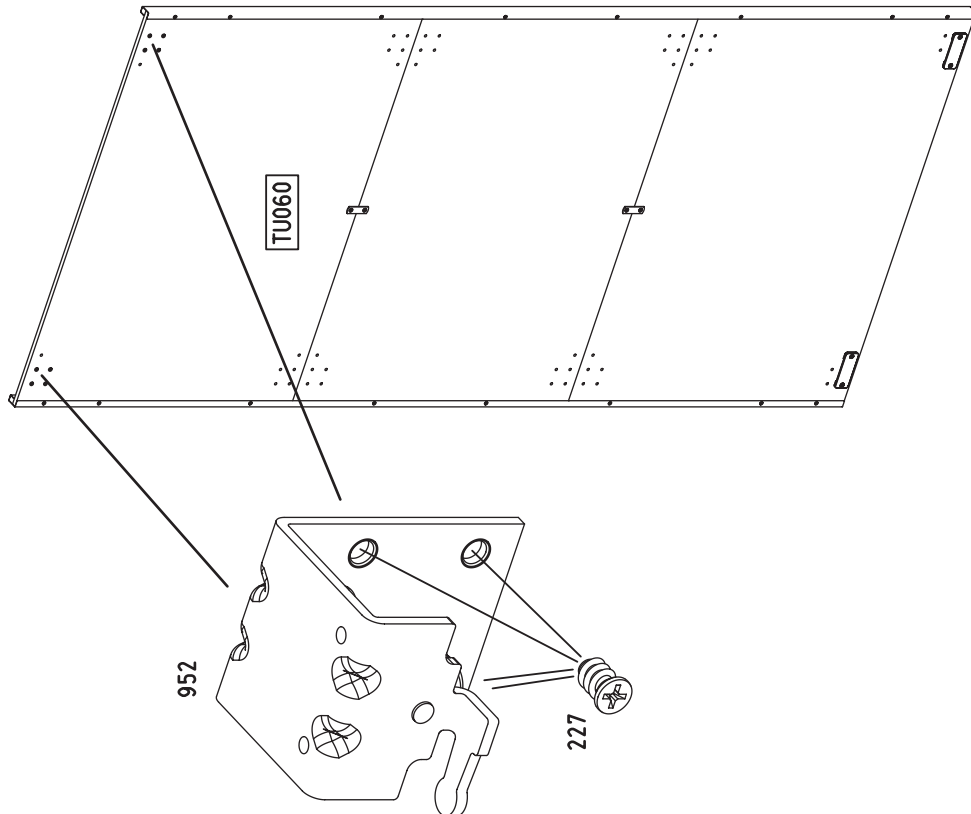
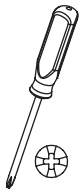

M2514

42.

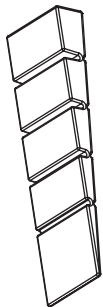

2X 12

38

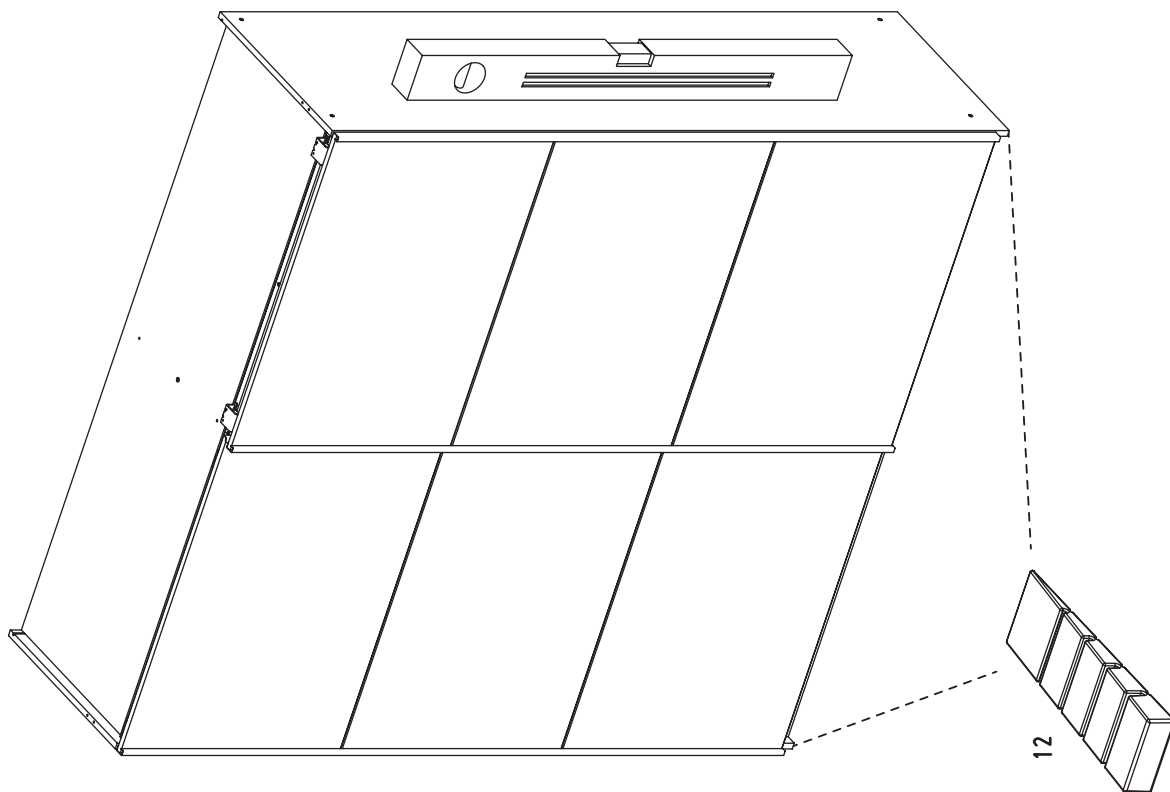

M2514

41.



2X 955

37

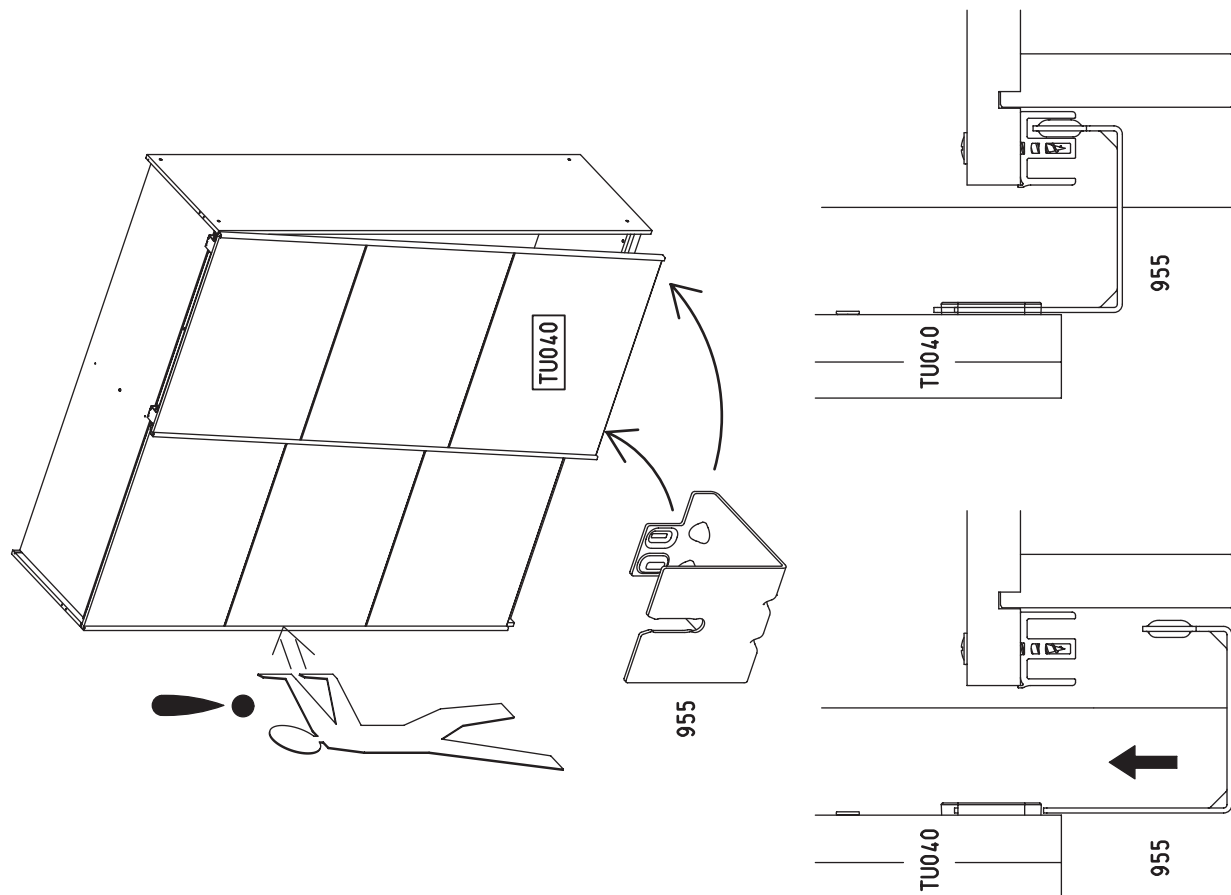

M2514

4.3.

39

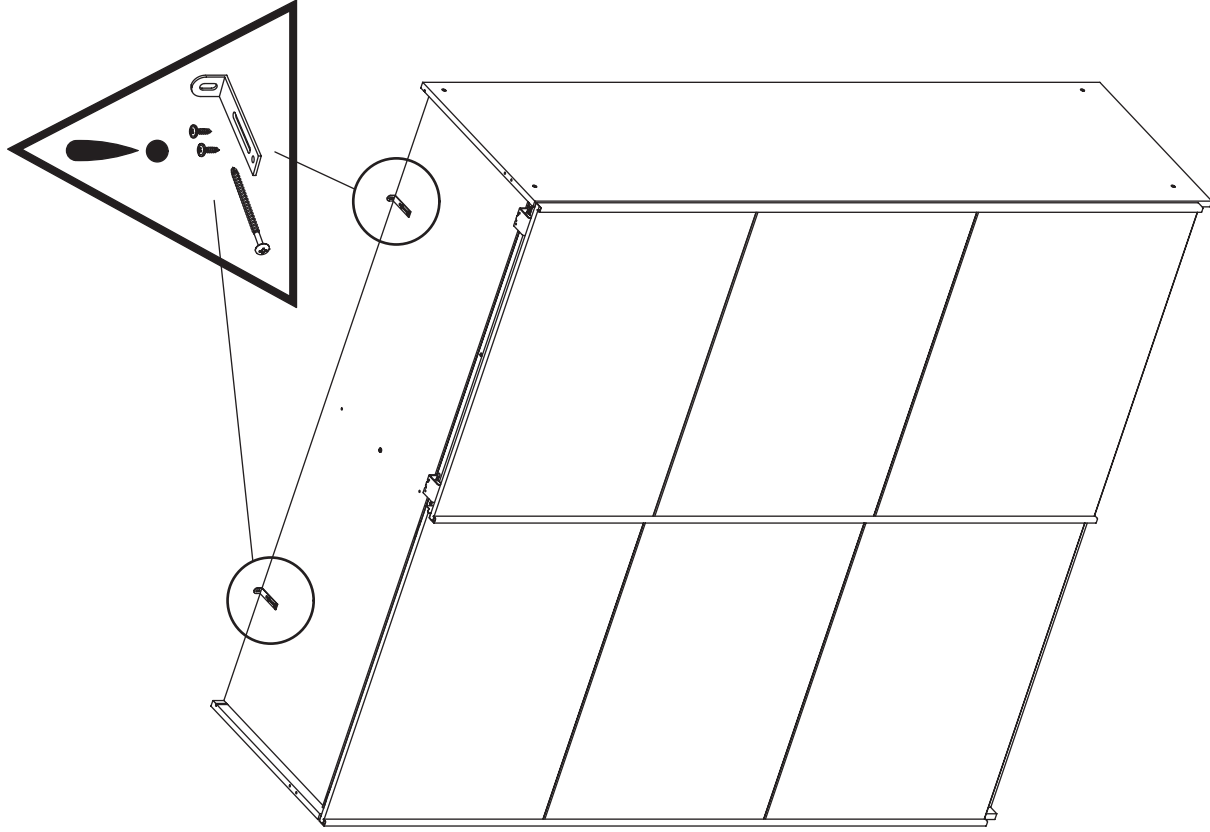

4.4.

40

12x 45

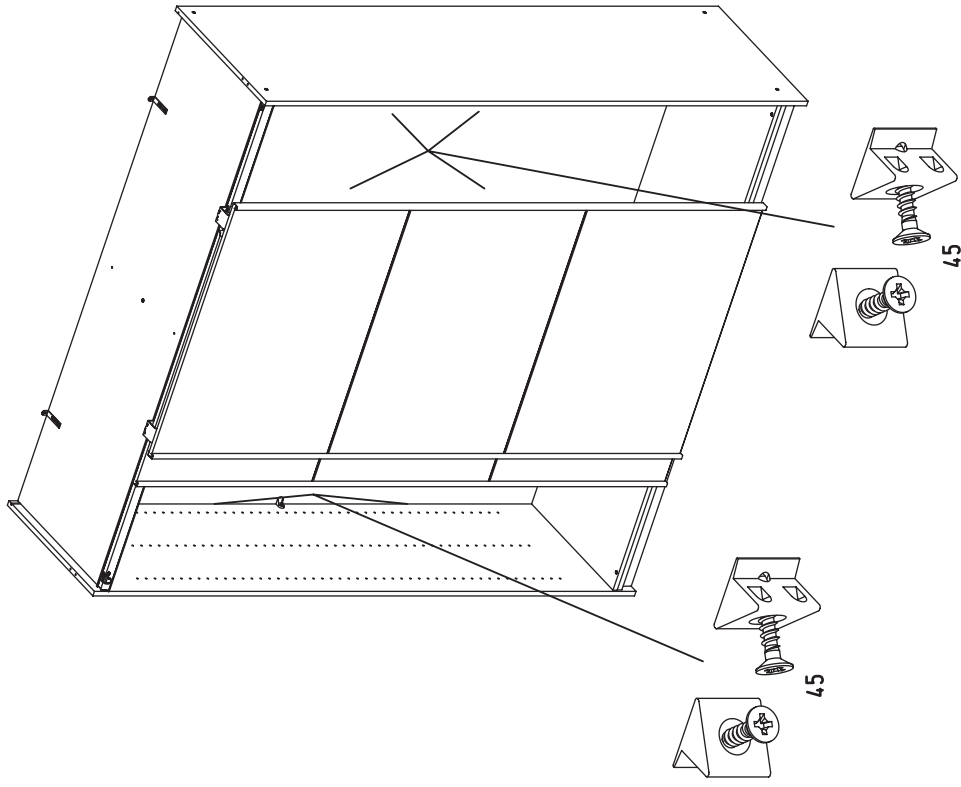
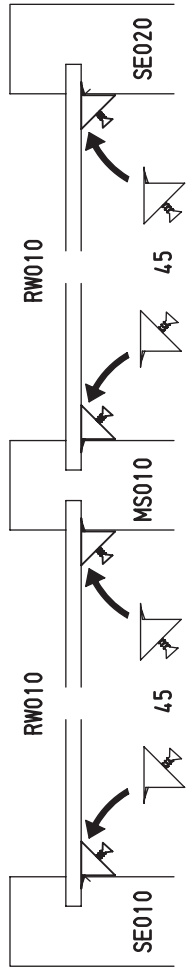
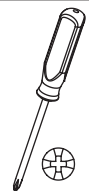
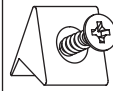

45.

41

8X



271

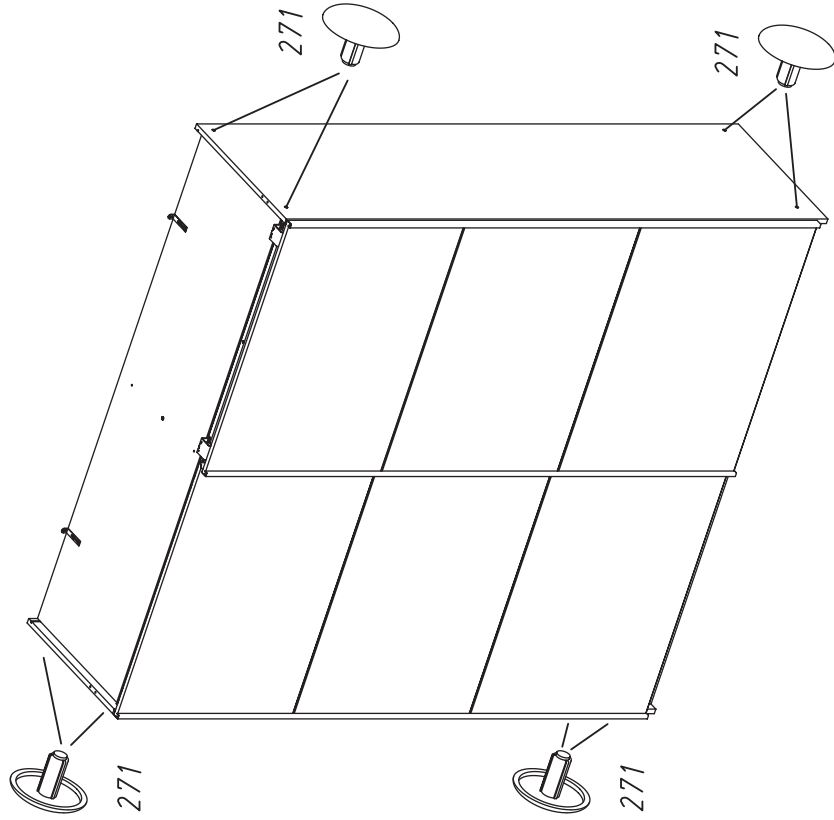

M2514

46.

42

6X



177

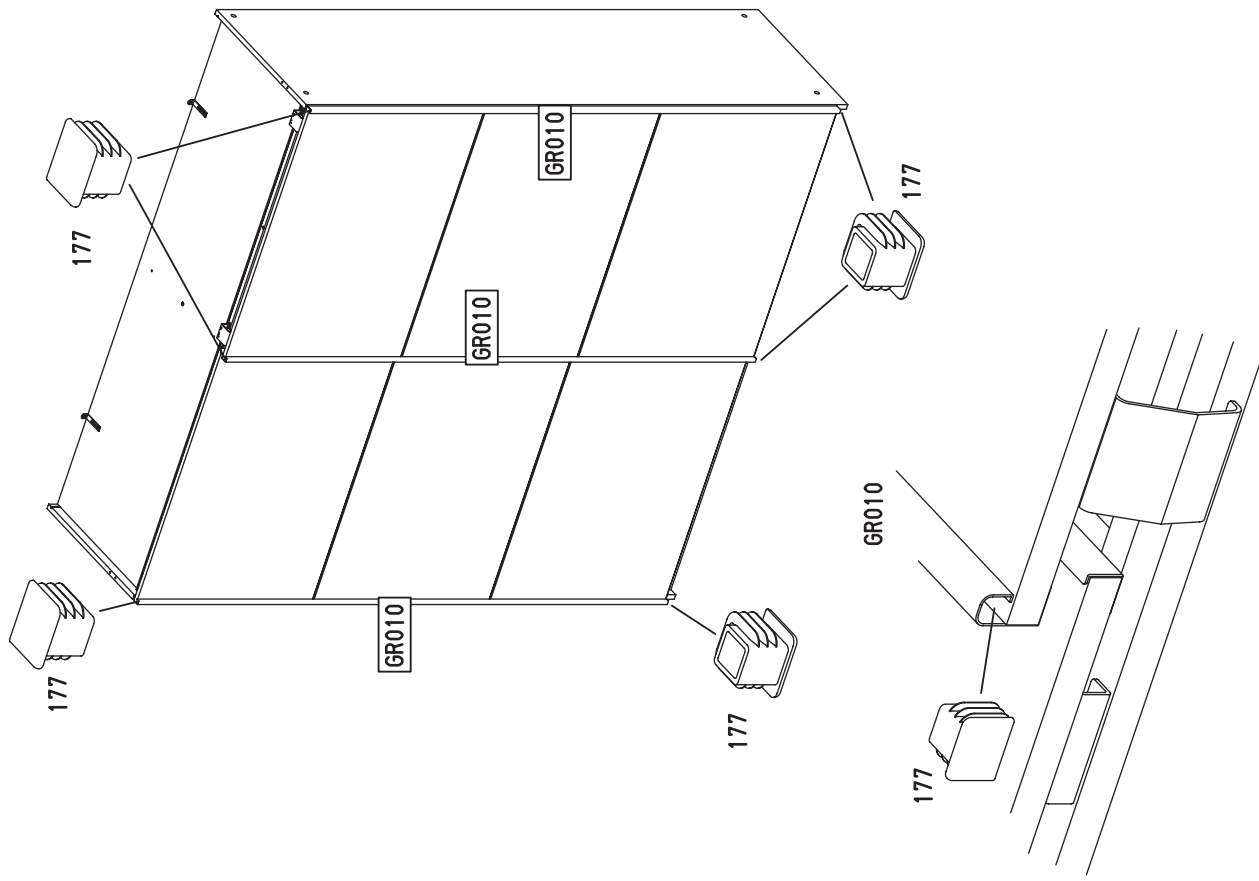



M2514

2x (88)

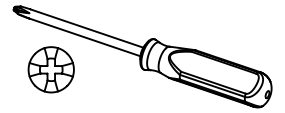

2x (279)

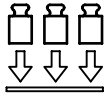

Xmm	 	(XXXX)
841mm	max. 40kg	(2005)
1057mm	max. 40kg	(2007)

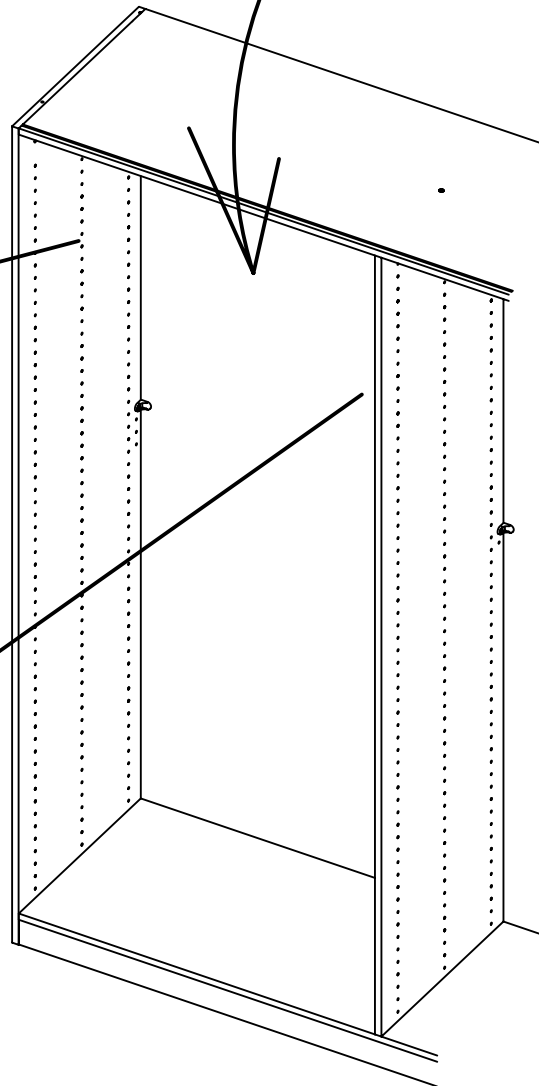
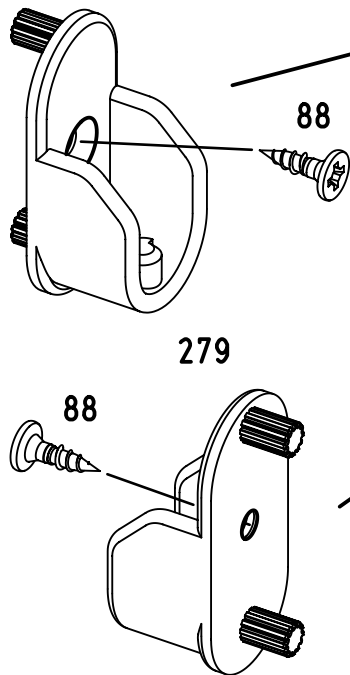
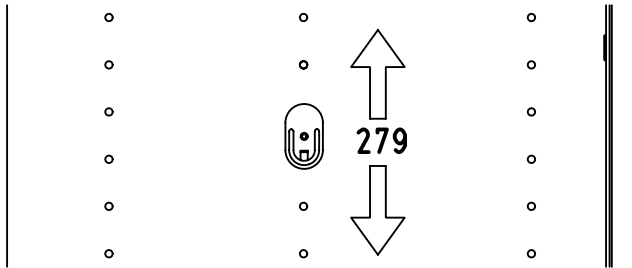
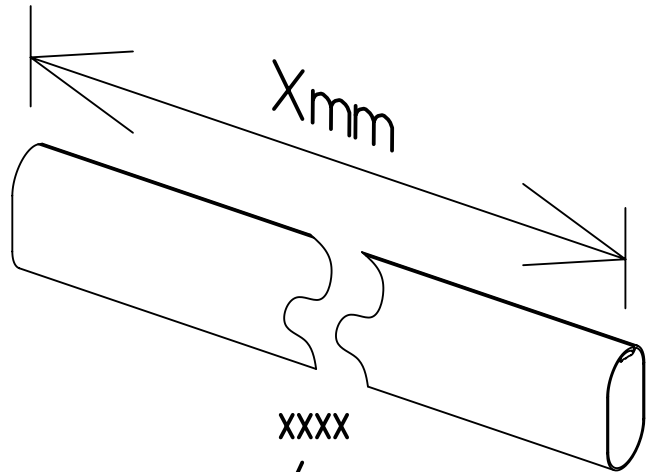

1.

MZ112_02

rauch

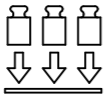
X mm	Y mm	Z mm	 	(XXXX)
432mm	450mm	16mm	max. 10kg	(2143)
656mm	450mm	16mm	max. 10kg	(2145)
848mm	450mm	16mm	max. 10kg	(2149)
880mm	450mm	16mm	max. 10kg	(2147)
1064mm	450mm	22mm	max. 25kg	(2150)

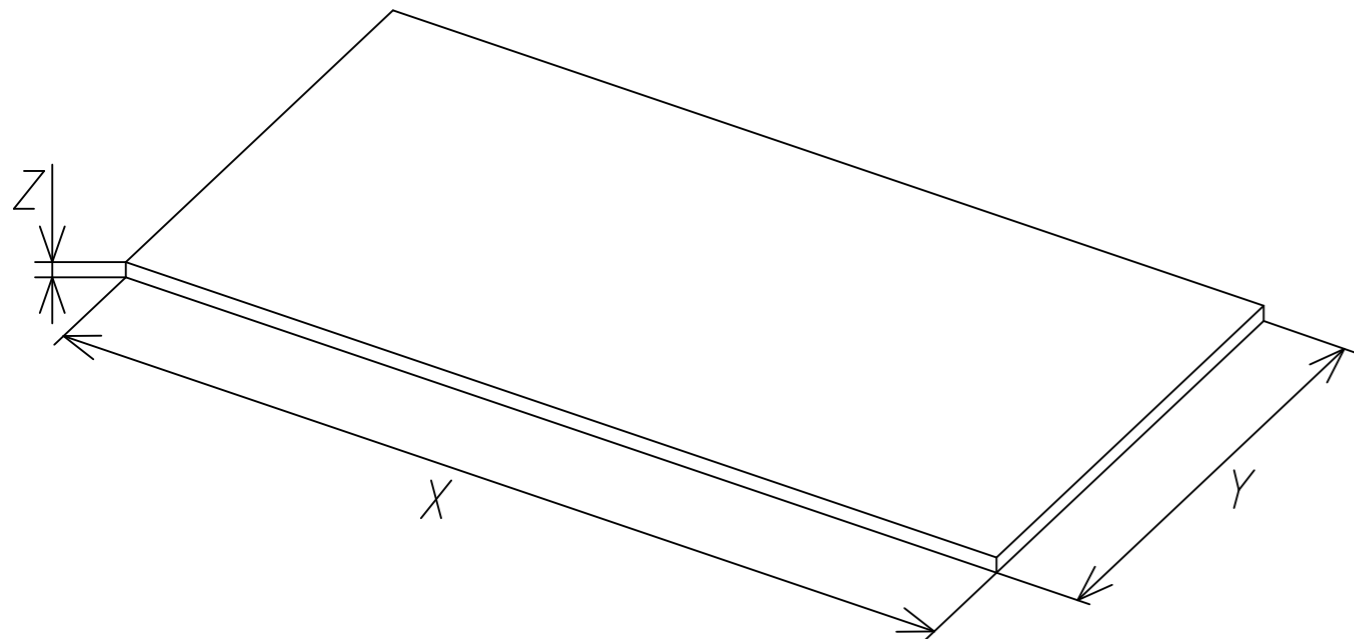

2.

1

4x (1105)

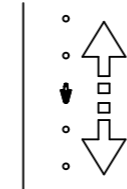
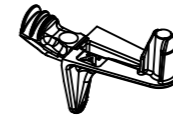

1105

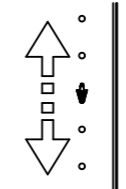
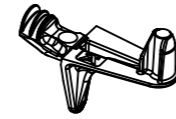

2.

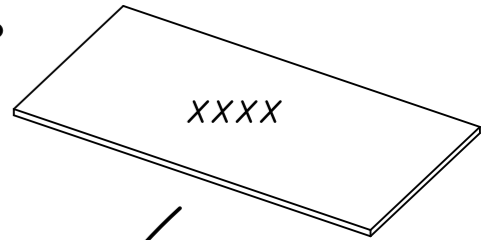

1.

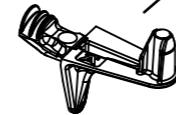

1105

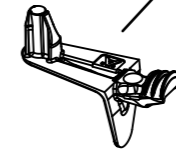

3.

