

Luise

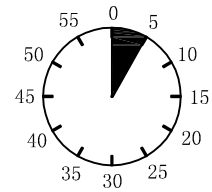

1

2

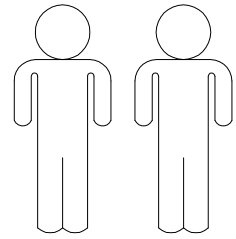
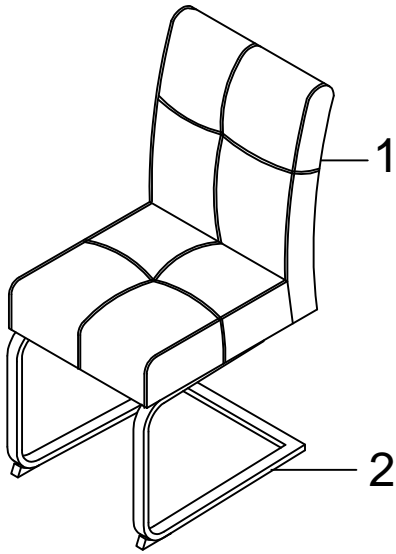
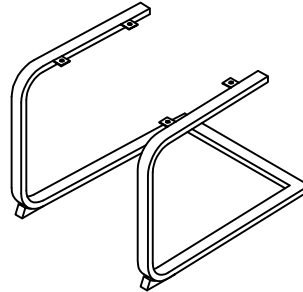
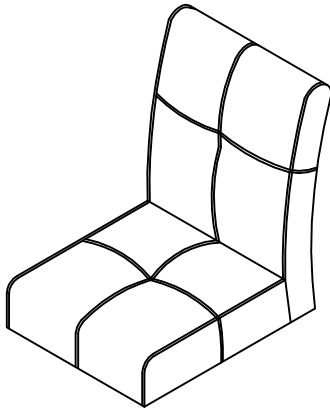

1	1X
2	1X

A

M6*20

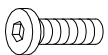

4X

B

Ø18*Ø6.5*1.5



4X





C

4mm

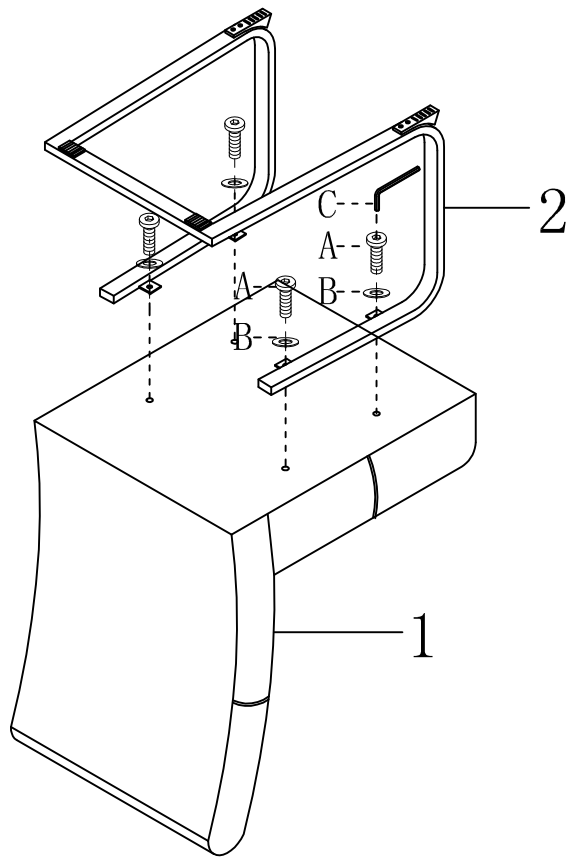



1X

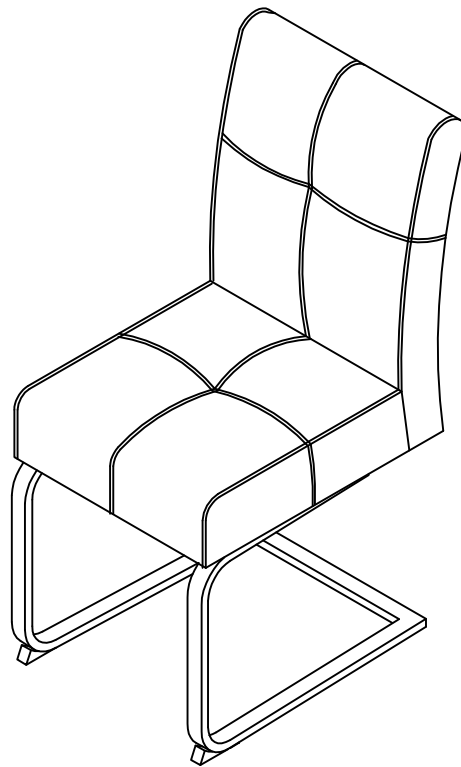

- A  M6*20
4X
 - B  Ø18*Ø6.5*1.5
4X
 - C  4mm
1X
- 

75%



- C  4mm
1X
- 

100%

