

1 → 2 → 3 ...

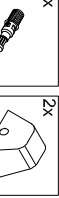

30cm UO 306-6
40cm UO 406-6
50cm UO 506-6
60cm UO 606-6

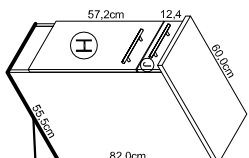
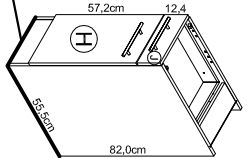

30cm U 306-6
40cm U 406-6
50cm U 506-6
60cm UO 606-6

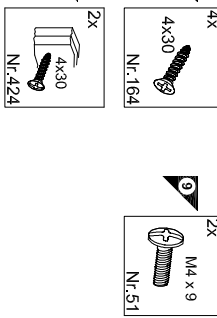
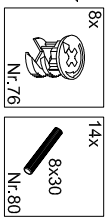
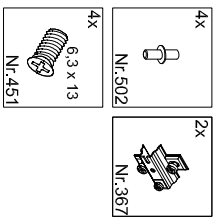

Service-Hotline
01805-678101
0,14€ pro Minute
++49 für Österreich
Auslandstarif pro Minute
service@optifit.de
voor Nederland en België
00800.40119350
benelux@optifit.de

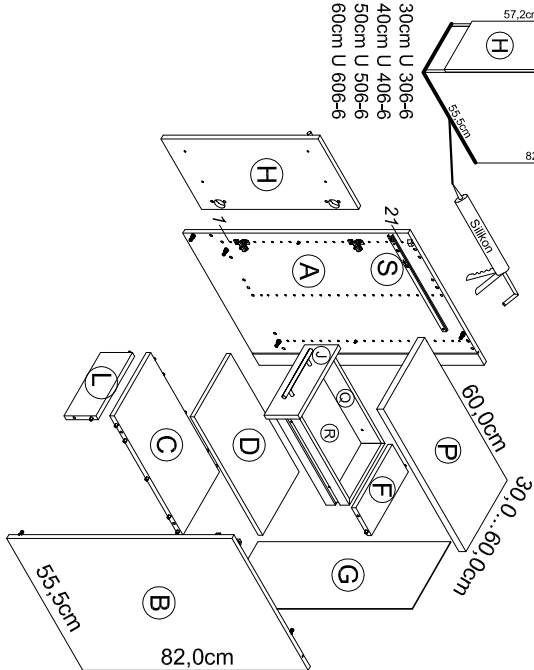

Montageanleitung

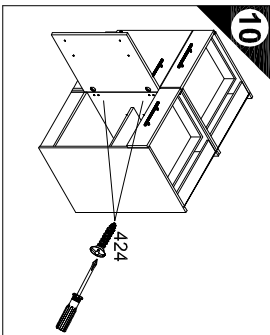
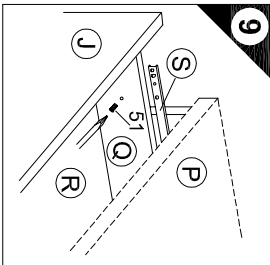
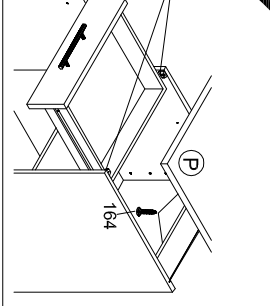
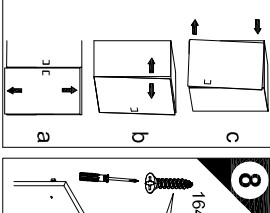
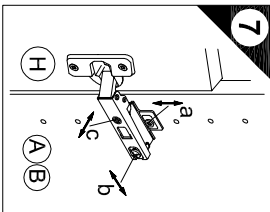
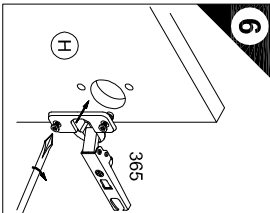
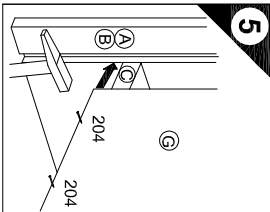
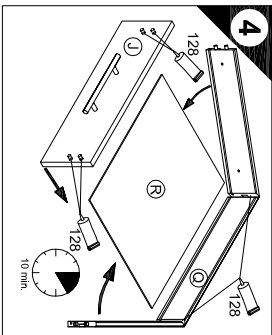
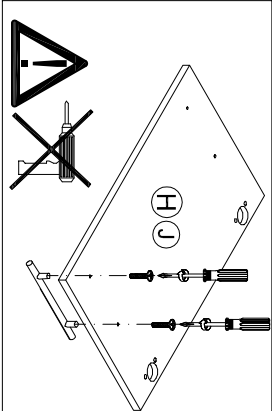
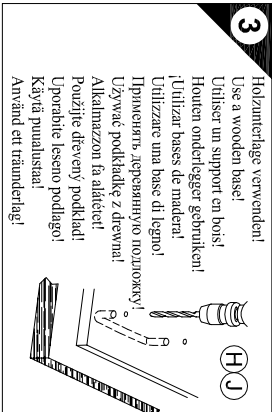
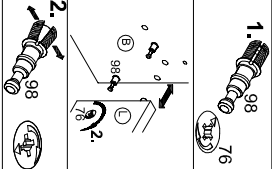
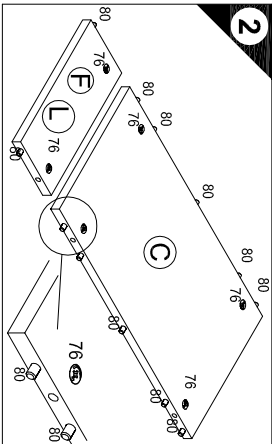
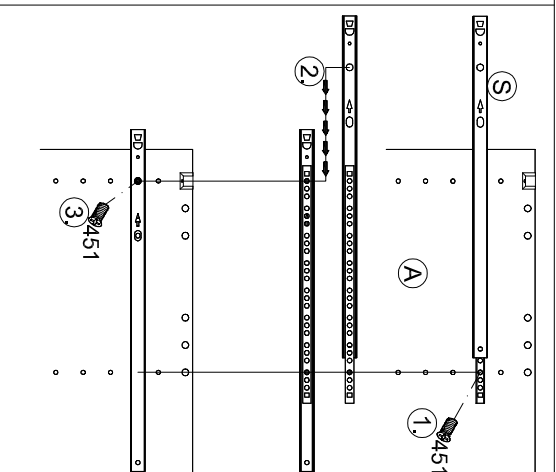
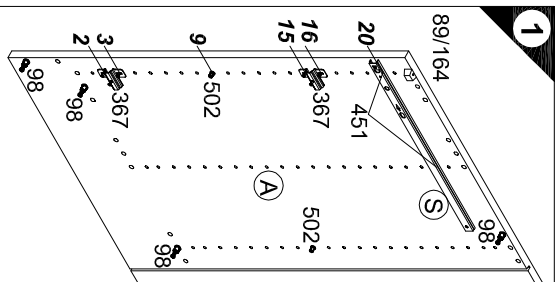

Holzunterlage verwenden!
Use a wooden base!
Utiliser un support en bois!
Houten onderlegger gebruiken!
Utilizar base de madera!
Utilizzare una base di legno!
Применять деревянную подложку!
Uživat ročkovú podložku z dreva!
Alkalimazon la aikielci!
Použít drevený podklad!
Upravljite leseno podlaglo!
Kivált pamlasztal!
Använd ett träunderlag!

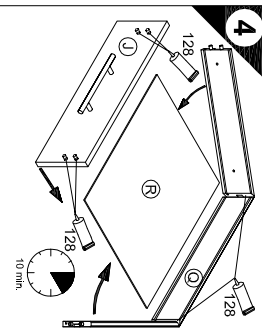
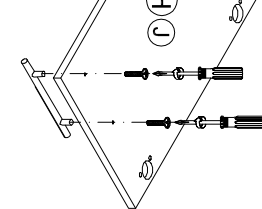
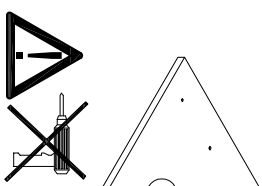

Ersatzteile/Spare parts/pièces de rechange/Reserveonderdelen/Pezas de recambio/Ricambi/Запасные части/Części zamienné/pótalkatészczek/Náhradní části/Nadomestni deli/Varaosat/reservdeklar

- | | | | | | | | | | | | | |
|---------|-------------|-------------|-------------|-------------|-------------|-------------|-------------|-------------|-------------|-------------|-------------|-------------|
| UO306-6 | (A) E961021 | (B) E961022 | (C) E954216 | (D) E950306 | (F) E970976 | (G) E970006 | (H) E980614 | (J) E980565 | (L) E970976 | (Q) E446130 | (R) E971153 | (S) E446205 |
| U306-6 | (A) E961021 | (B) E961022 | (C) E954216 | (D) E950306 | (F) E970976 | (G) E970006 | (H) E980614 | (J) E980565 | (L) E970976 | (Q) E441106 | (R) E971153 | (S) E446205 |
| UO406-6 | (A) E961021 | (B) E961022 | (C) E954215 | (D) E950305 | (F) E970975 | (G) E970010 | (H) E980613 | (J) E980564 | (L) E970975 | (Q) E446131 | (R) E971152 | (S) E446205 |
| U406-6 | (A) E961021 | (B) E961022 | (C) E954215 | (D) E950305 | (F) E970975 | (G) E970010 | (H) E980613 | (J) E980564 | (L) E970975 | (Q) E441105 | (R) E971152 | (S) E446205 |
| UO506-6 | (A) E961021 | (B) E961022 | (C) E954224 | (D) E950304 | (F) E970974 | (G) E970117 | (H) E980612 | (J) E980563 | (L) E970974 | (Q) E446132 | (R) E971151 | (S) E446205 |
| U506-6 | (A) E961021 | (B) E961022 | (C) E954224 | (D) E950304 | (F) E970974 | (G) E970117 | (H) E980612 | (J) E980563 | (L) E970974 | (Q) E441104 | (R) E971150 | (S) E446205 |
| UO606-6 | (A) E961021 | (B) E961022 | (C) E954223 | (D) E950303 | (F) E970973 | (G) E970116 | (H) E980611 | (J) E980562 | (L) E970973 | (Q) E446133 | (R) E971150 | (S) E446205 |
| U606-6 | (A) E961021 | (B) E961022 | (C) E954223 | (D) E950303 | (F) E970973 | (G) E970116 | (H) E980611 | (J) E980562 | (L) E970973 | (Q) E441103 | (R) E971150 | (S) E446205 |

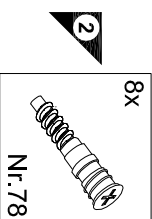
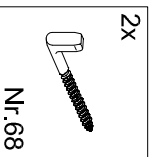
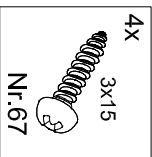
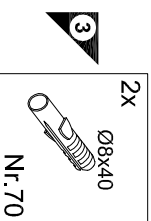
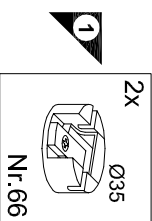
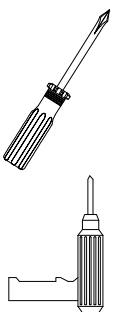

Montageanleitung

RP587+

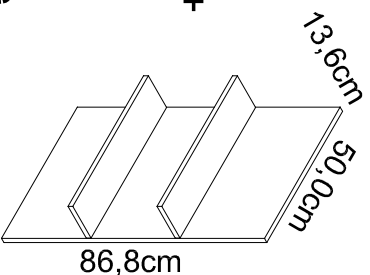

Service-Hotline
01805-678101
0,14€ pro Minute
++49 für Österreich
Auslandstarif pro Minute
service@jaka-bkl.de
voor Nederland en België
00800-40119350
benelux@jaka-bkl.de

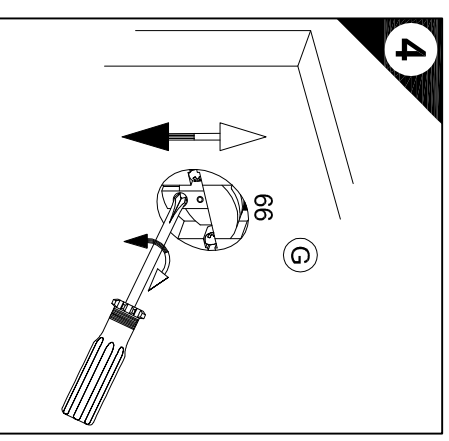
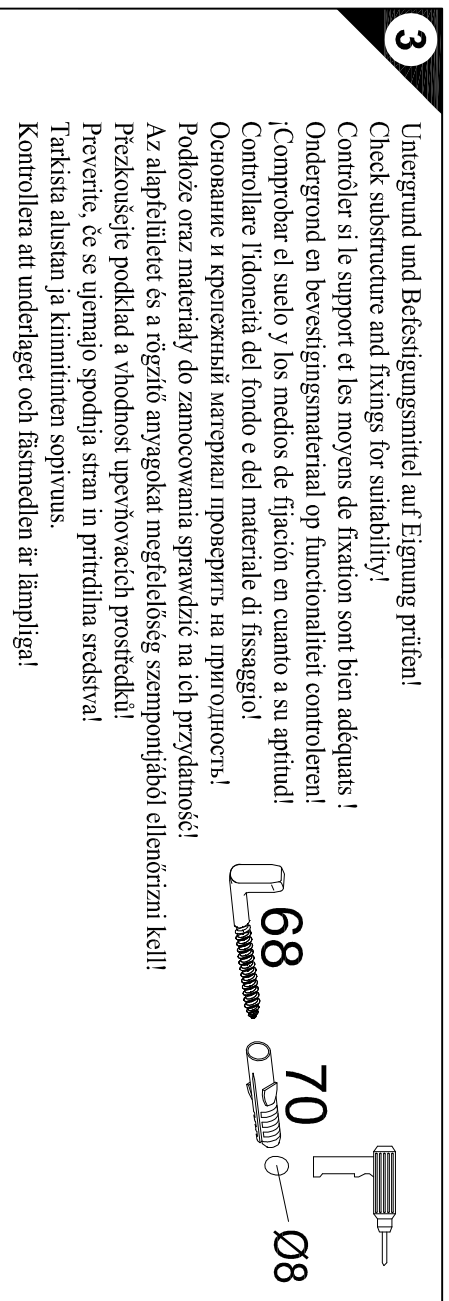
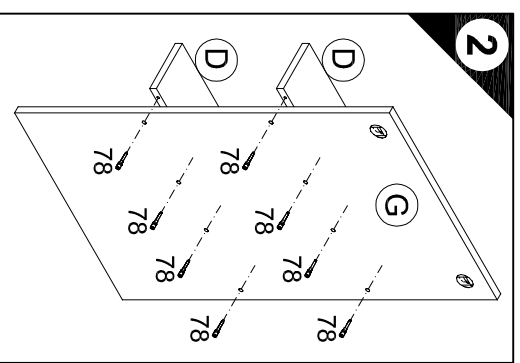
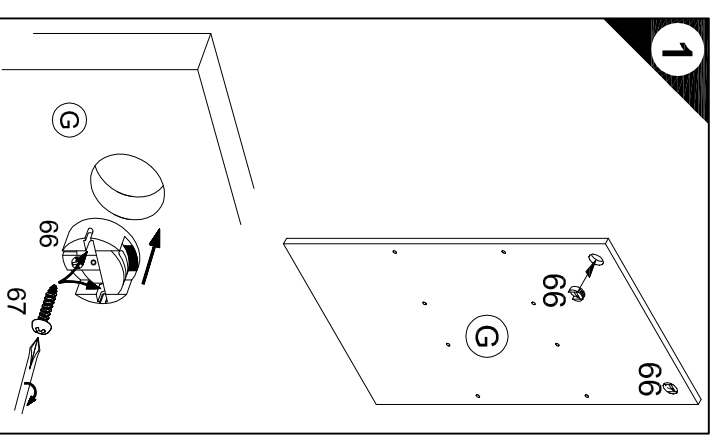
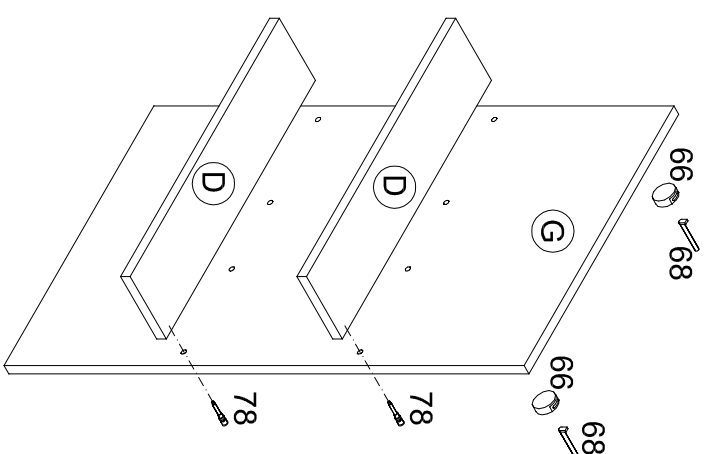

Ersatzteile/Spare parts/pièces de rechange/Reserveonderdelen/Piezas de recambio/Ricambi/Запасные части/Części zamienne/pótalakrészek/Náhradní části/Nadomestni deli/Varaosat/reservdelar

RP587+ | **D** E940137 **G** E940136

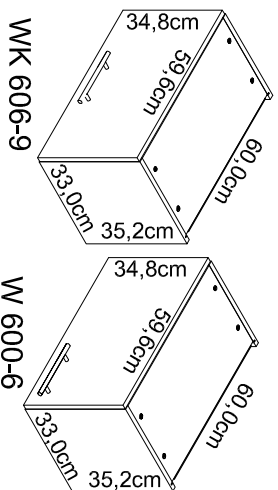
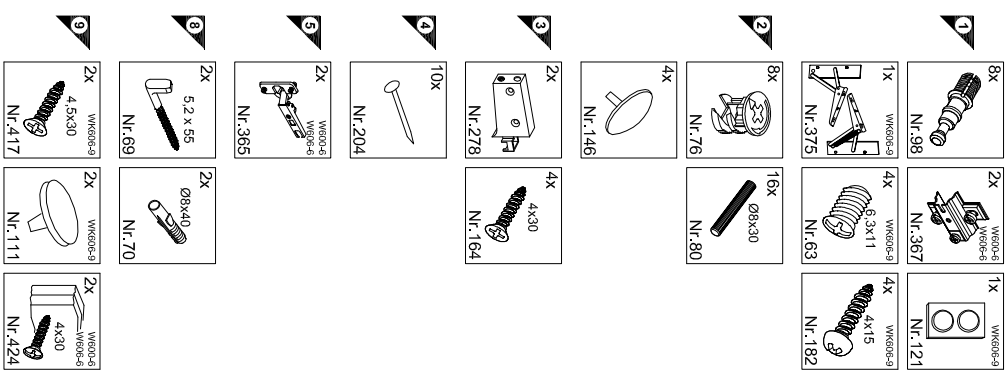
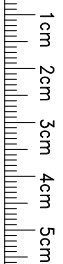

WK 606-9
W 600-6
W 606-6

Service-Hotline
01805-678101

0,14€ pro Min.
++49 für Österreich

Auslandschaft pro Min.
service@optifit.de
voor Nederland en België
00800-40119350
benelux@optifit.de

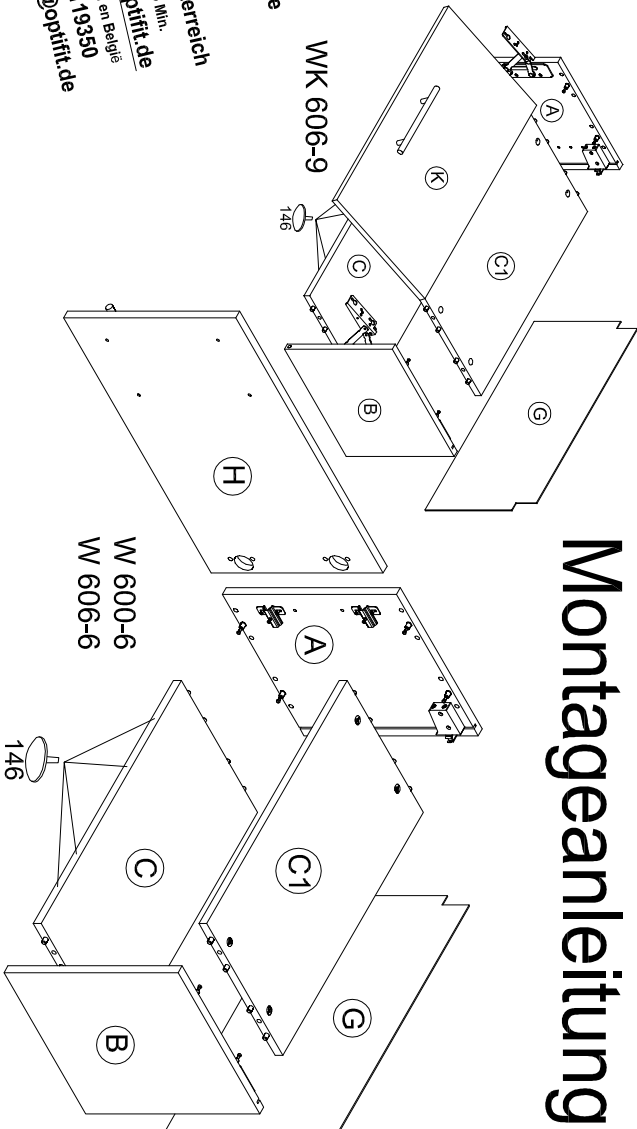

Montageanleitung

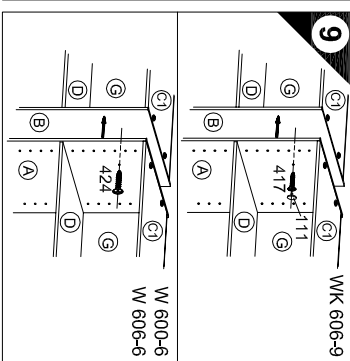
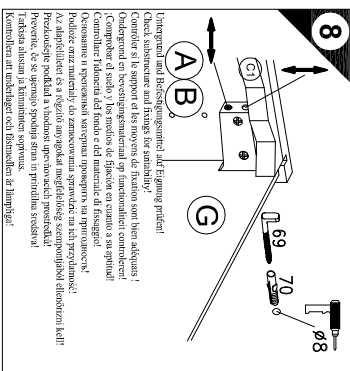
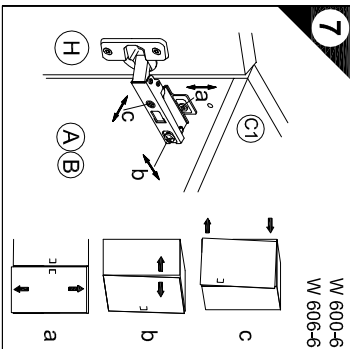
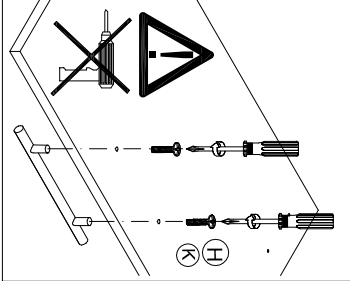
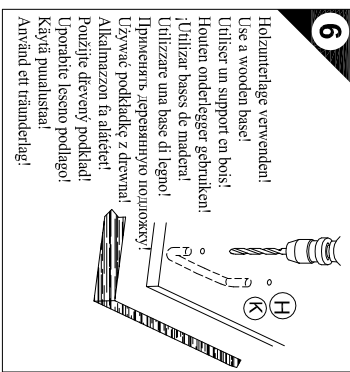
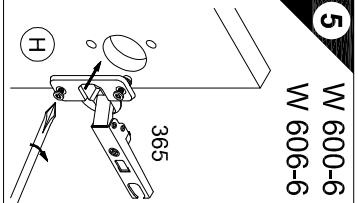
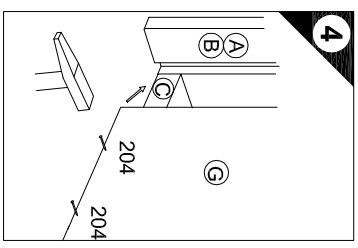
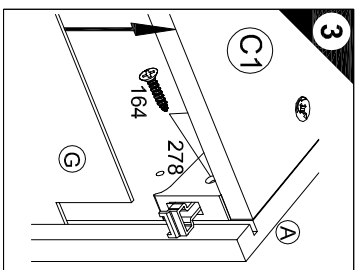
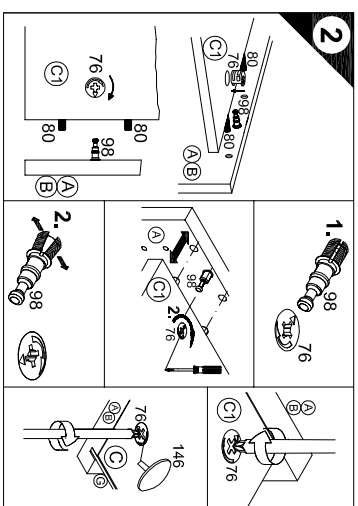
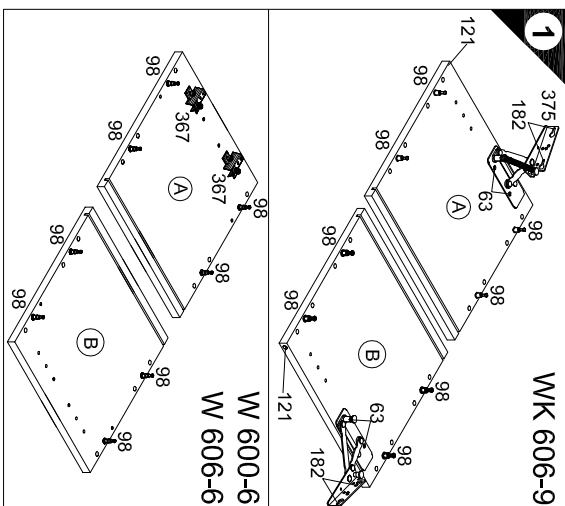

6
Holzunterlage verwenden!
Use a wooden base!
Utiliser un support en bois!
Houten onderlegger gebruiken!
Utilizar bases de madeira!
Применять деревянную подложку!
Utilizzare una base di legno!
Uživajte podložku z dřevom!
Akalhazozon fa alátvány!
Pouzijte dřevěný podklad!
Upravljajite leseno podlaglo!
Käytävä puuhastai!
Använd ett träunderlag!

8
Untergrund und Bekleidungsunterlage festfügung prüfen!
Check substrate and frame for stability!
Contrôler si le support et les revêtements sont bien adhérents!
Controllare se il supporto, le moquette e i dati materiali di fissaggio!
Controllare il rivestimento del fondo e i dati materiali di fissaggio!
Controllare in prova il rivestimento, soprattutto il parquet, sia prima che dopo il montaggio!
Aztalig ellenőrizni a talaj és a burkolat rögzítését, még a szerelés előtt és után!
Prekontrolirati podlogu i podlogu prekrivača, posebno parket, prije i nakon montaže!
Kontrollera om underlaget och klädningsunderlaget är fästade ordentligt!

Ersatzteile/Spare parts/pièces de rechange/Reserveonderdelen/Piezas de recambio/Ricambi/Запасные части/Části/zámenné/prísluškátárszék/Náhradní části/Nadomestini deli/varaosat/reservedlar

60cm WK 606-9 | A E940034 B E940034 C E941233 C E941233 G E970038 K E940700

60cm W600-6 / W606-6 | A E940034 B E940034 C E941233 C E941233 G E970038 H E980556

SERVICEKARTE

VH

Liebe Kundin, lieber Kunde,

obwohl wir unsere Möbel vor der Auslieferung einer eingehenden Endkontrolle unterziehen, kann es vorkommen, dass einmal ein Zubehörteil fehlt oder während des Transports beschädigt wird. Senden sie den Artikel bitte nicht zurück, sondern fordern sie einfach Ersatz für das Einzelteil bei unserer Kundenhotline an. Die Telefonnummern finden sie auf den Serviceseiten im Katalog.

Bitte benennen sie die Teile wie sie auf ihrer Aufbauanleitung angegeben sind. Fügen sie auch **Artikelnummer, Modellnamen und Farbnummer** bei. **Siehe Beispiel.**

Wir werden ihre Anforderung sofort bearbeiten und ihnen das Ersatzteil umgehend zusenden.

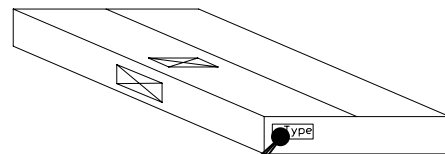
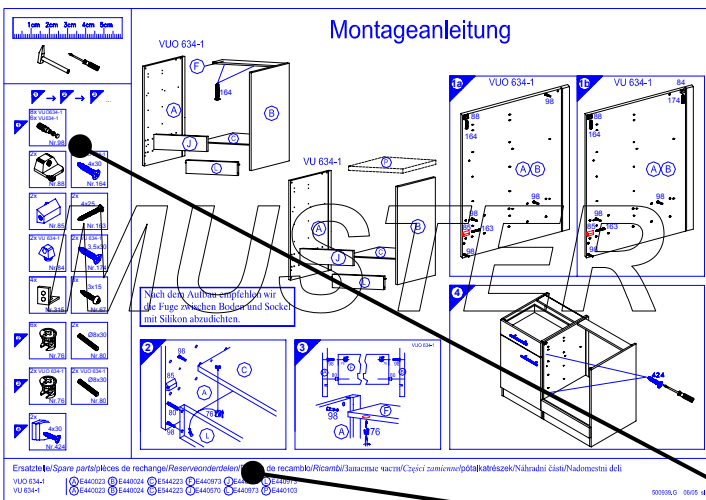

Muster - Bestellung		
Artikelnummer	123 456	
Modellname	Unterschrank VU634	
Farbe	TA 01	
Benötigte Ersatzteile:		
Bezeichnung	Nr.	Anzahl
Beschlagteil	98	2
Teil B	E 440 023	1

Bitte entnehmen sie die notwendige Ersatzteilnummer der Aufbauanleitung die zum Möbel gehört!

Kundendaten	
Kundennummer	
Name	
Vorname	
Strasse	
Haus-Nr.	
PLZ	
Ort	
Rechnungsdatum	
Tel. für Rückfragen	
Notizen:	

Ersatzteilbestellung		
Artikelnummer		
Modellname		
Farbe		
Benötigte Ersatzteile:		
Bezeichnung	Nr.	Anzahl
Grund der Ersatzteilanforderung:		