

- (D) Montageanleitung
- (NL) Handleiding voor de montage
- (HU) Szerelési útmutató
- (GB) Assembly instructions
- (PL) Instrukcja montażu

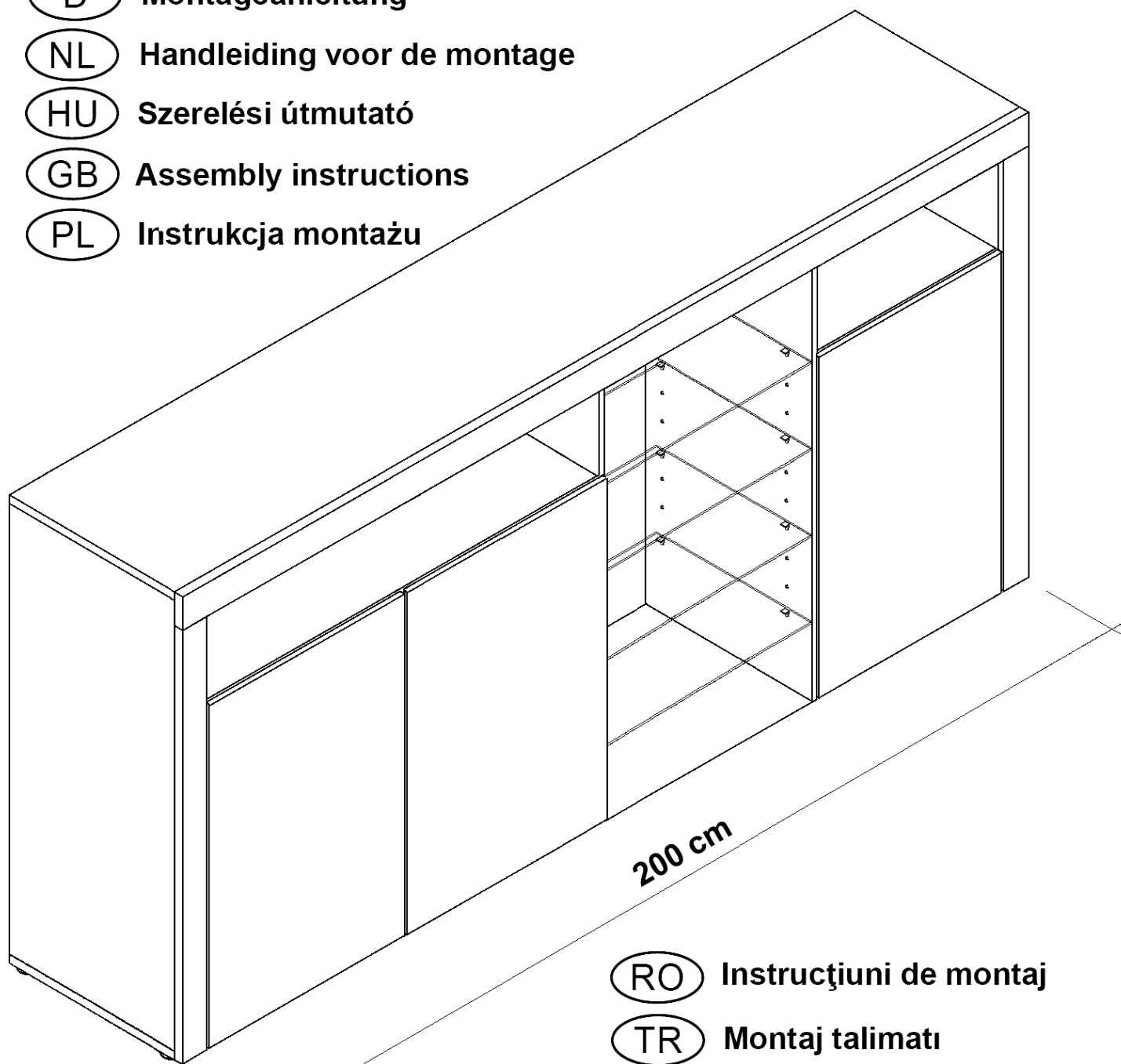

- (RO) Instrucțiuni de montaj
- (TR) Montaj talimatı
- (IT) Istruzioni di montaggio
- (SK) Návod na montáž
- (RU) Инструкция по монтажу
- (FR) Notice de montage
- (CZ) Montážní návod

Service • Assistenza • Dienstverlening • Serwis Servis • Szerviz • Сервисная служба

Name • Nom • Nome • Naam •
Nazwa • Jméno • Názov • Név •
Denumire • Ísim • Название

Nr. • No. • N° • Номер • Č • Sz

Тур • Туре • Тір • Тípus • Тíро •
Тип

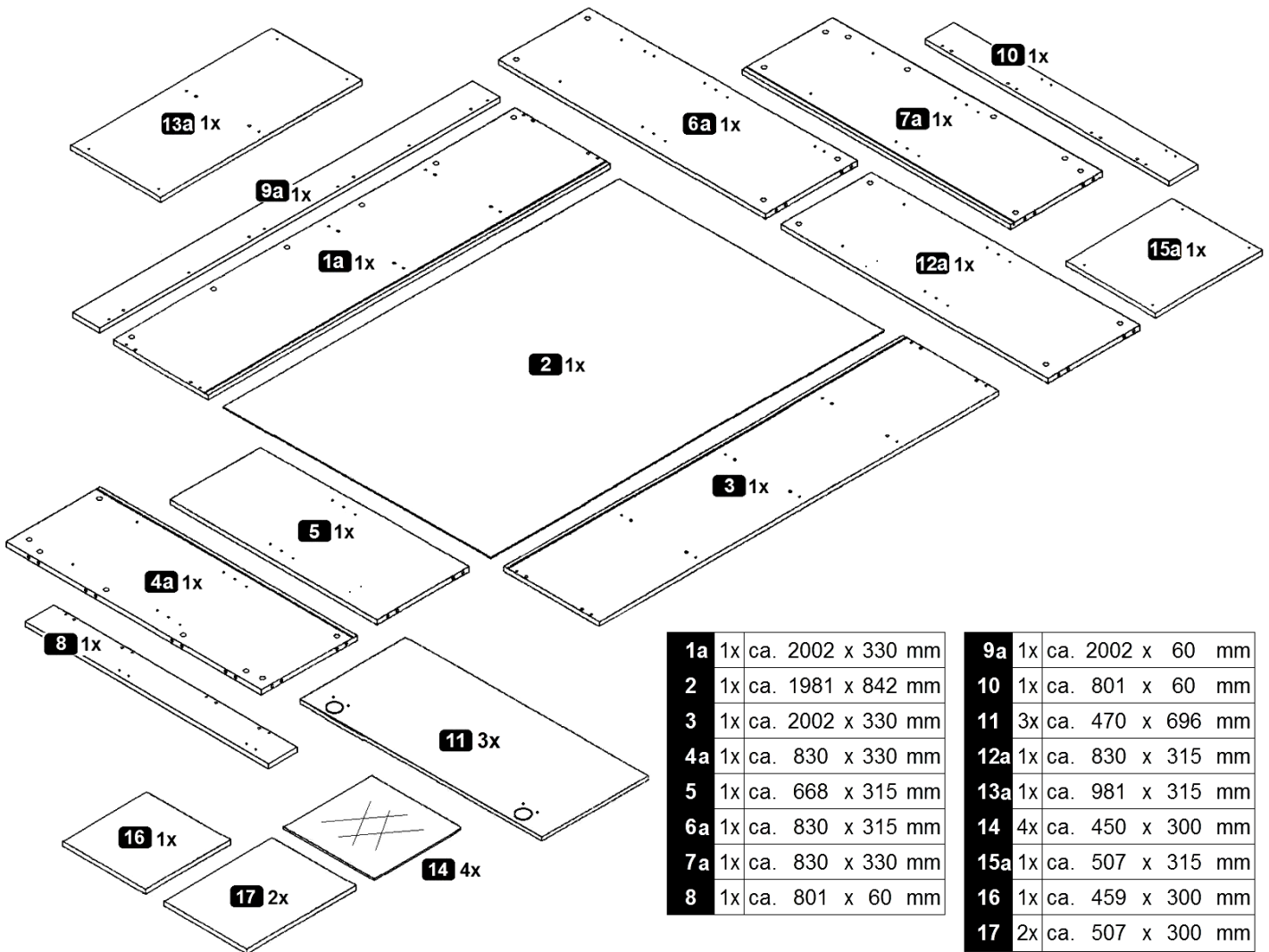
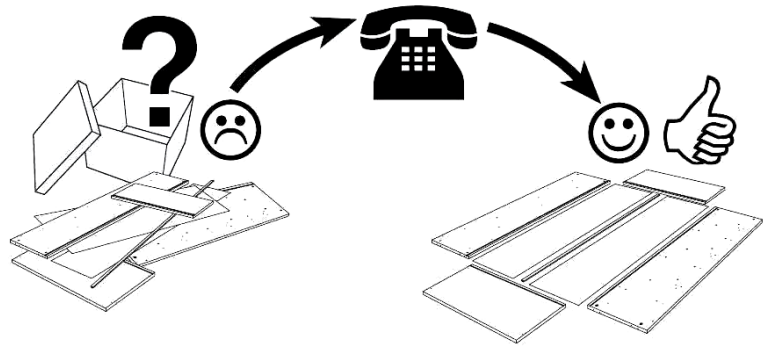
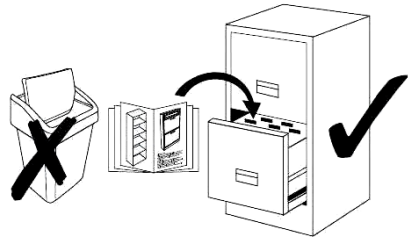



1a	1x	ca. 2002 x 330 mm
2	1x	ca. 1981 x 842 mm
3	1x	ca. 2002 x 330 mm
4a	1x	ca. 830 x 330 mm
5	1x	ca. 668 x 315 mm
6a	1x	ca. 830 x 315 mm
7a	1x	ca. 830 x 330 mm
8	1x	ca. 801 x 60 mm

9a	1x	ca. 2002 x 60 mm
10	1x	ca. 801 x 60 mm
11	3x	ca. 470 x 696 mm
12a	1x	ca. 830 x 315 mm
13a	1x	ca. 981 x 315 mm
14	4x	ca. 450 x 300 mm
15a	1x	ca. 507 x 315 mm
16	1x	ca. 459 x 300 mm
17	2x	ca. 507 x 300 mm

A 8,0 x 30 mm 32x	B 34x	C 34x	D 3,5x9,5mm 3x	E Kr. 8 Ø 35 2x	F 28x	G Spez. → E h=2 2x
H Ø35 4x	I 7x	J 4,0 x 20 mm 7x	K 2,7 x 20 mm 12x	L 8x		



1

A 8,0 x 30 mm  4x	B  14x	C  6x
--	---	--

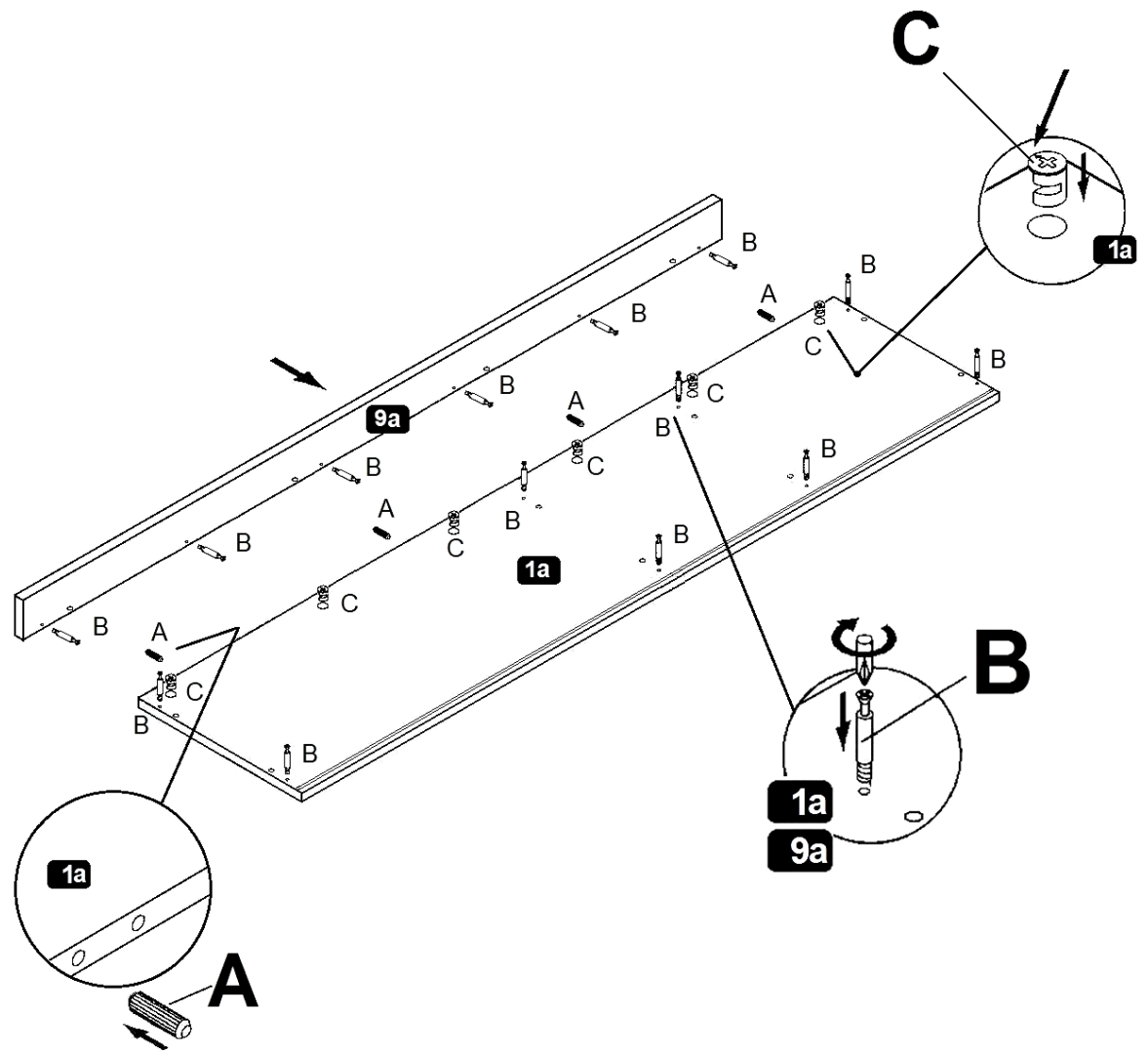
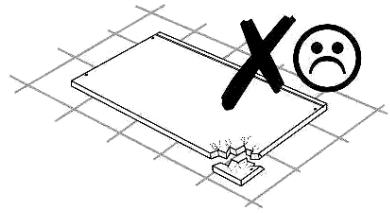
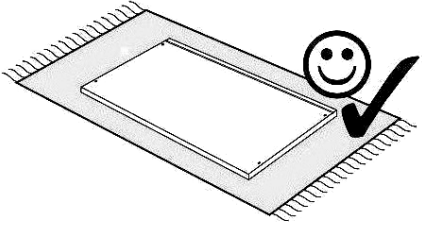
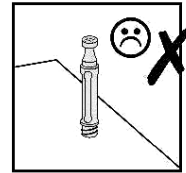
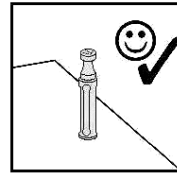

2

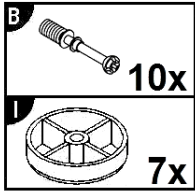
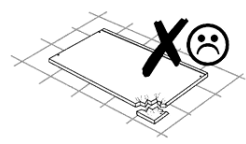
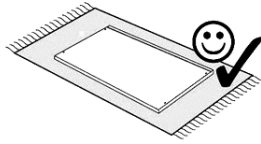
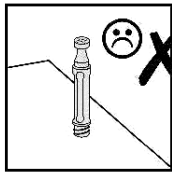
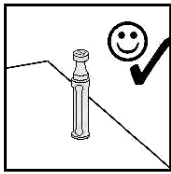

10x

7x

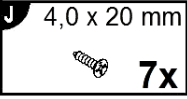

4,0 x 20 mm

7x

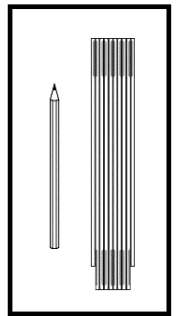
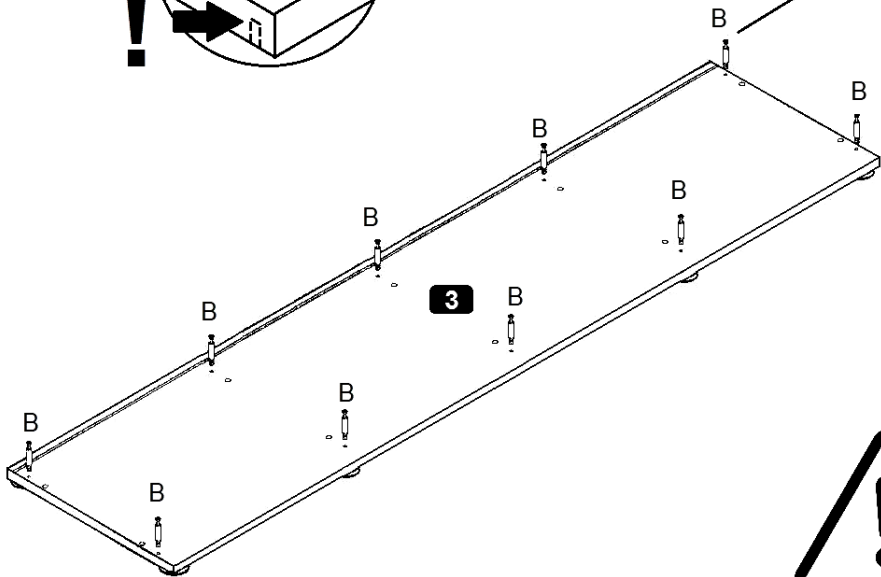
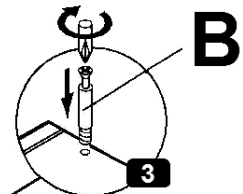
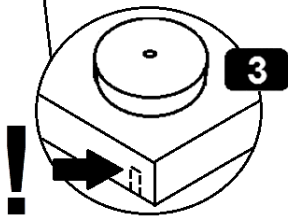
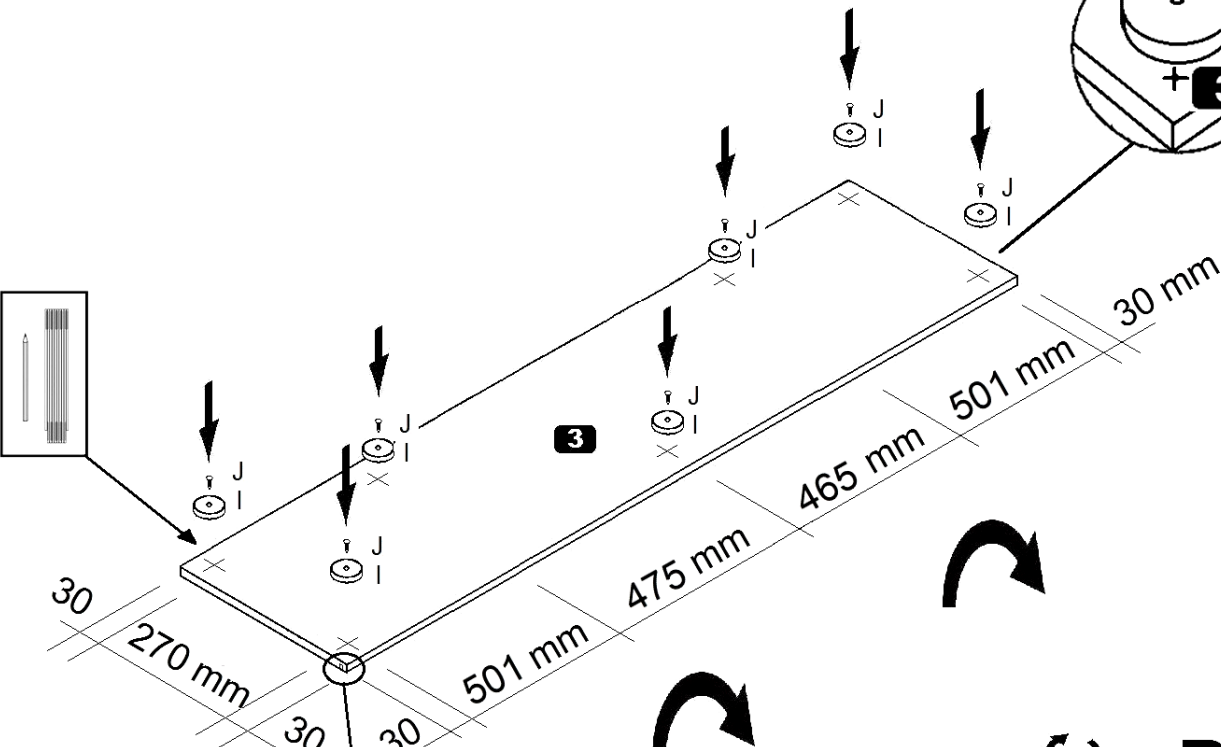

3



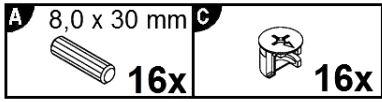

A 8,0 x 30 mm **C**

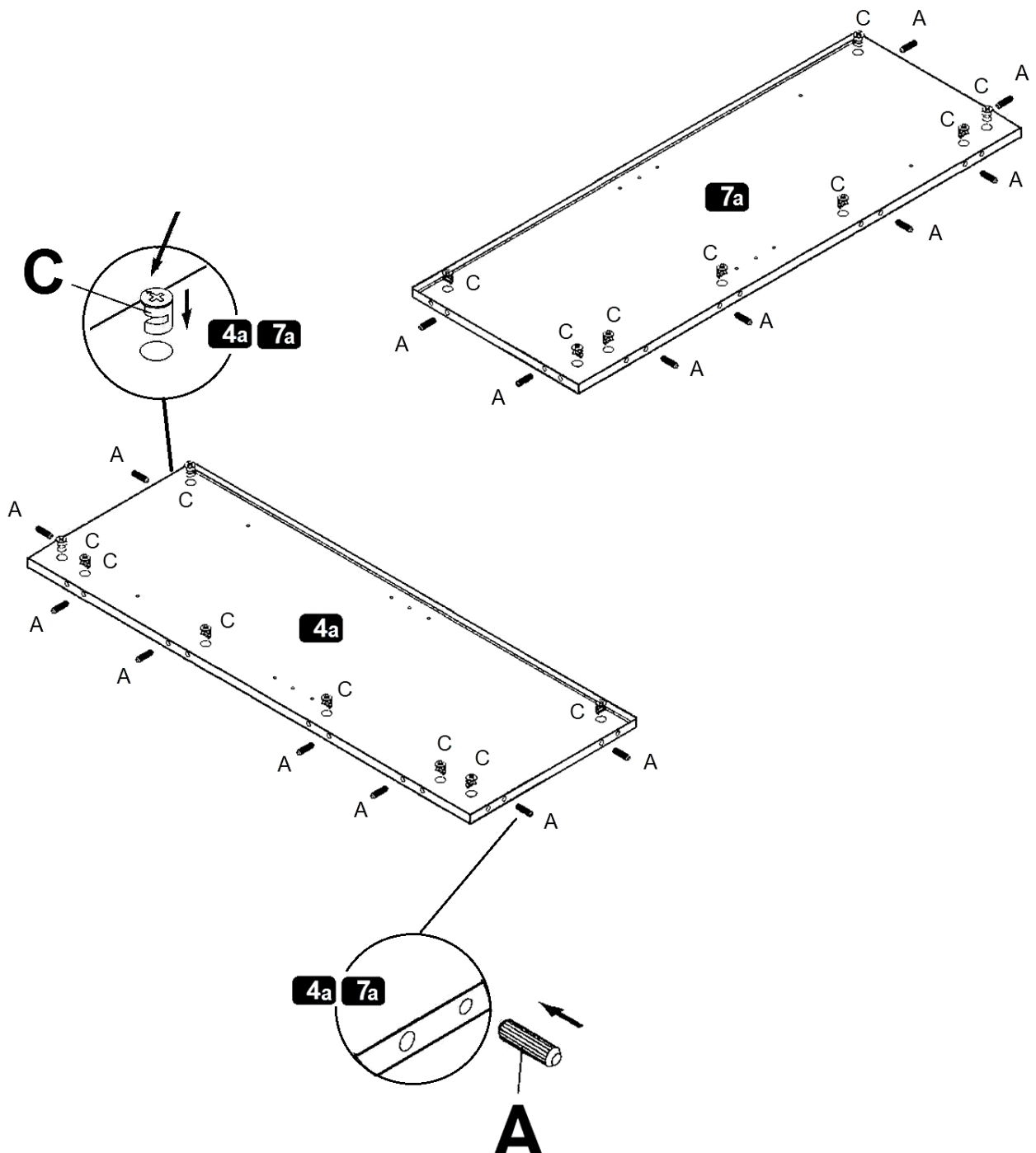
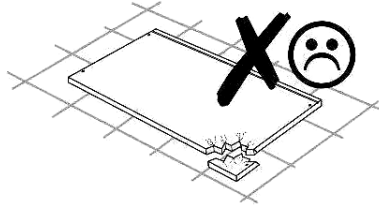
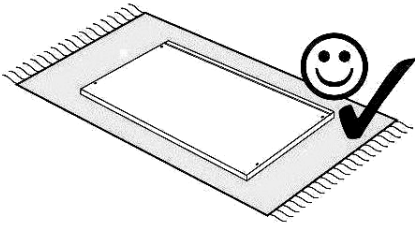
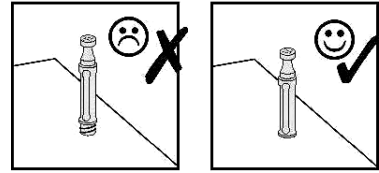

16x 16x



4

A 8,0 x 30 mm	B	C	D 3,5x9,5mm
 8x	 2x	 8x	 2x

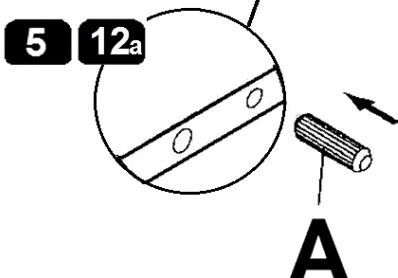
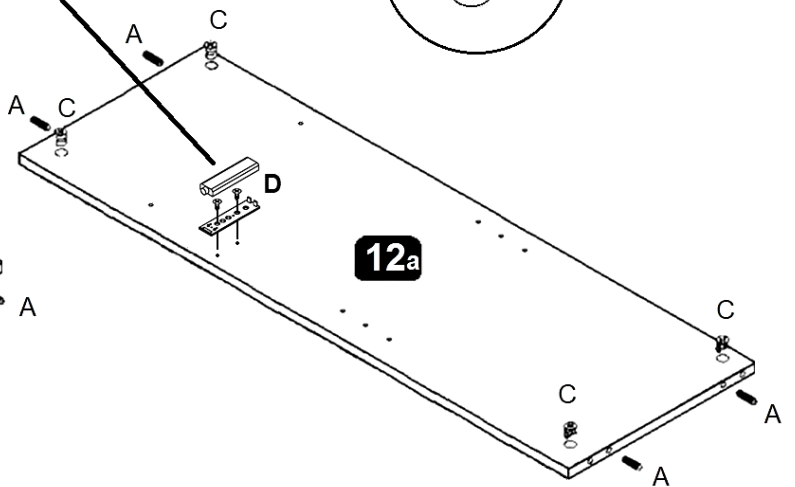
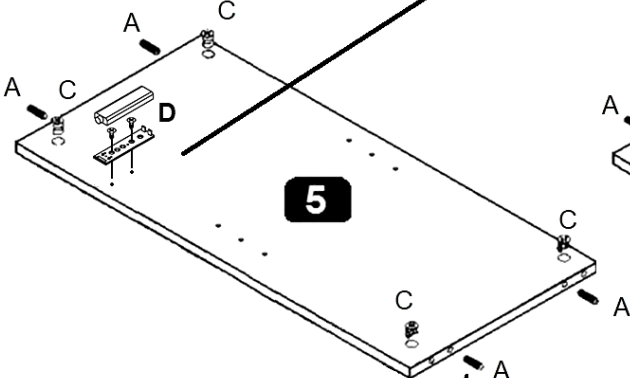
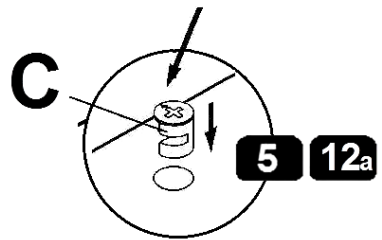
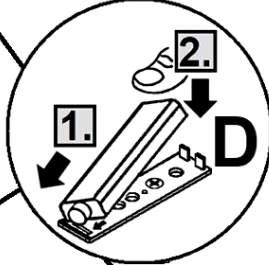
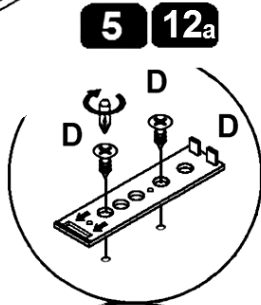
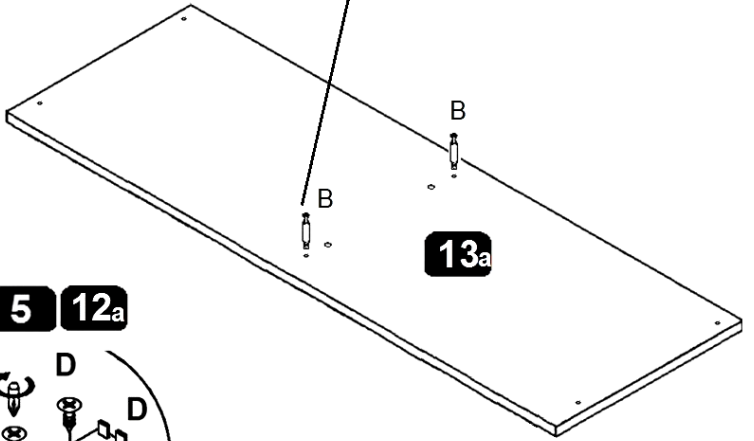
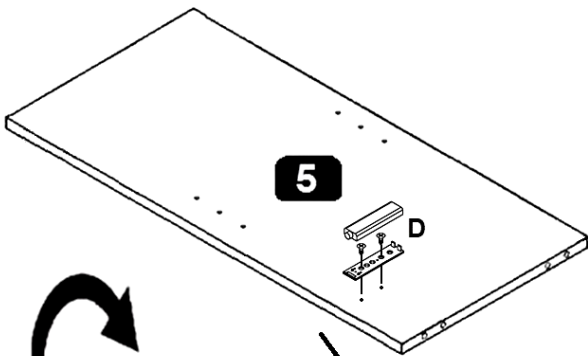
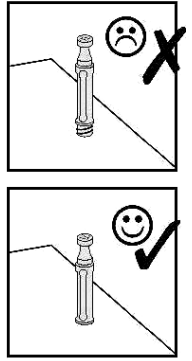
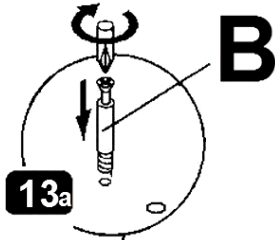
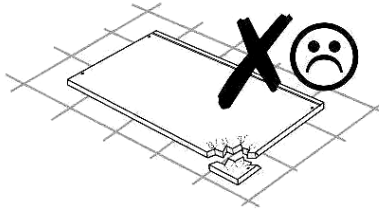
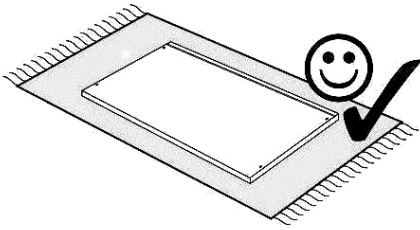

5

A 8,0 x 30 mm **C** **G** Spez. → E
4x 4x h=2 2x

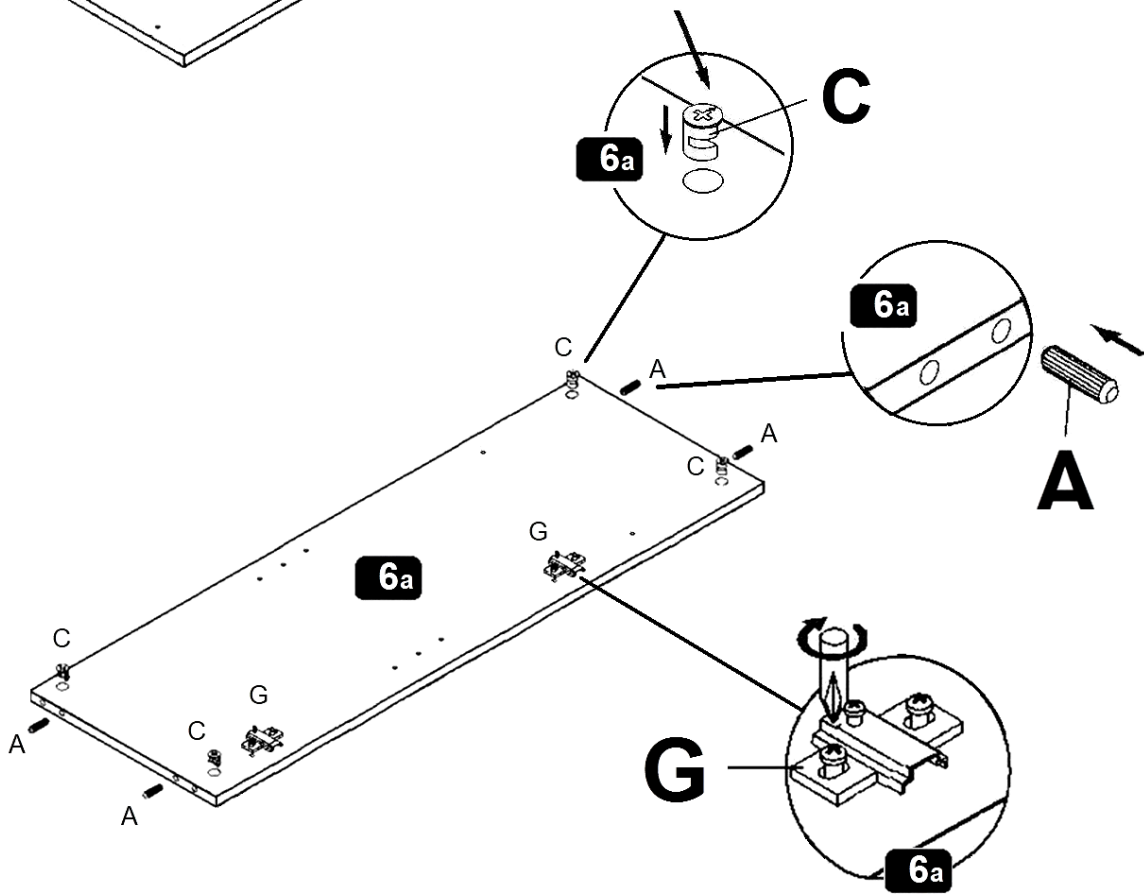
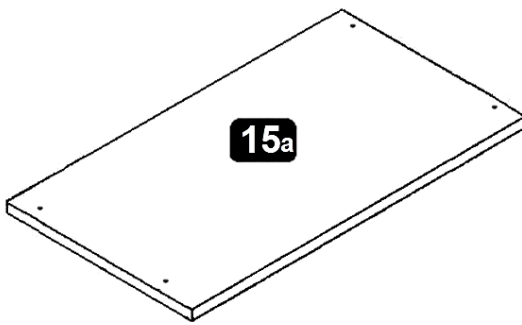
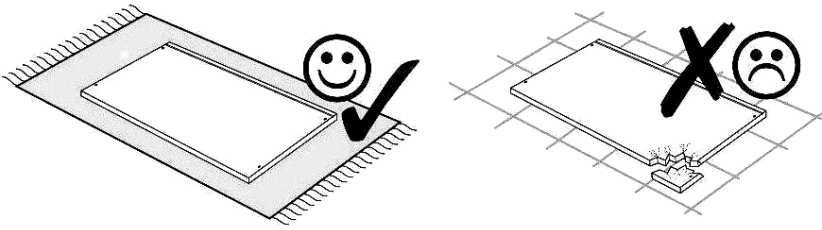
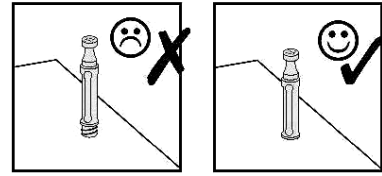

6

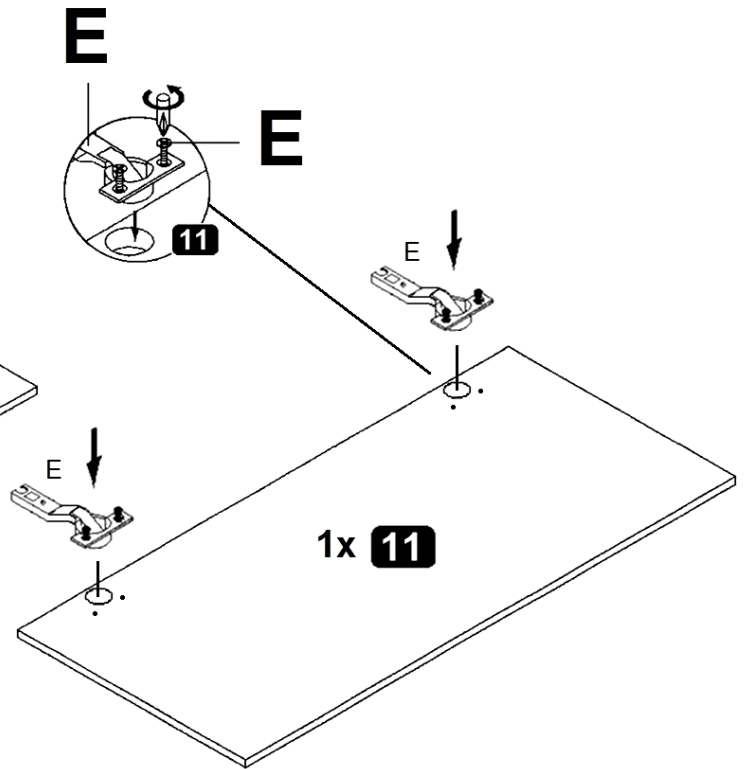
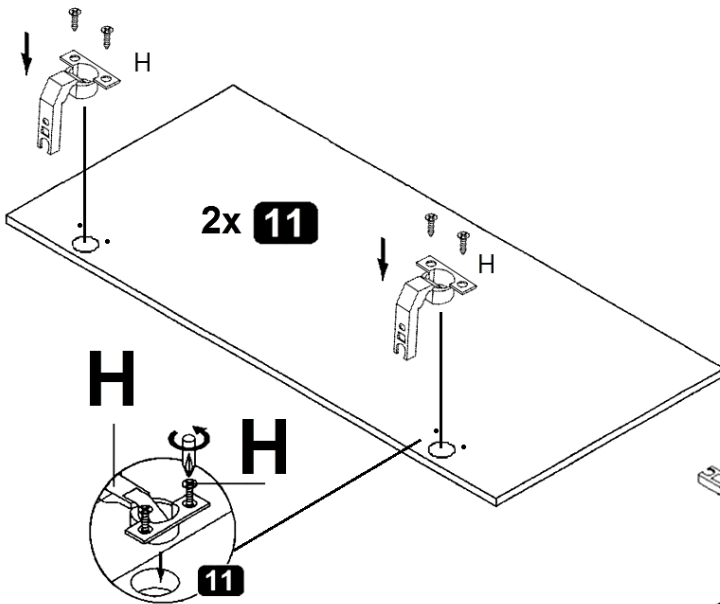
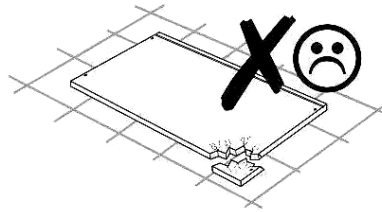
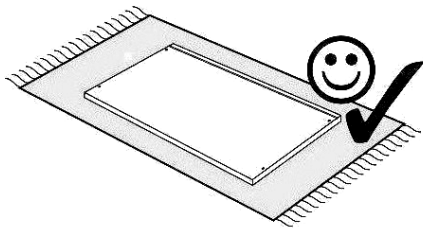
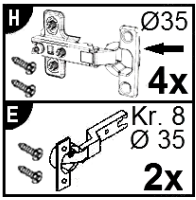

7

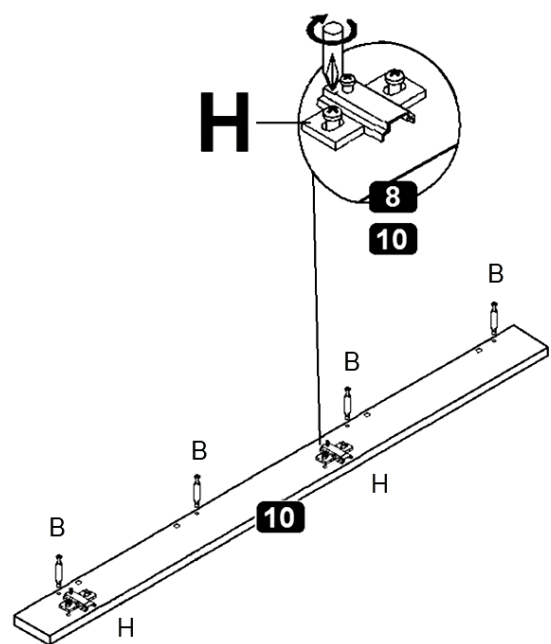
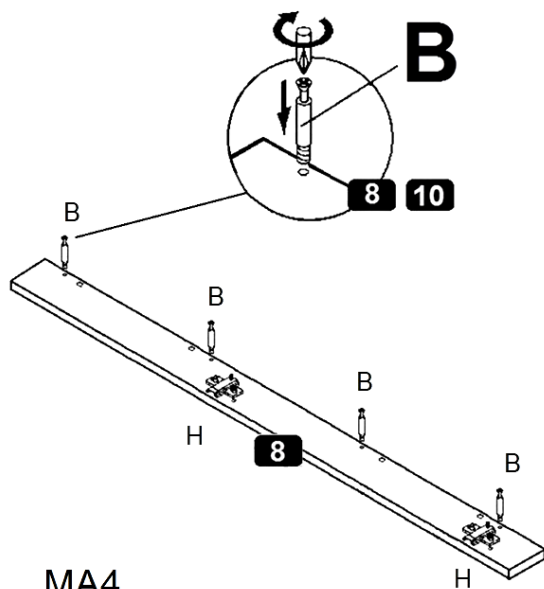
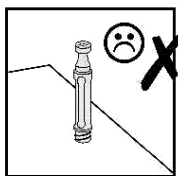
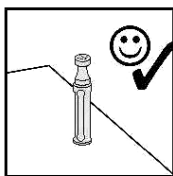
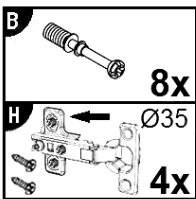

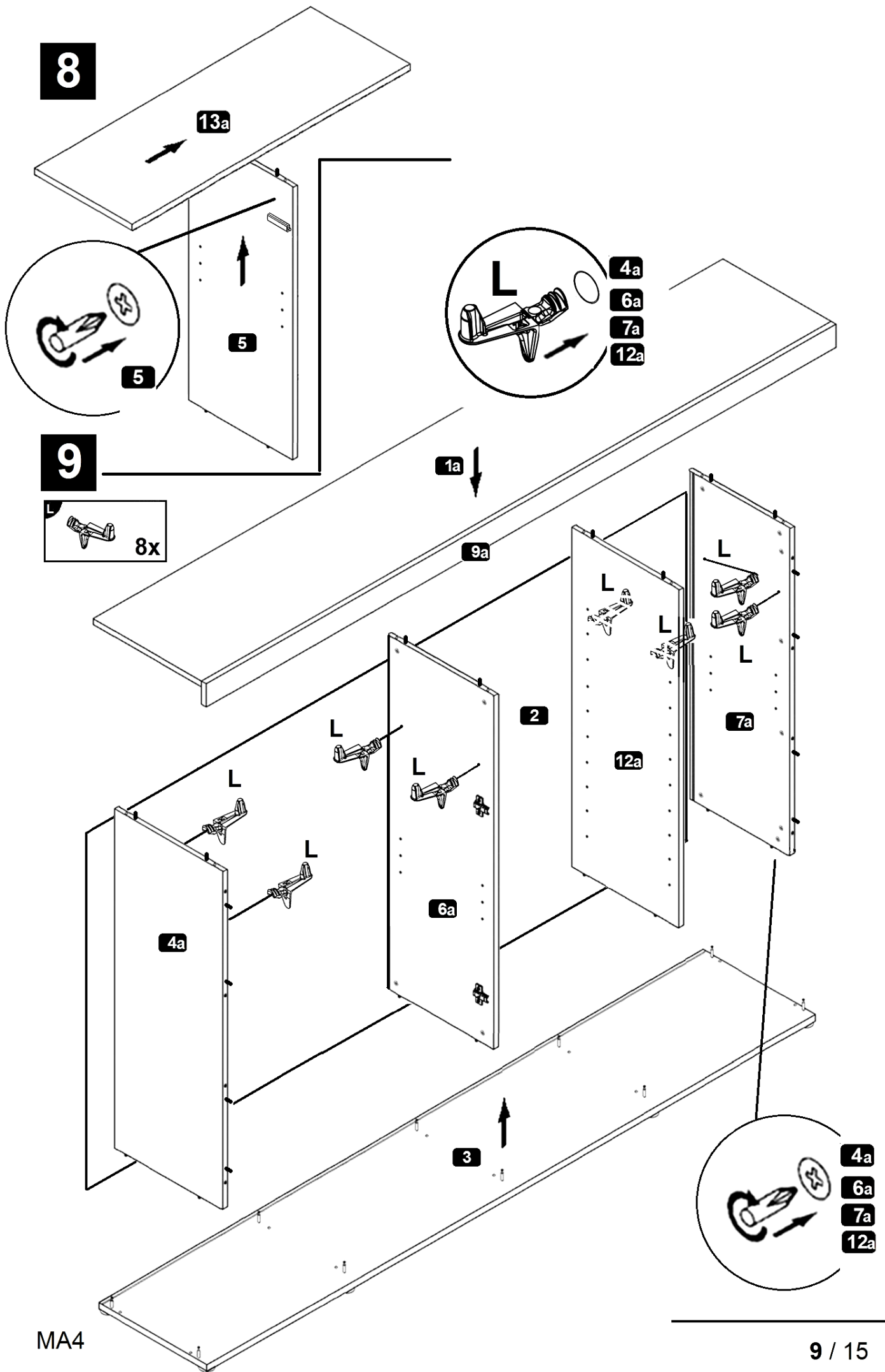

10

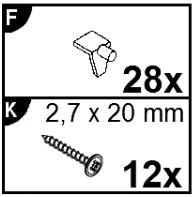

1.

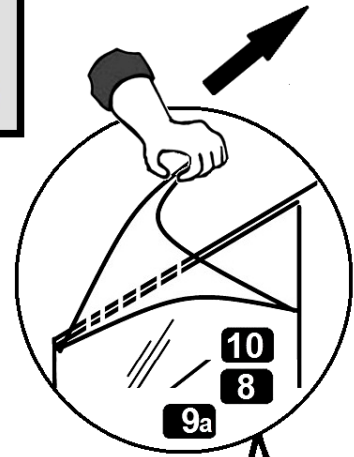

4.

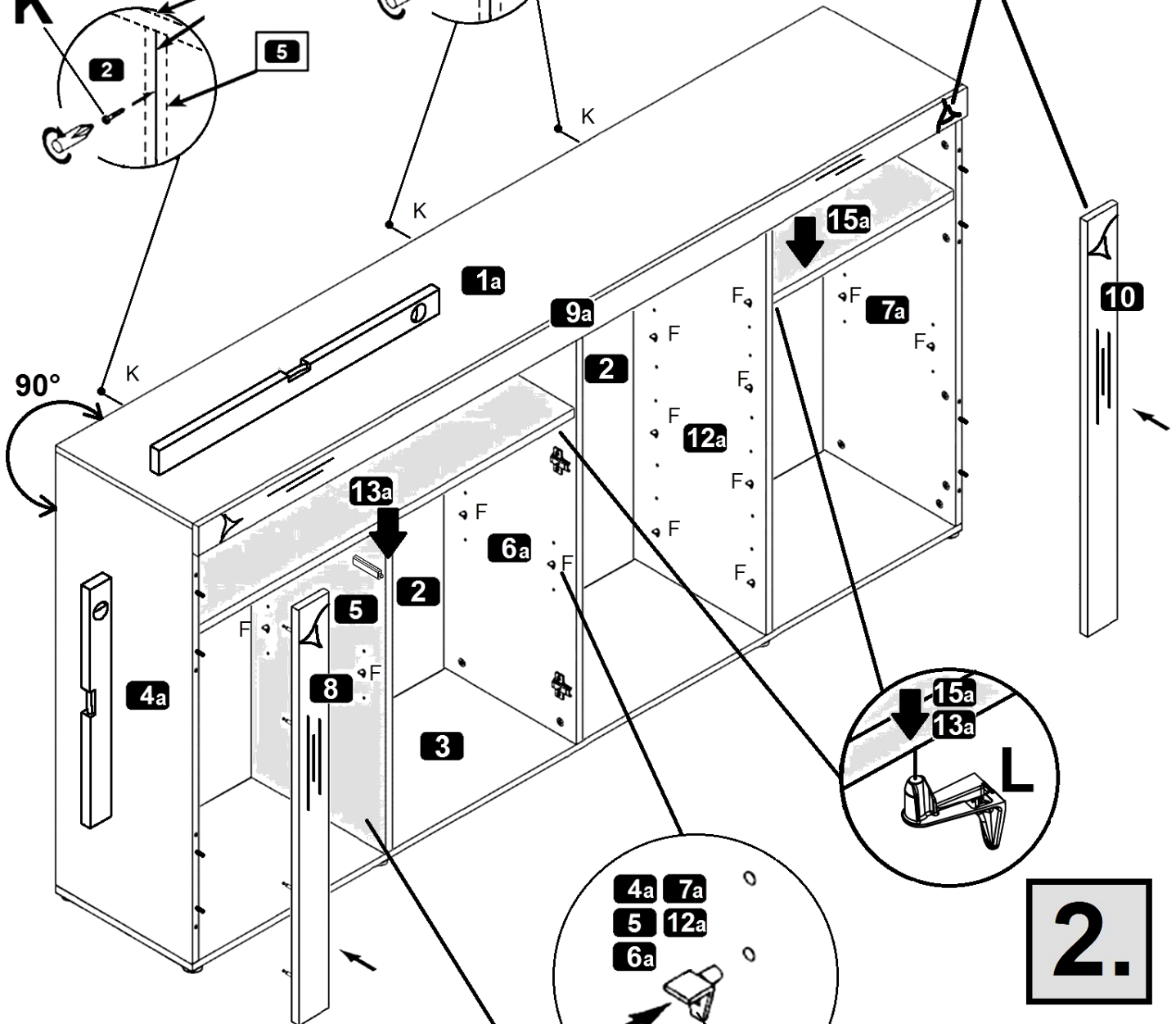
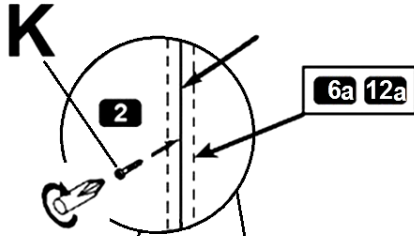
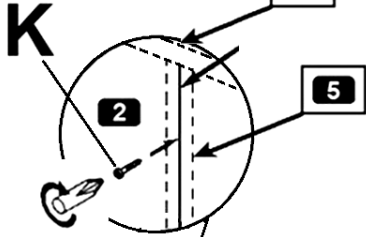

2.

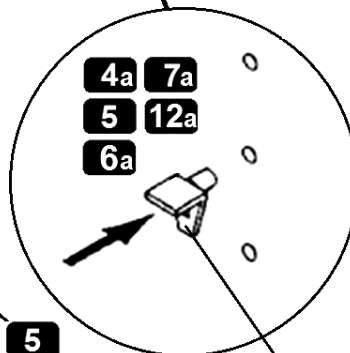
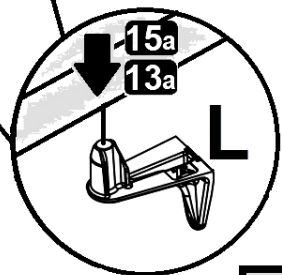

3.

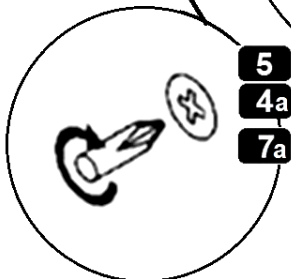

5.

F

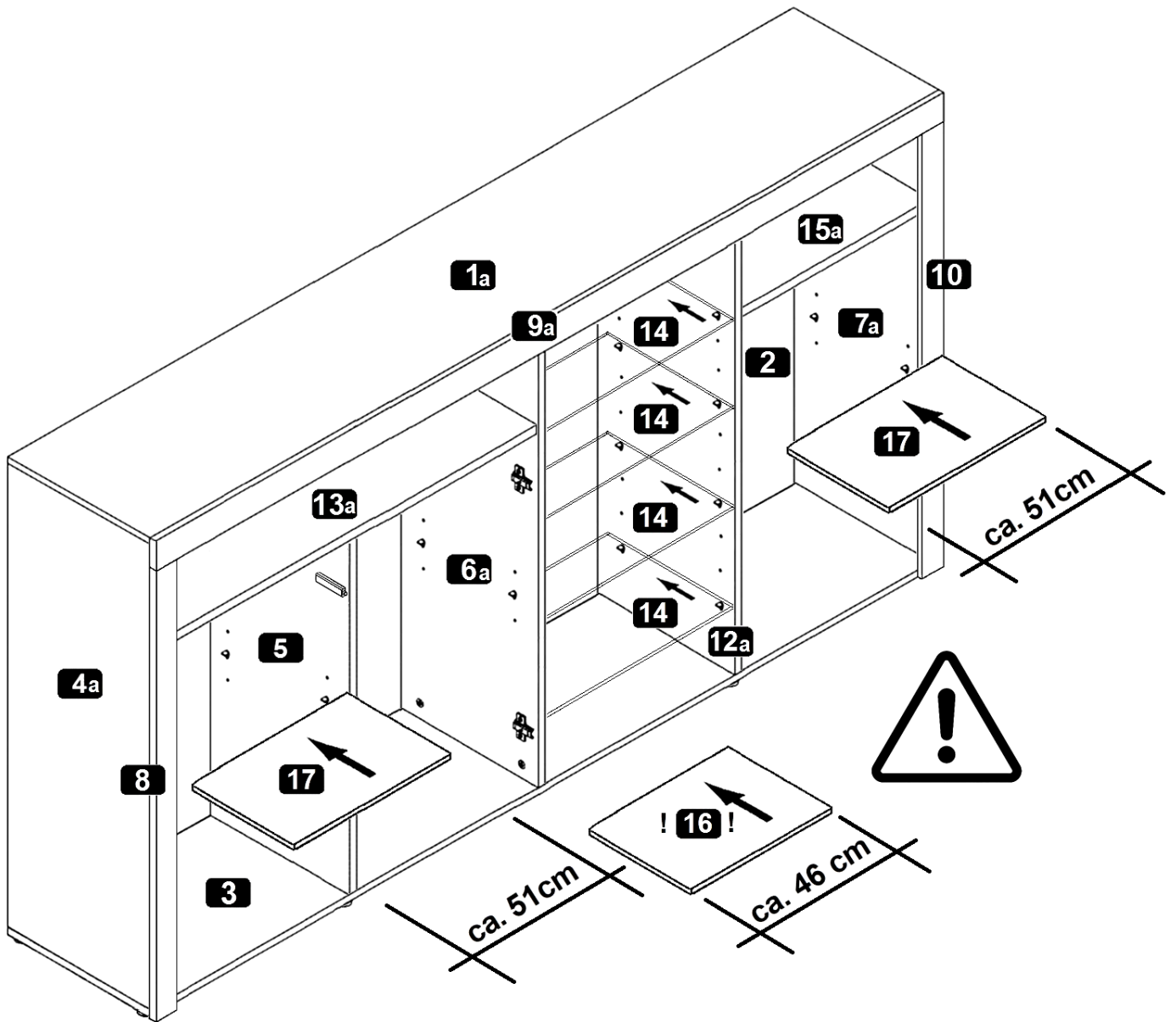

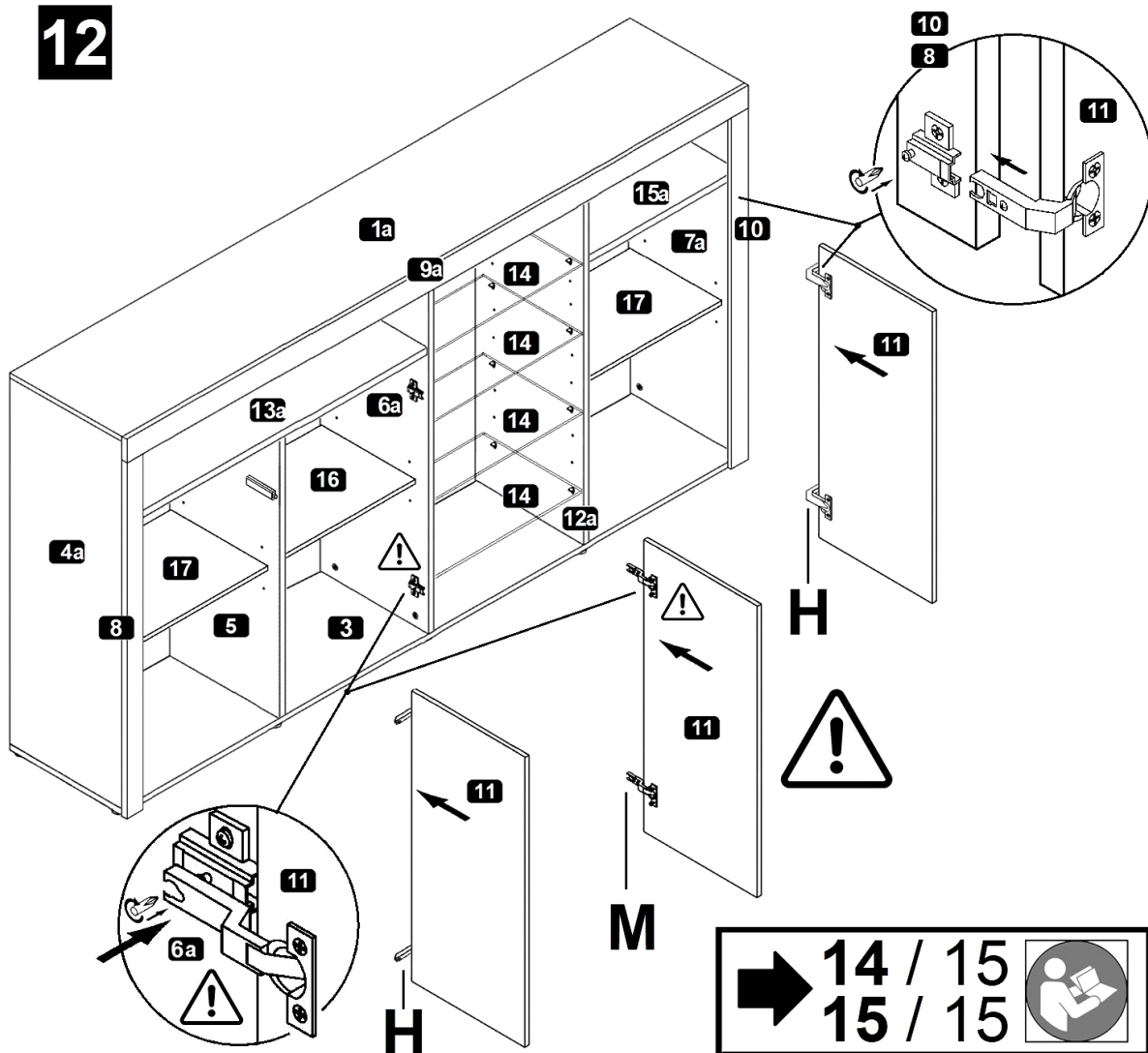

13 / 15	
<p>(D) Push-To-Open einstellen</p> <p>(GB) Adjusting the Push-To-Open</p> <p>(FR) Régler les Push-To-Open</p> <p>(IT) Sistemare Push-To-Open</p> <p>(NL) Push-To-Open instellen</p> <p>(PL) Nastawić Push-To-Open</p> <p>(CZ) Vyrovnajte dvířka (seřid'te závěsy)</p> <p>(RO) Nastavenie dverí (nastavenie závesov)</p> <p>(HU) Állítsa be az ajtókat (állítsa be a zsanérokot)</p> <p>(SK) Reglare uši (ajustare balamale)</p> <p>(TR) Push-To-Open ayarlanması</p> <p>(RU) Регулировка Push-To-Open</p>	

14 / 15	
<p>(D) Türen einstellen (Scharniere justieren)</p> <p>(GB) Adjusting the doors (adjusting the hinges)</p> <p>(FR) Régler les portes (ajuster les charnières)</p> <p>(IT) Sistemare le porte (regolare le cerniere)</p> <p>(NL) Deuren instellen (scharnieren afstellen)</p> <p>(PL) Nastawić drzwi (wyregulować zawiasy)</p> <p>(CZ) Vyrovnajte dvířka (seřid'te závěsy)</p> <p>(RO) Nastavenie dverí (nastavenie závesov)</p> <p>(HU) Állítsa be az ajtókat (állítsa be a zsanérokot)</p> <p>(SK) Reglare uši (ajustare balamale)</p> <p>(TR) Kapıların ayarlanması (mentşelerin seviye ayarı)</p> <p>(RU) Регулировка дверей (регулировка шарнира)</p>	

13

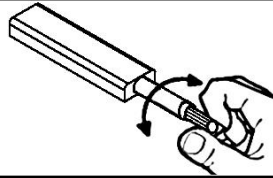

(D) Push-To-Open einstellen

(CZ) Vyrovnajte Push-To-Open

(GB) Adjusting the Push-To-Open

(RO) Nastavenie Push-To-Open

(FR) Régler les Push-To-Open

(HU) Állítsa be az Push-To-Open

(IT) Sistemare Push-To-Open

(SK) Reglare Push-To-Open

(NL) Push-To-Open instellen

(TR) Push-To-Open ayarlanması

(PL) Nastawić Push-To-Open

(RU) Регулировка Push-To-Open

1.

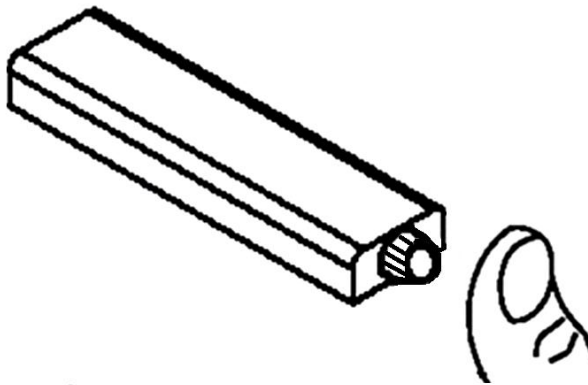

2.

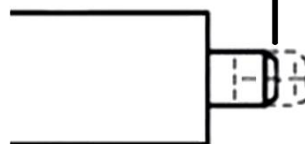
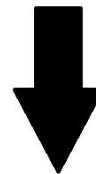
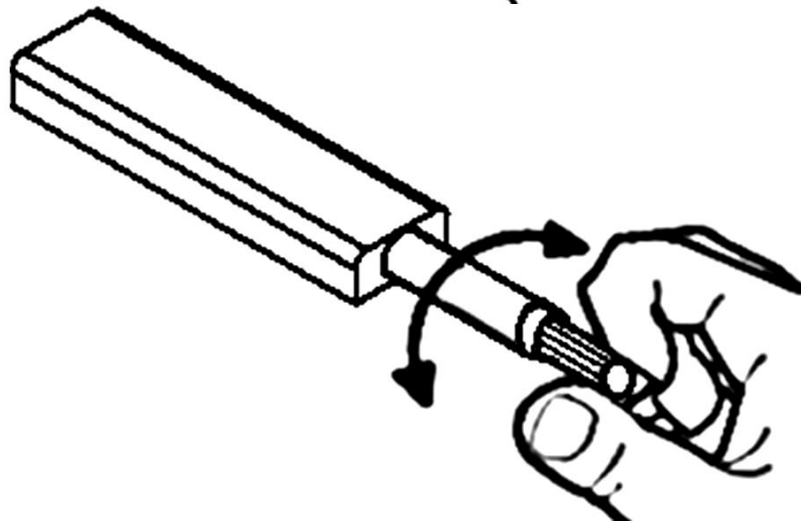

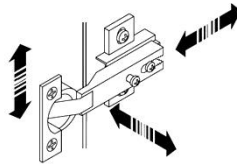

- | | |
|--|---|
| (D) Türen einstellen
(Scharniere justieren) | (CZ) Vyrovnajte dvířka
(seřid'te závěsy) |
| (GB) Adjusting the doors
(adjusting the hinges) | (RO) Nastavenie dverí
(nastavenie závesov) |
| (FR) Régler les portes
(ajuster les charnières) | (HU) Állítsa be az ajtókat
(állítsa be a zsanérokát) |
| (IT) Sistemare le porte
(regolare le cerniere) | (SK) Reglare uši
(ajustare balamale) |
| (NL) Deuren instellen
(scharnieren afstellen) | (TR) Kapıların ayarlanması
(menteşelerin seviye ayarı) |
| (PL) Nastawić drzwi
(wyregulować zawiasy) | (RU) Регулировка дверей
(регулировка шарнира) |

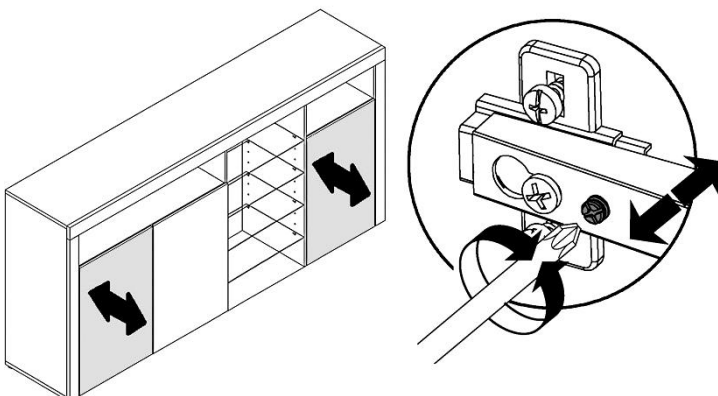
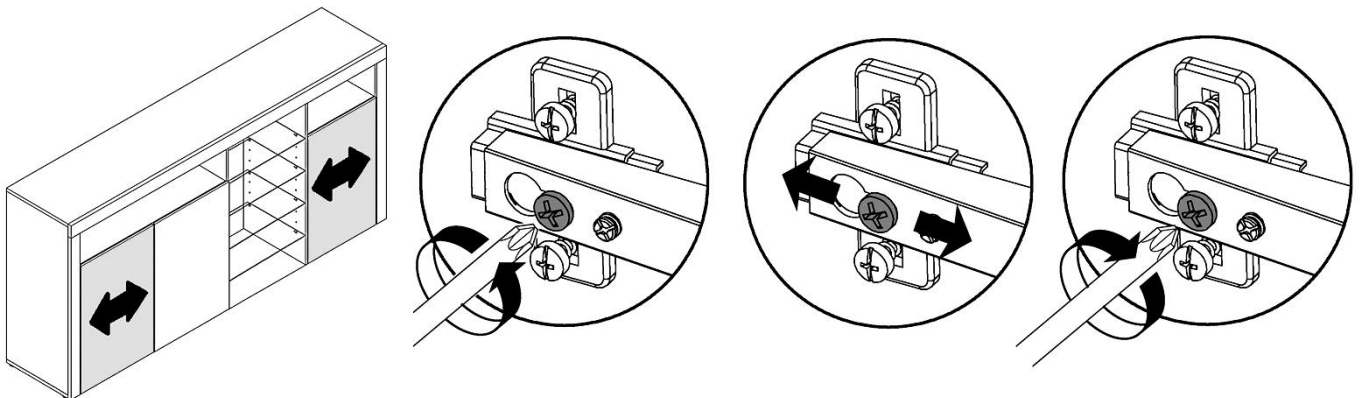
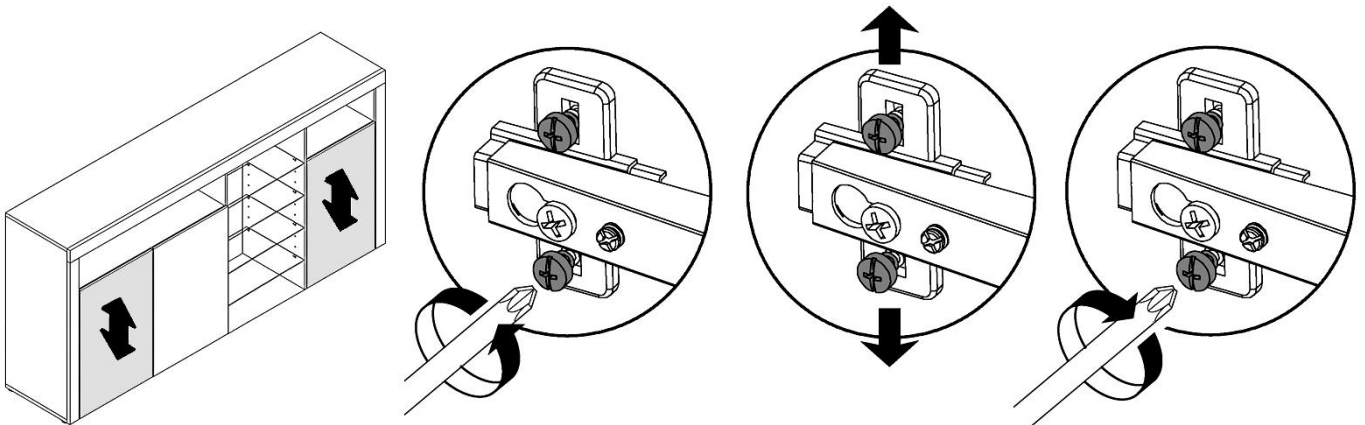

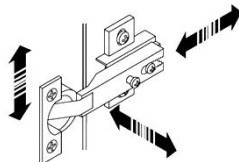

(D) Türen einstellen
(Scharniere justieren)

(GB) Adjusting the doors
(adjusting the hinges)

(FR) Régler les portes
(ajuster les charnières)

(IT) Sistemare le porte
(regolare le cerniere)

(NL) Deuren instellen
(scharnieren afstellen)

(PL) Nastawić drzwi
(wyregulować zawiasy)

(CZ) Vyrovnajte dvířka
(seřid'ťe závěsy)

(RO) Nastavenie dverí
(nastavenie závesov)

(HU) Állítsa be az ajtókat
(állítsa be a zsanérokat)

(SK) Reglare uši
(ajustare balamale)

(TR) Kapıların ayarlanması
(mentşelerin seviye ayarı)

(RU) Регулировка дверей
(регулировка шарнира)

