

**(D)** Montageanleitung

**(GB)** Assembly instructions

**(FR)** Notice de montage

**(IT)** Istruzioni di montaggio

**(NL)** Handleiding voor de montage

**(PL)** Instrukcja montażu

**(CZ)** Montážní návod

**(SK)** Návod na montáž

**(HU)** Szerelési útmutató

**(RO)** Instrucțiuni de montaj

**(TR)** Montaj talimatı

**(RU)** Инструкция по монтажу



Ausgabe:20130830

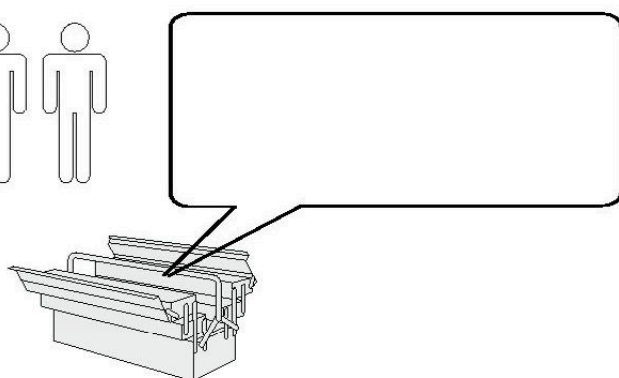
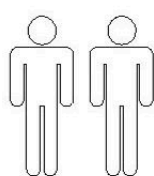

**Service • Assistenza • Dienstverlening • Serwis  
Servis • Szerviz • Сервисная служба**

Name • Nom • Nome • Naam  
Nazwa • Jméno • Názov •  
Név  
Denumire • Isim • Название

**DIANA**

Nr. • No. • N° • Номер • Č •  
Sz

**4726 2563**

**3952 9959**

Typ • Type • Tip • Típus •

Tipo

Тип

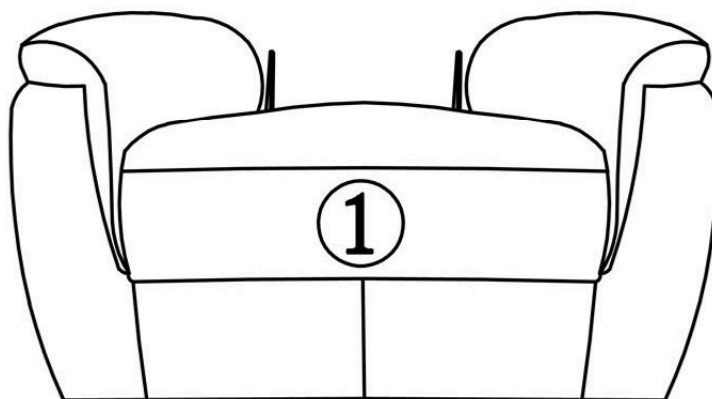
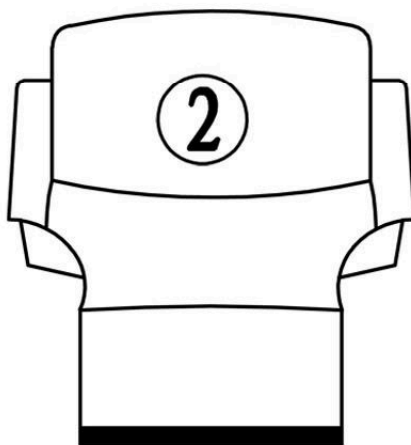
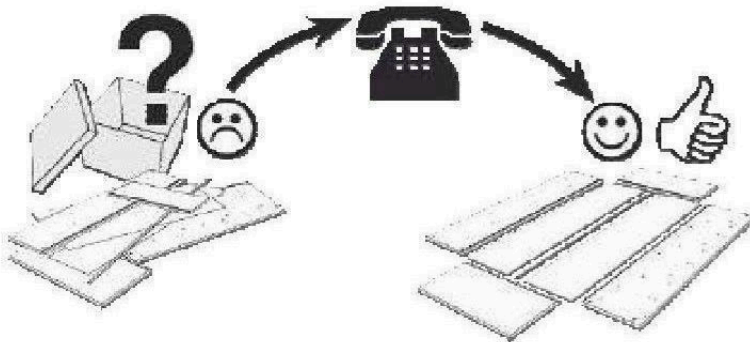
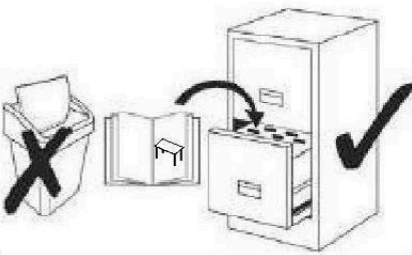

1

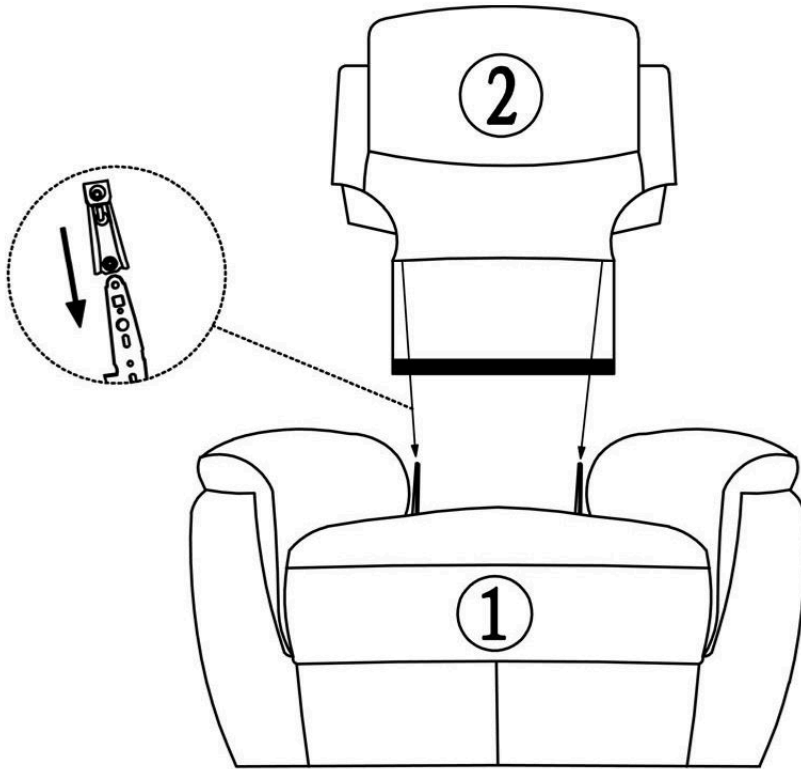

2



