

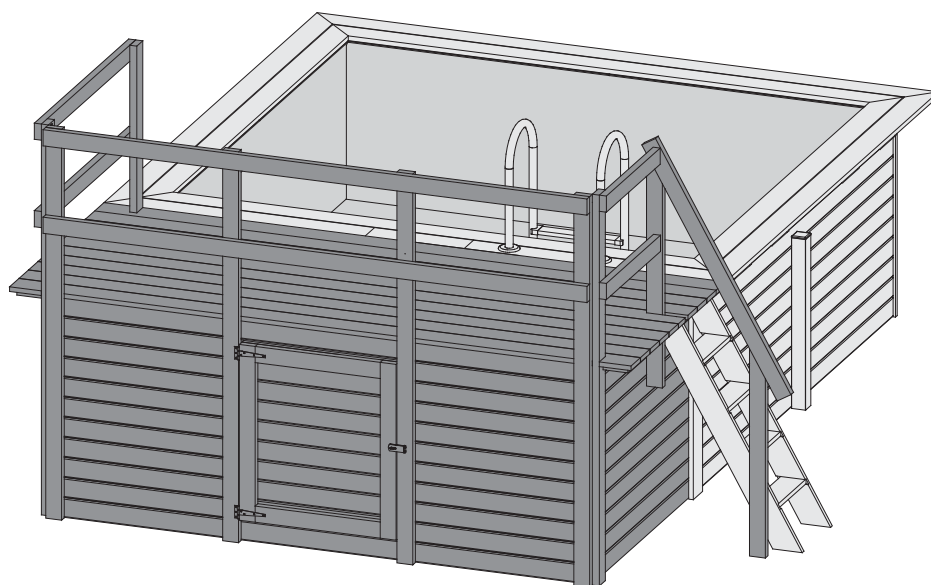

19748

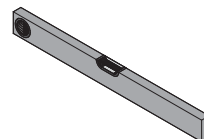

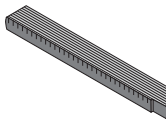
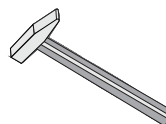
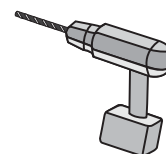
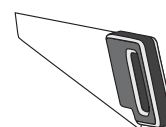

-  **Aufbauanleitung**
-  **Building Instructions**
-  **notice de montage**
-  **montagehandleiding**
-  **Montagevejledning**
-  **Instrucciones de construcción**
-  **Istruzioni per il montaggio**
-  **Montážní návod**





 Vergleichen Sie zuerst die Material-liste mit Ihrem Paketinhalt! Bitte haben Sie Verständnis, dass Beanstandungen nur im nicht aufgebauten Zustand bearbeitet werden können!

 Vergelijk eerst de lijst van materialen met de inhoud van uw pakket! Reclamaties kunnen alleen in behandeling worden genomen zolang de onderdelen nog niet zijn gemonteerd!

 Confrontate questa distinta materiali prima con il contenuto del pacchetto! Vi preghiamo di comprendere che eventuali reclami possono essere accolti solo prima del montaggio!

 First compare the list of materials with your package contents! Please understand that complaints can be processed in the non-built status only!

 Start med at kontrollere materialelisten med indholdet af den leverede pakke! Vi gør venligst opmærksom på at reklamationer kun kan behandles for materialer som ikke er blevet bearbejdet!

 Nejprve překontrolujte obsah balení podle materiálového listu! Mějte pochopení pro to, že případnou reklamaci se můžeme zabývat pouze tehdy, když díly nebudou smontované! Za pomoci tohoto seznamu můžete jednotlivé díly přidat k montážnímu návodu.

 Commencez par comparer la liste du matériel avec le contenu de votre paquet! Sachez que nous traitons uniquement les réclamations concernant le matériel à l'état non monté!

 En primer lugar, compare la lista de material con el contenido del paquete. Rogamos entienda que las reclamaciones sólo pueden ser tramitadas antes de montar el objeto!

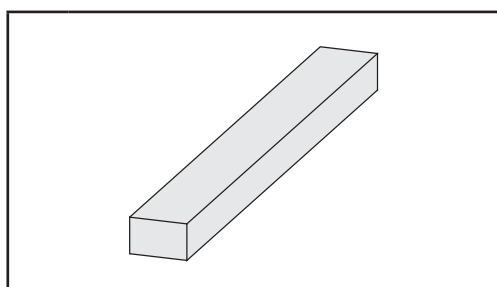
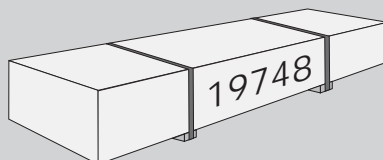

11 x B1	3528 x 140 x 26 mm	ID 31210
1 x B2	386 x 58 x 28 mm	ID 25881
6 x B3	322 x 90 x 40 mm	ID 25857
2 x B4	808 x 90 x 40 mm	ID 25299
2 x B5	1092 x 90 x 40 mm	ID 34272
2 x B6	1155 x 90 x 40 mm	ID 39906
6 x B7	1222 x 90 x 40 mm	ID 25856
9 x B8	1570 x 90 x 40 mm	ID 25296
7 x B9	2177 x 90 x 40 mm	ID 25297
2 x B10	2852 x 90 x 40 mm	ID 25298
2 x B11	3087 x 90 x 40 mm	ID 25300

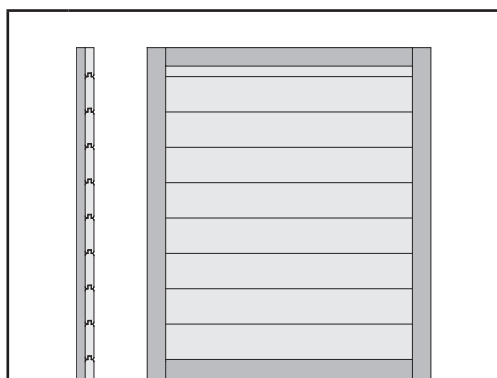

1 x D1	980 x 890 x 28 mm	ID 25834
--------	-------------------	----------

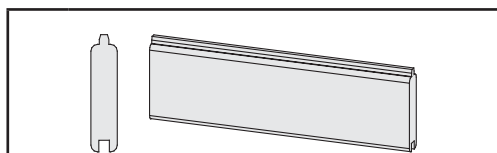

18 x W1	1066 x 121 x 28 mm	ID 25292
20 x W2	1490 x 121 x 28 mm	ID 25269
1 x W3	3032 x 121 x 28 mm	ID 25293

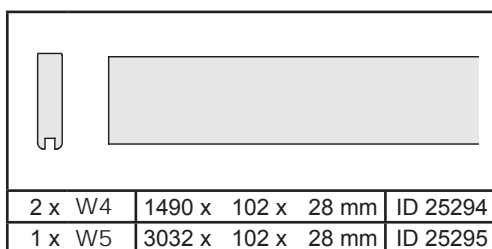

2 x W4	1490 x 102 x 28 mm	ID 25294
1 x W5	3032 x 102 x 28 mm	ID 25295

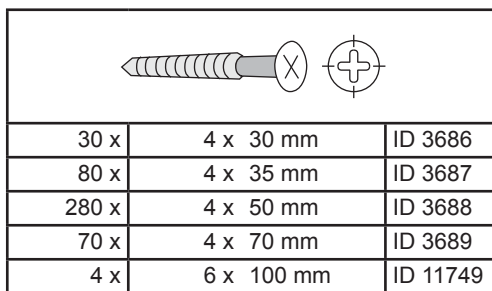

30 x	4 x 30 mm	ID 3686
80 x	4 x 35 mm	ID 3687
280 x	4 x 50 mm	ID 3688
70 x	4 x 70 mm	ID 3689
4 x	6 x 100 mm	ID 11749

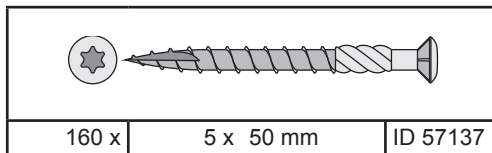

160 x	5 x 50 mm	ID 57137
-------	-----------	----------

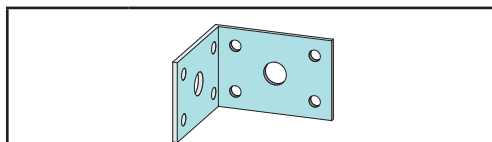

3 x	ID 21292
-----	----------

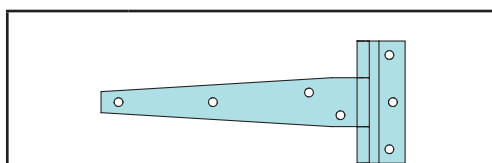

2 x	ID 3716
-----	---------

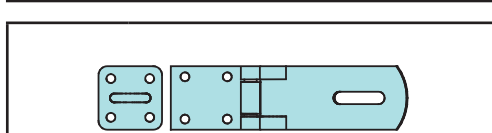

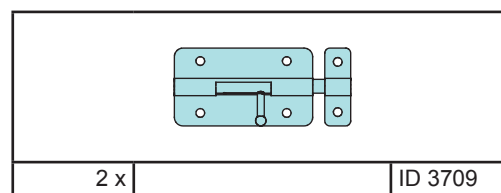

1 x	ID 3724
-----	---------





2 x	ID 3709
-----	---------

 Um das Ertrinken von Kindern zu verhindern, wird empfohlen, den Zugang zum Schwimmbecken mit einer Schutzvorrichtung zu sichern!

 For at forhindre drukning af børn anbefales det at sikre adgang til swimmingpoolen med en beskyttelsesanordning!

 To prevent the drowning of children, it is recommended to secure access to the swimming pool with a protective device!

 Para evitar que los niños se ahoguen, se recomienda asegurar el acceso a la piscina con un dispositivo de protección.





 Pour éviter la noyade des enfants, il est recommandé de sécuriser l'accès à la piscine avec un dispositif de protection!





 Per prevenire l'annegamento dei bambini, si consiglia di proteggere l'accesso alla piscina con un dispositivo di protezione!





 Om verdrinking van kinderen te voorkomen, is het aan te raden om de toegang tot het zwembad te beveiligen met een beschermend apparaat!





 Aby se zabránilo utopení dětí, doporučuje se zajistit přístup k bazénu s ochranným zařízením!



- *  Nicht im Lieferumfang enthalten
-  Not included
-  Non comprises dans la livraison
-  Niet bijgeleverd

-  No forman parte del suministro
-  Non incluso
-  V ceně není zahrnuto
-  Ikke inkluderet

- 1
-  Länge muss ermittelt und zugesägt werden
 -  Length must be determined and sawn
 -  La longueur doit être déterminée et sciée
 -  De lengte moet worden bepaald en worden gezaagd

-  La longitud debe ser determinada y aserrada
-  La lunghezza deve essere determinata e segata
-  Délka musí být určena a rozřezána
-  Længden skal bestemmes og saves

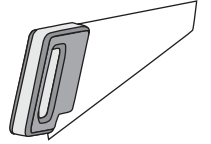
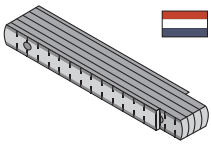



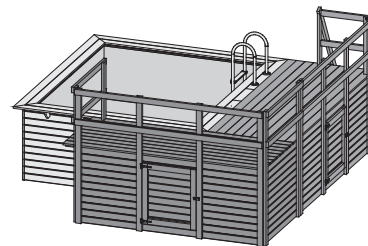

- 2
-  Nicht gebraucht
 -  Not needed
 -  Pas nécessaire
 -  Niet nodig

-  No es necesario
-  Non necessario
-  Není nutná

3





- 4
-  Fixiert vorübergehend
 -  tijdelijk vast
 -  Fixed temporarily
 -  temporairement fixe

-  temporalmente fijo
-  temporaneamente fisso
-  dočasně pevný
-  Zčasno pritrjeno

 Vorbereitung
 preparation
 préparation

 voorbereiding
 forberedelse
 preparación

 preparazione
 příprava

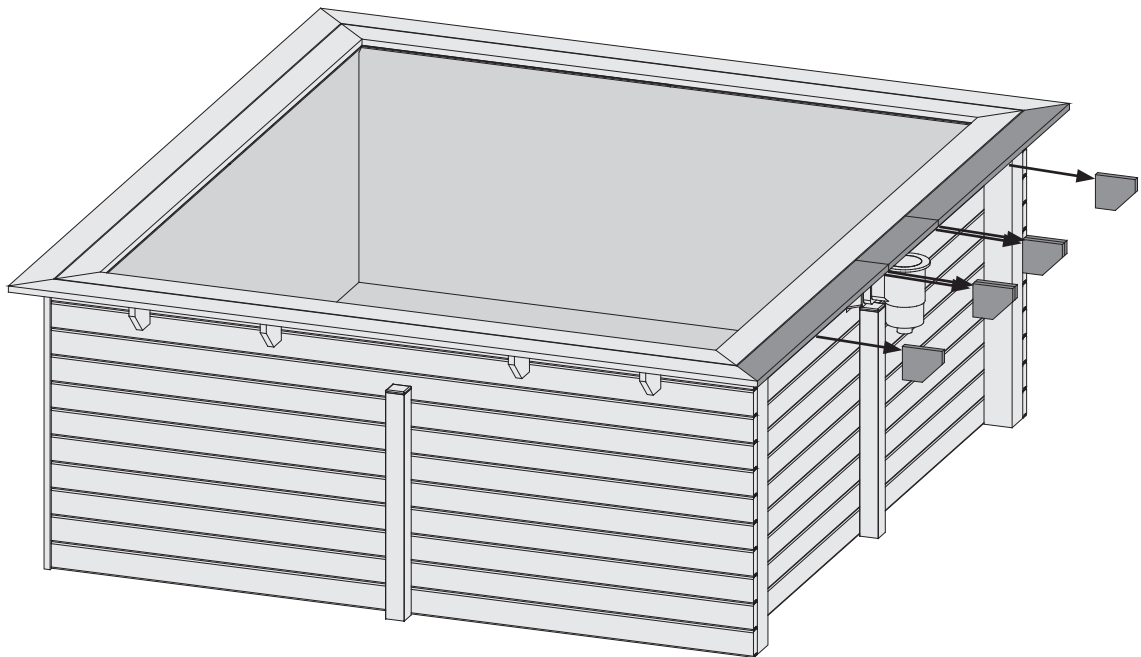
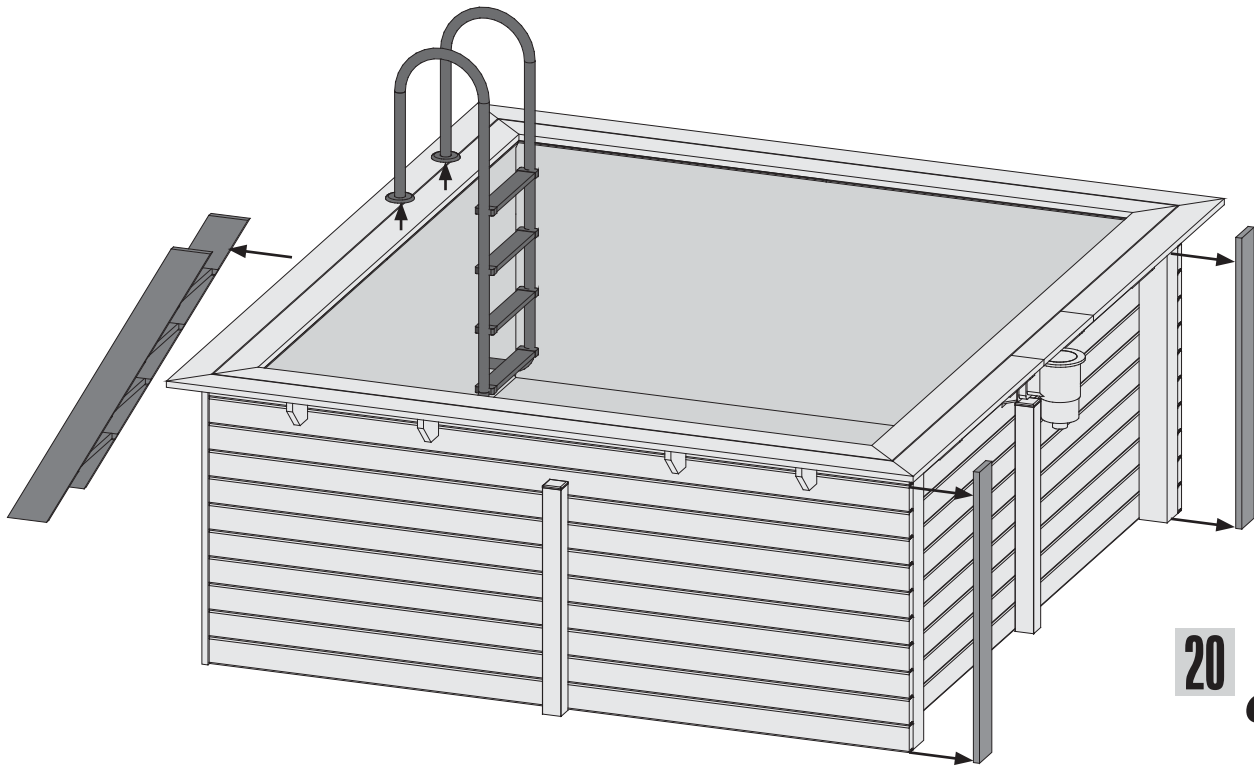

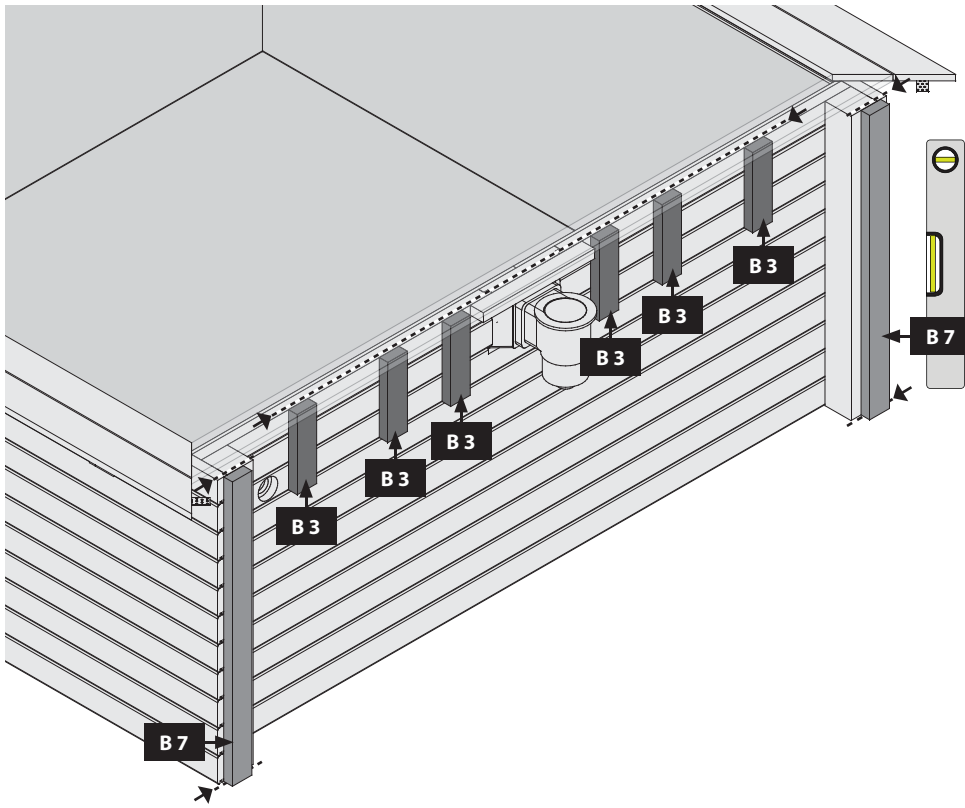

Ø3 mm 4x50

24x

Ø3 mm 4x70

16x

-  Bündig!
-  Flush!
-  Affleurement!
-  Gelijk!
-  I flugt!
-  Aras!
-  Combacia!
-  Stejný !

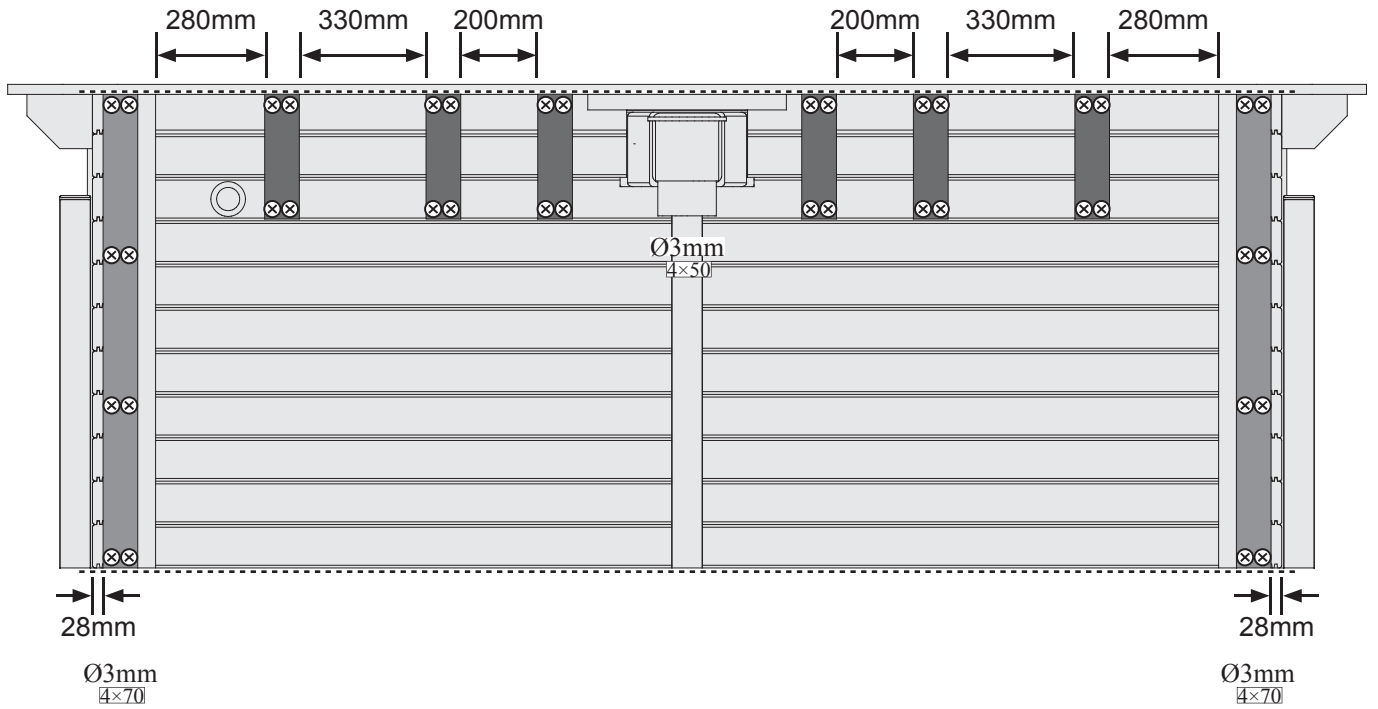

Ø3 mm 4x50
24x

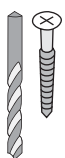
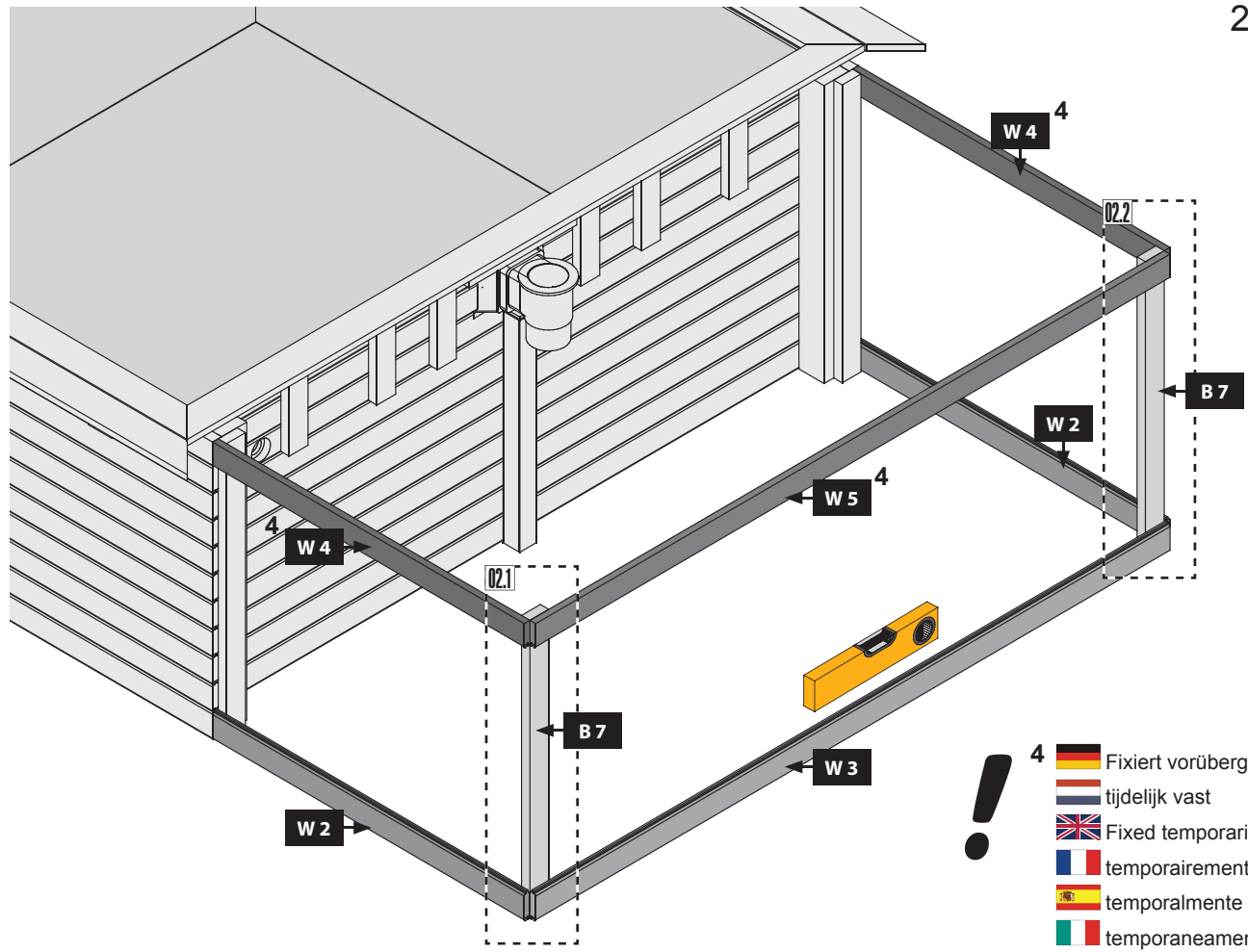
- ! 4
-  Fixiert vorübergehend
 -  tijdelijk vast
 -  Fixed temporarily
 -  temporairement fixe
 -  temporalmente fijo
 -  temporaneamente fissa
 -  dočasně pevný
 -  Začasno pritrjeno

02.1



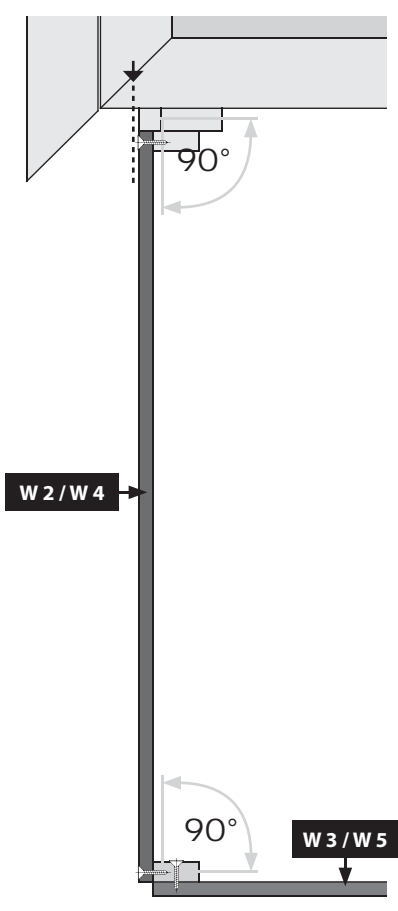



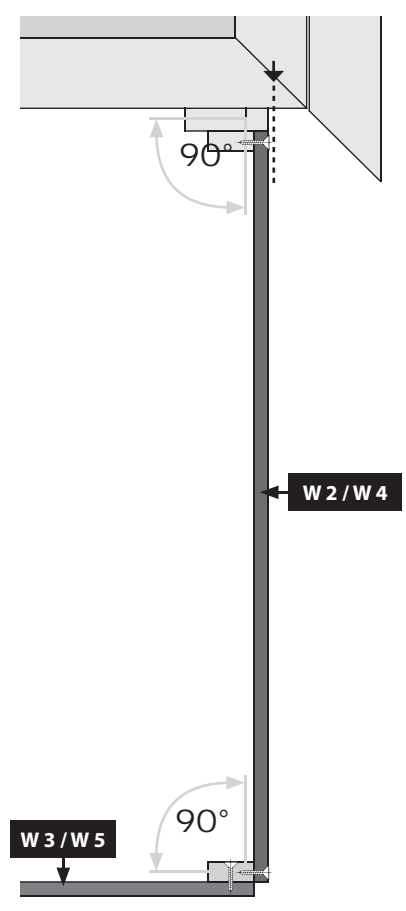

-  Bündig!
-  Flush!
-  Affleurement!
-  Gelijk!
-  I flugt!
-  Aras!
-  Combacia!
-  Stejný !



-  Draufsicht
-  Top view
-  vue de dessus
-  bovenaanzicht
-  vista desde arriba
-  vista desde arriba
-  vista dall'alto
-  půdorys

02.2



 Achten Sie auf die gleiche Höhe
 Look for the same height
 Faites attention à la même hauteur

 Besteed aandacht aan de dezelfde hoogte
 Prestar atención a la misma altura
 Prestare attenzione alla stessa altezza

 Dávejte pozor na stejnou výšku
 Pazite na enako višino

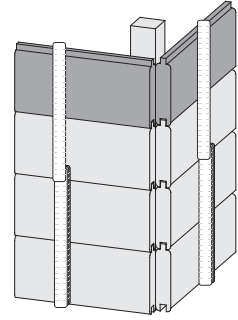
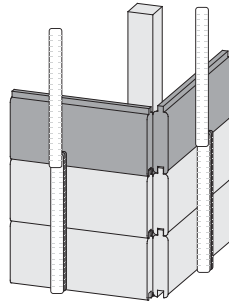
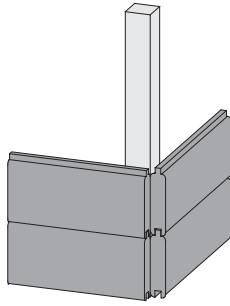
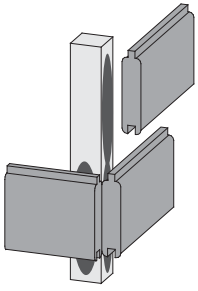

03

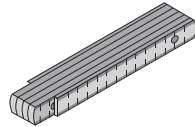

Ø3 mm  4x50

96x 

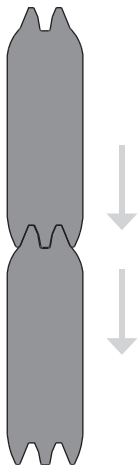
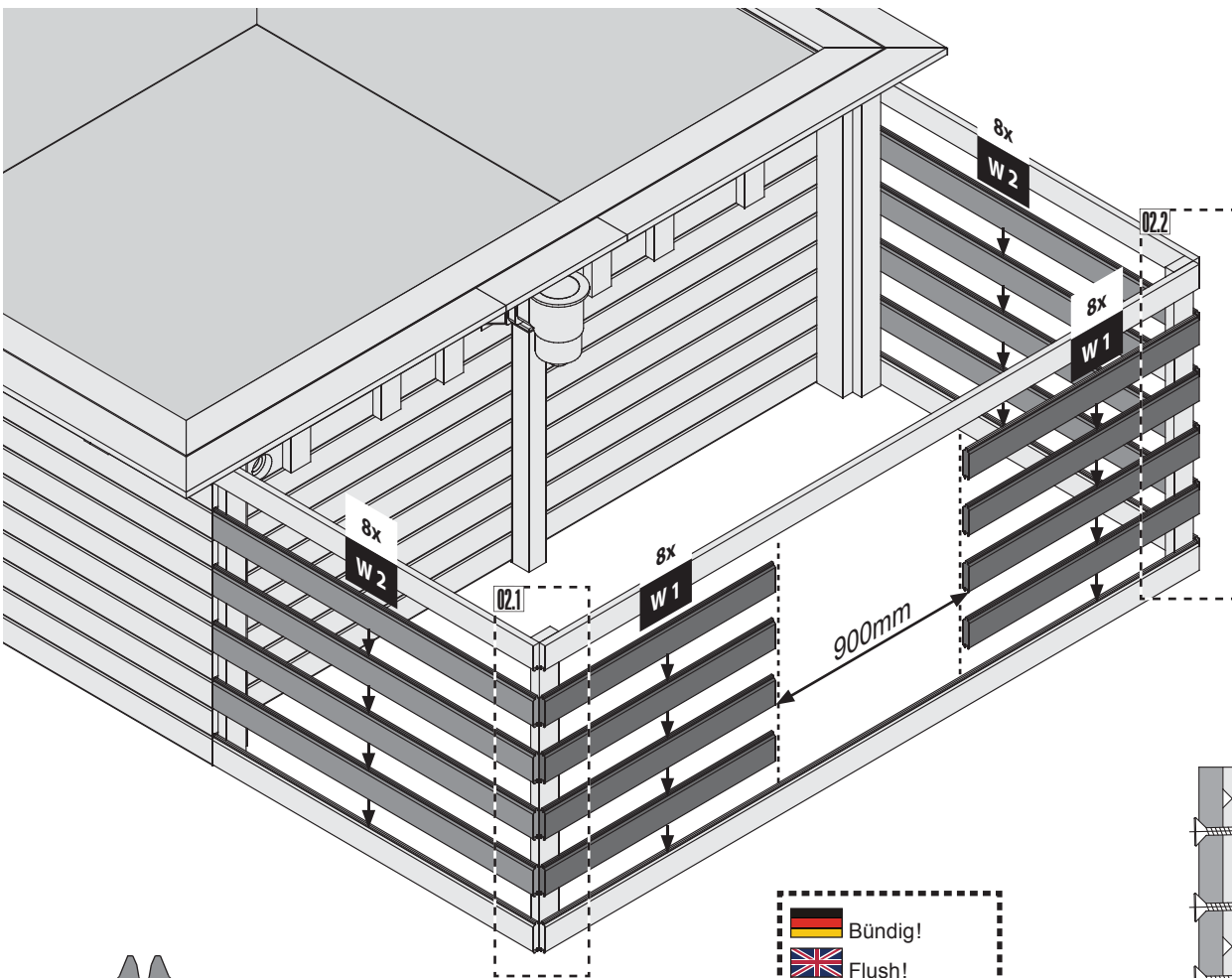

-  Bündig!
-  Flush!
-  Affleurement!
-  Gelijk!
-  I flugt!
-  Aras!
-  Combacia!
-  Stejný !

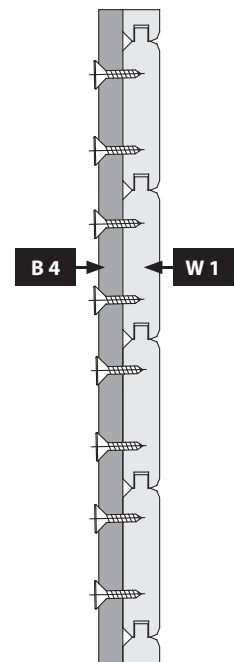

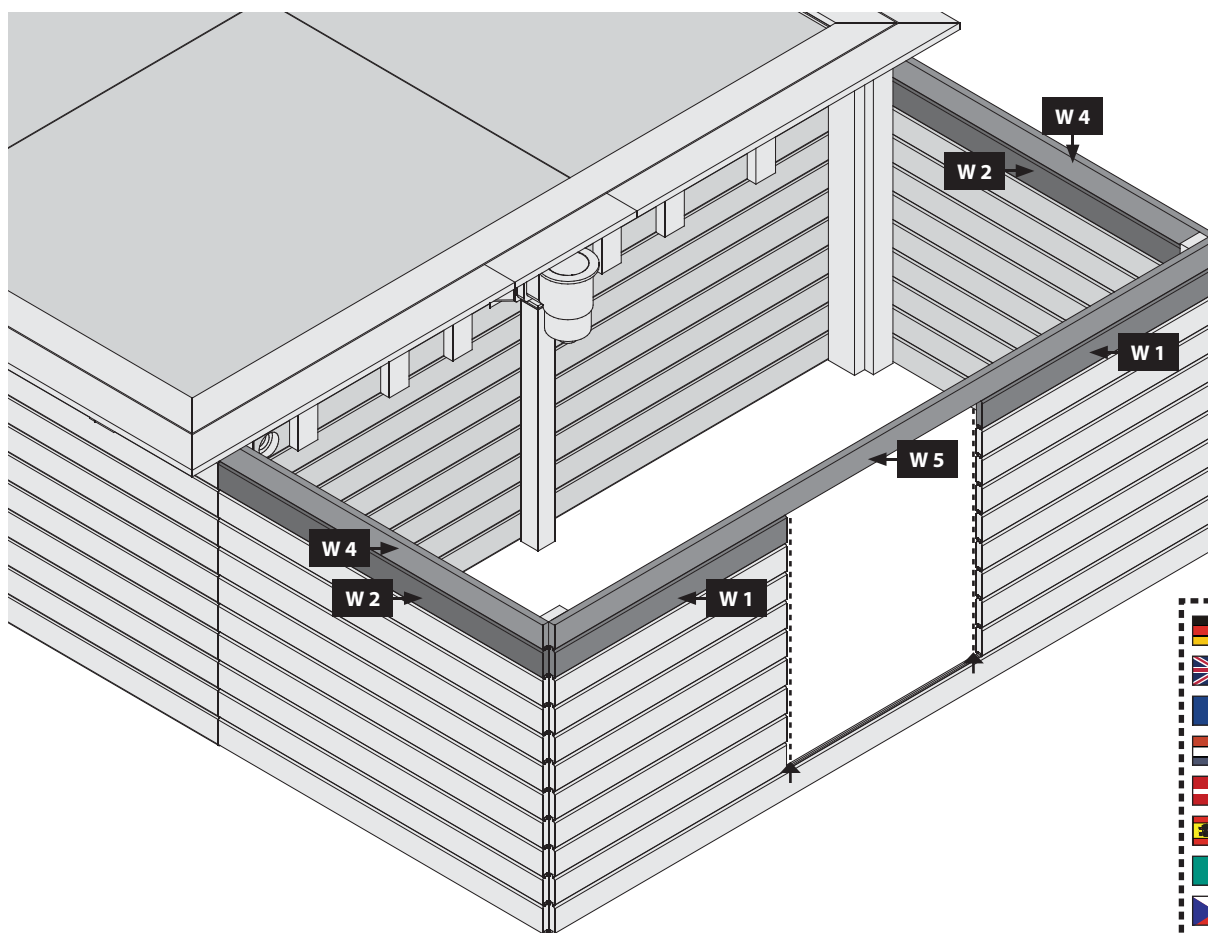
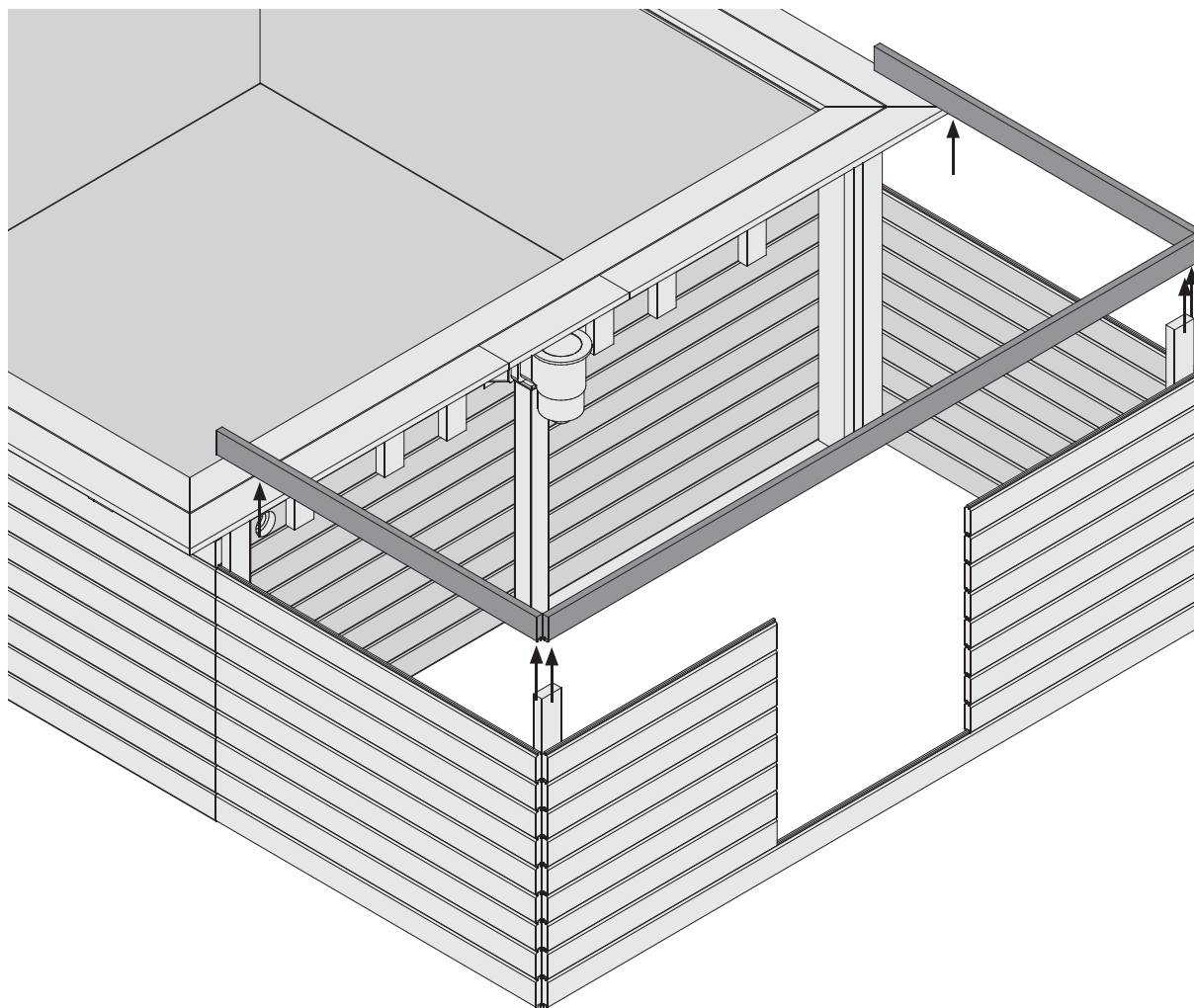

Ø3 mm 4x50
24x

-  Bündig!
-  Flush!
-  Affleurement!
-  Gelijk!
-  I flugt!
-  Aras!
-  Combacia!
-  Stejný !

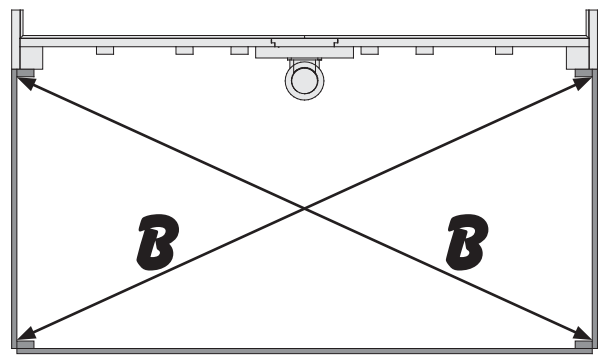
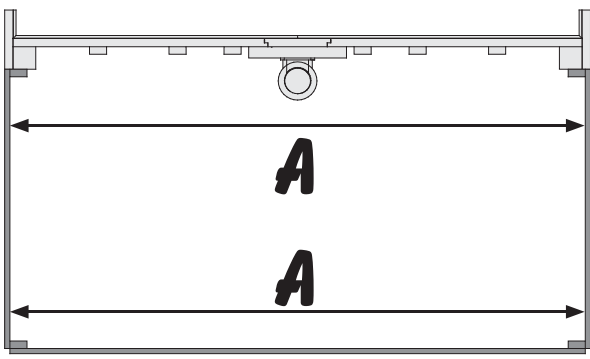

06

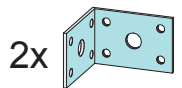
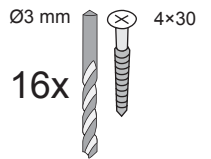
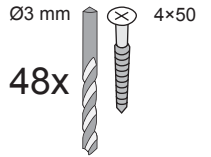
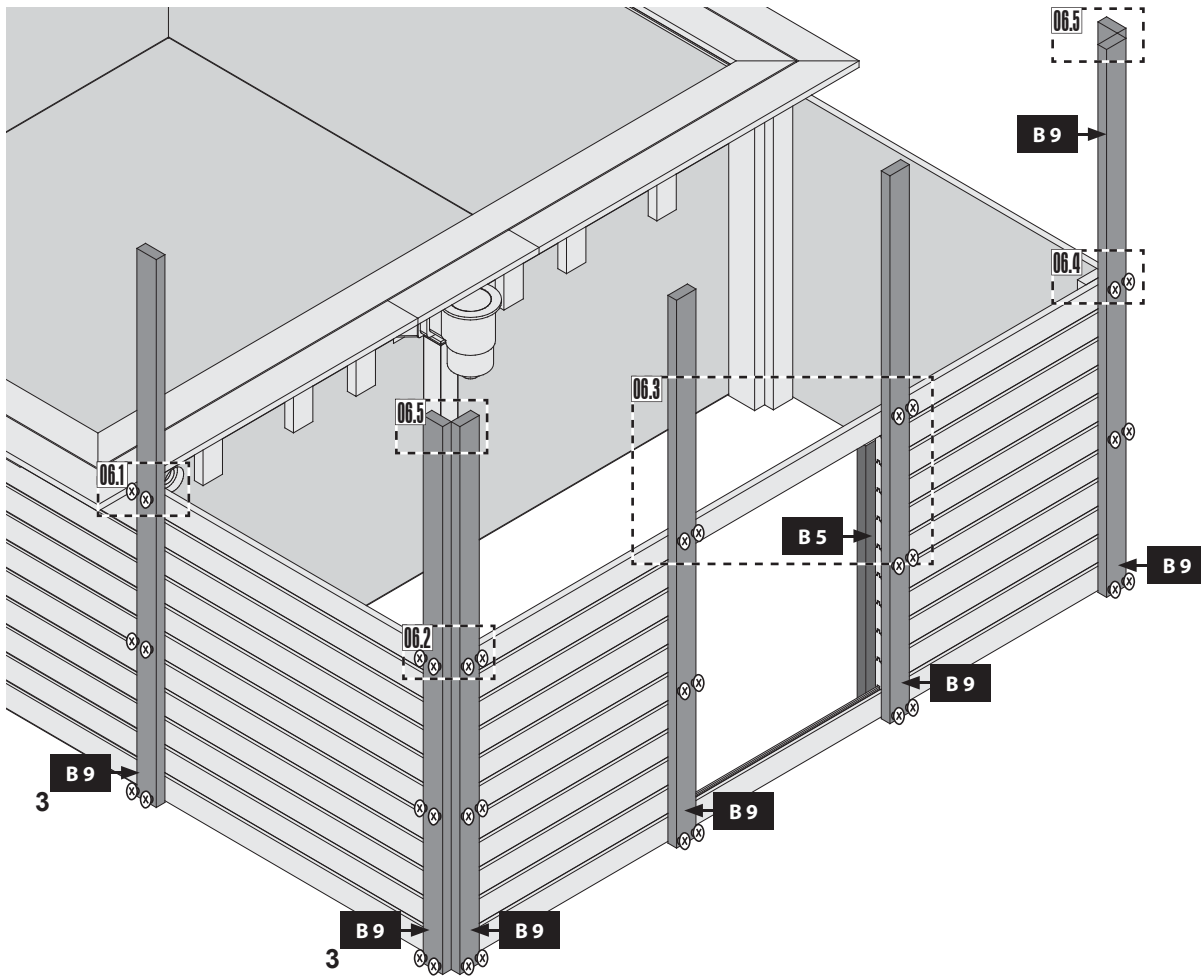

- Bündig!
- Flush!
- Affleurement!
- Gelijk!
- I flugt!
- Aras!
- Combacia!
- Stejný !

06.1

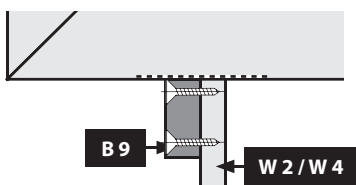

06.5

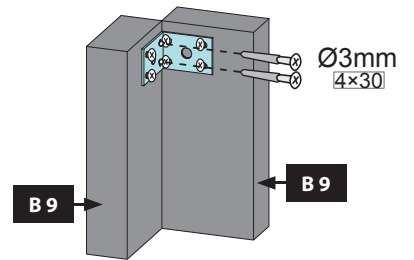

06.2

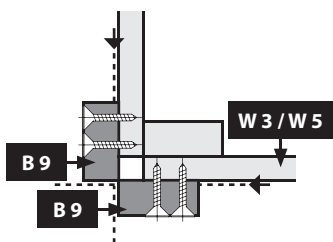

06.3

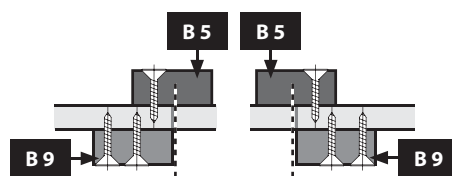

06.4

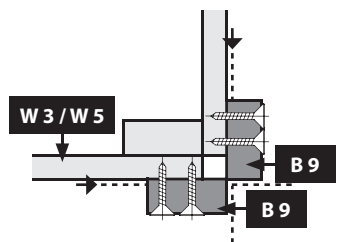

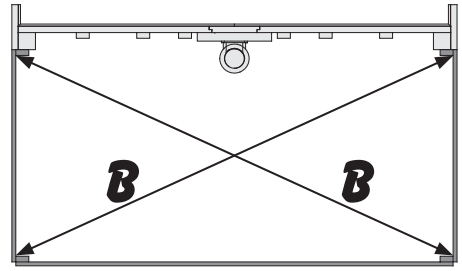
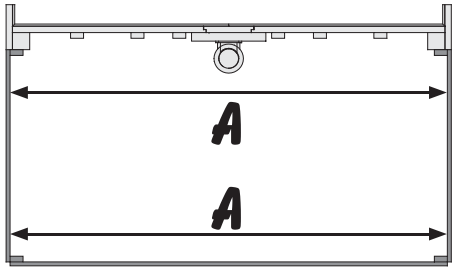
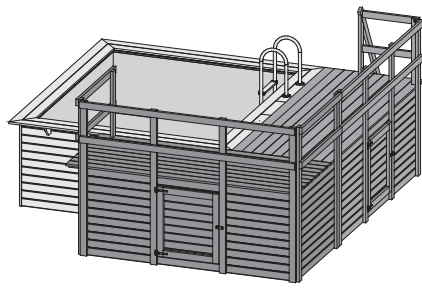
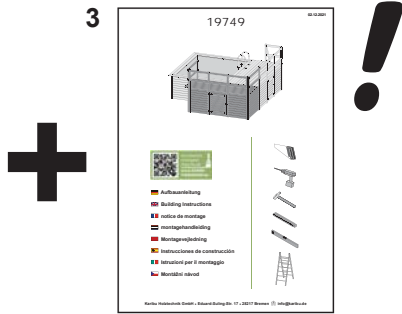

06

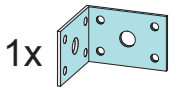
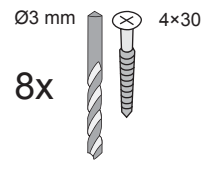
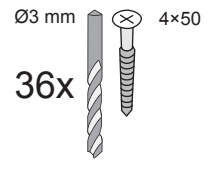
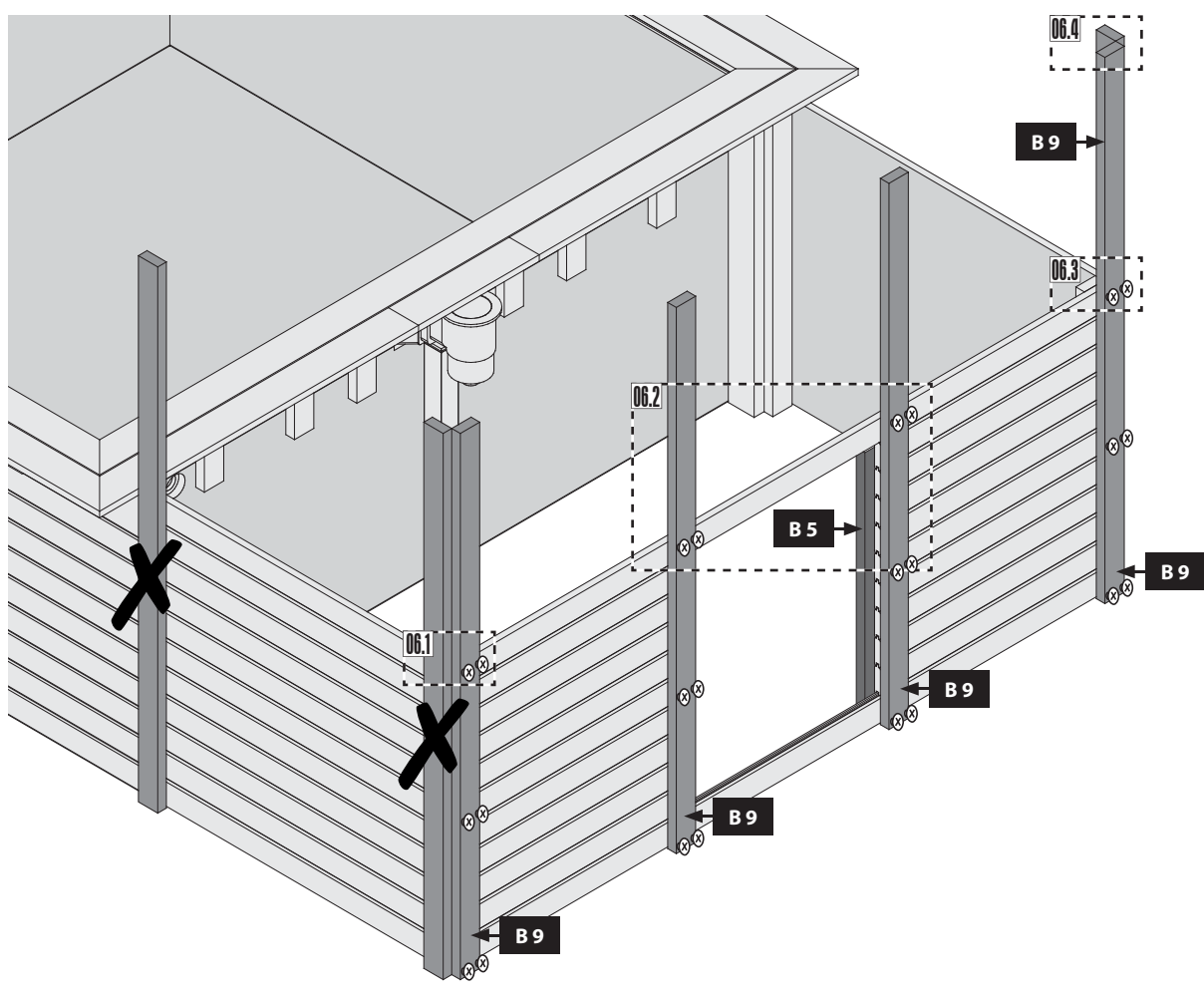

- Bündig!
- Flush!
- Affleurement!
- Gelijk!
- I flugt!
- Aras!
- Combacia!
- Stejný !

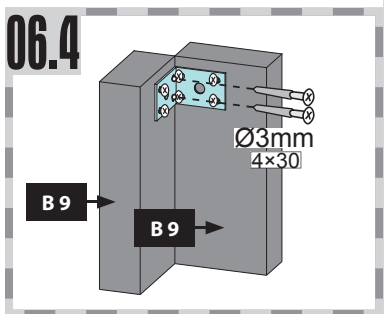
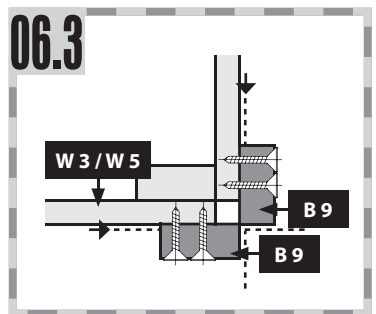
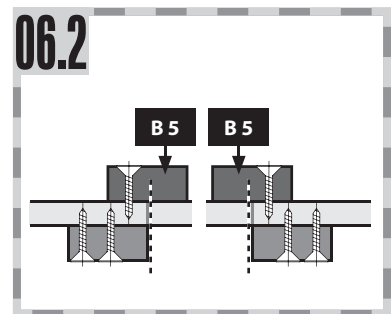
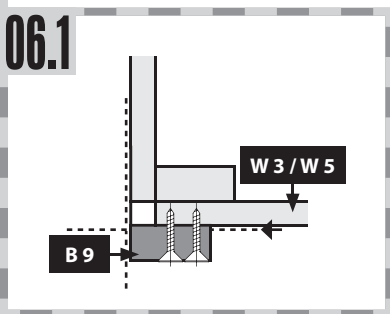

07

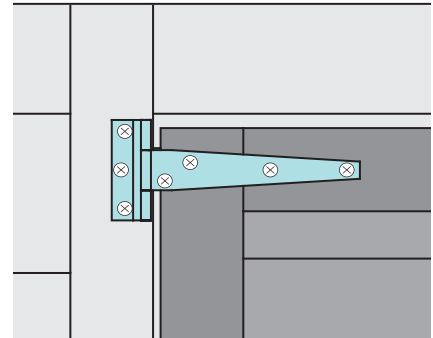
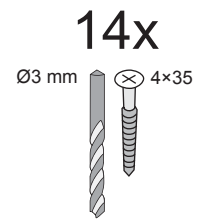
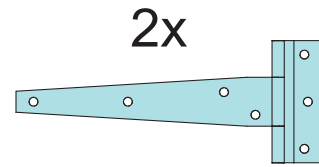
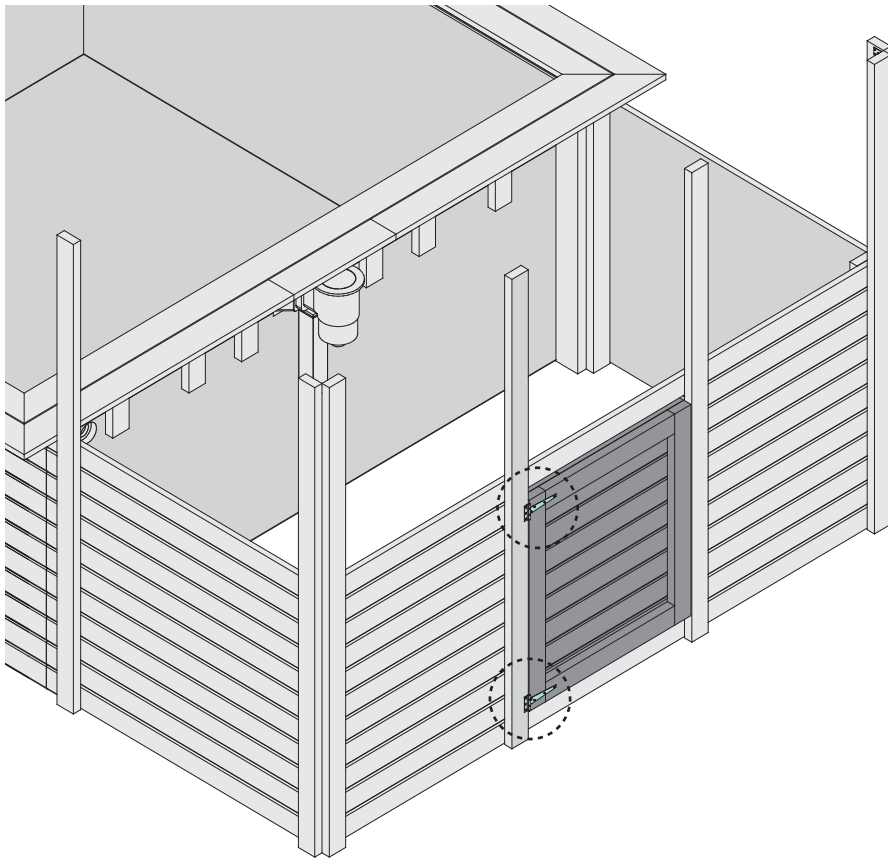

08

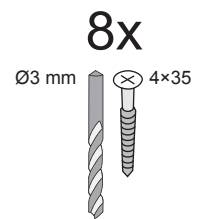
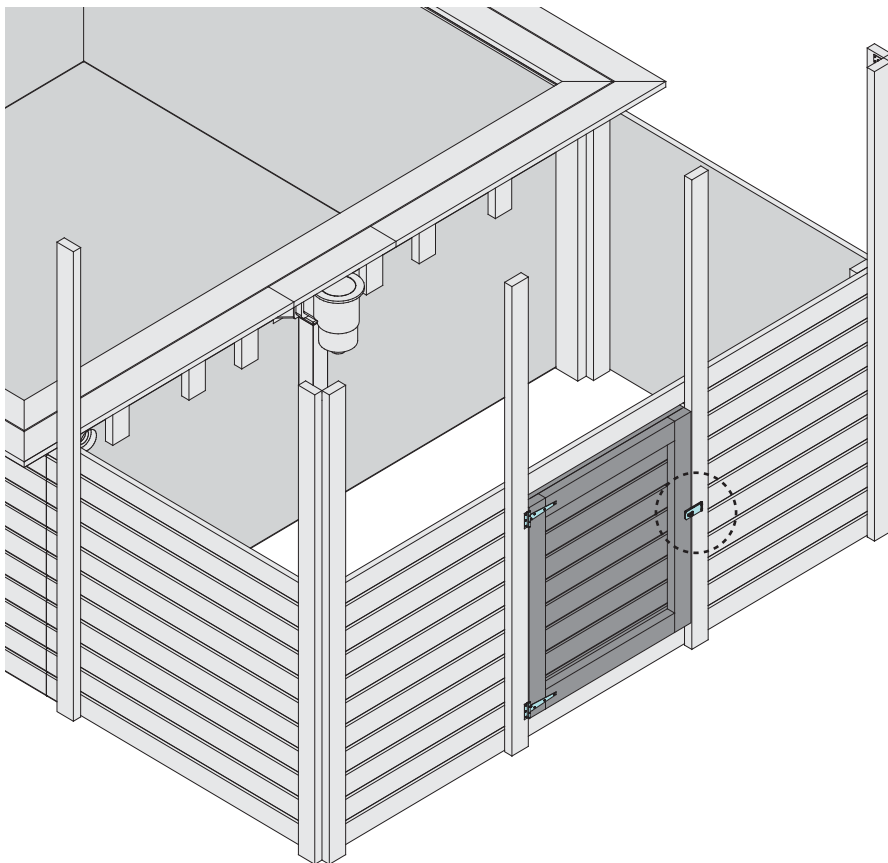

- 1.
- 2.
- 3.

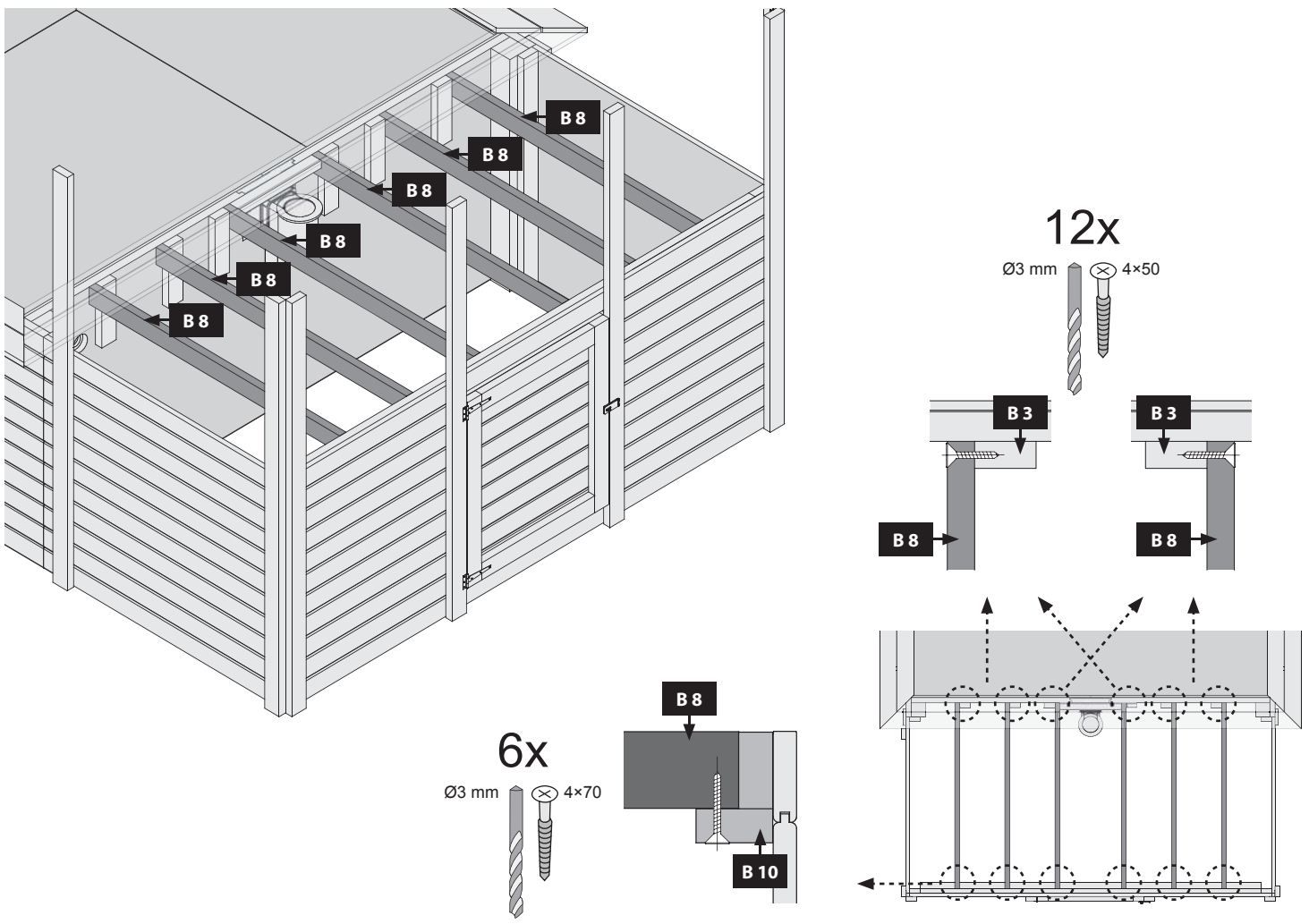
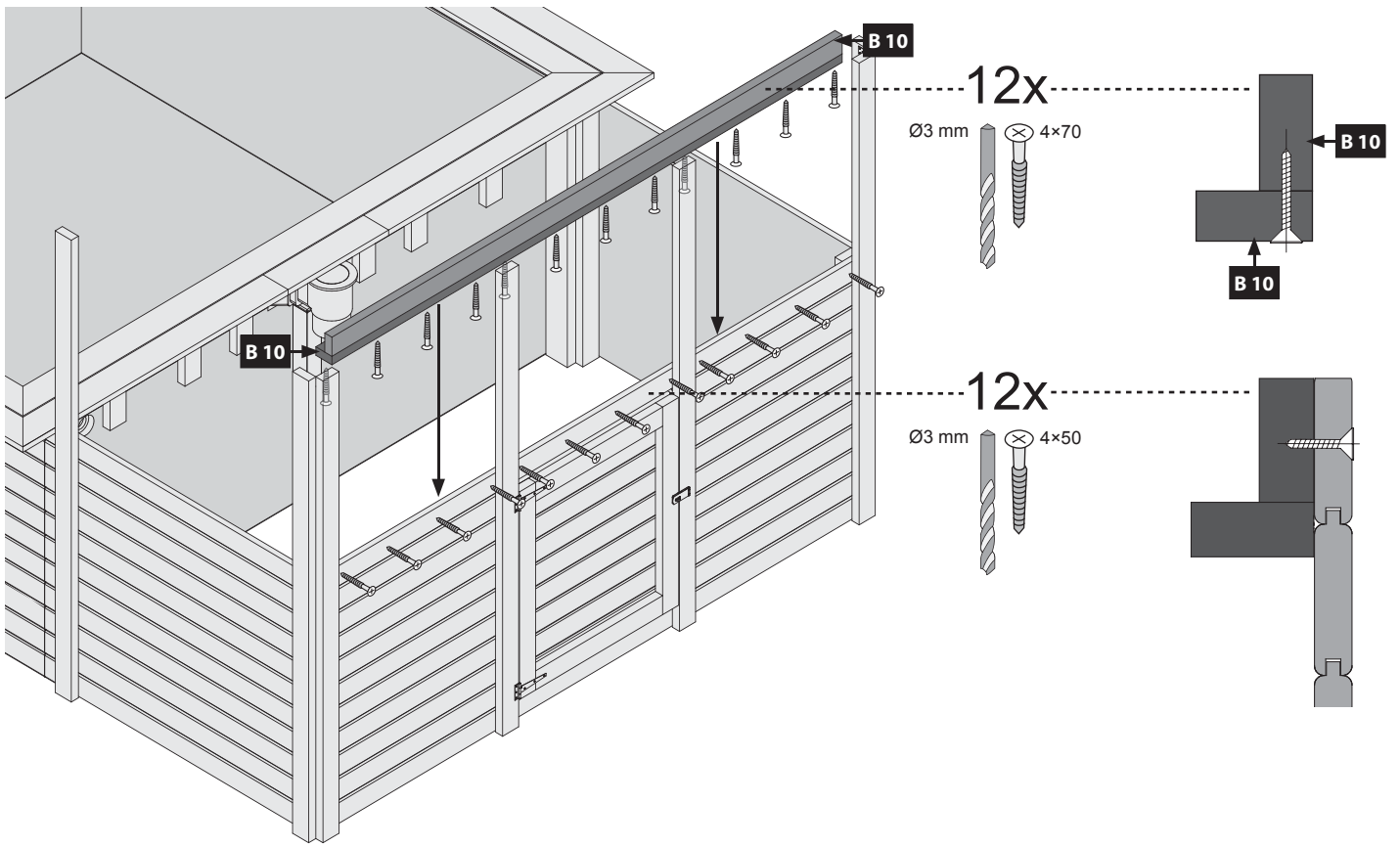

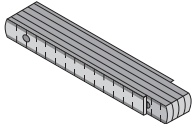
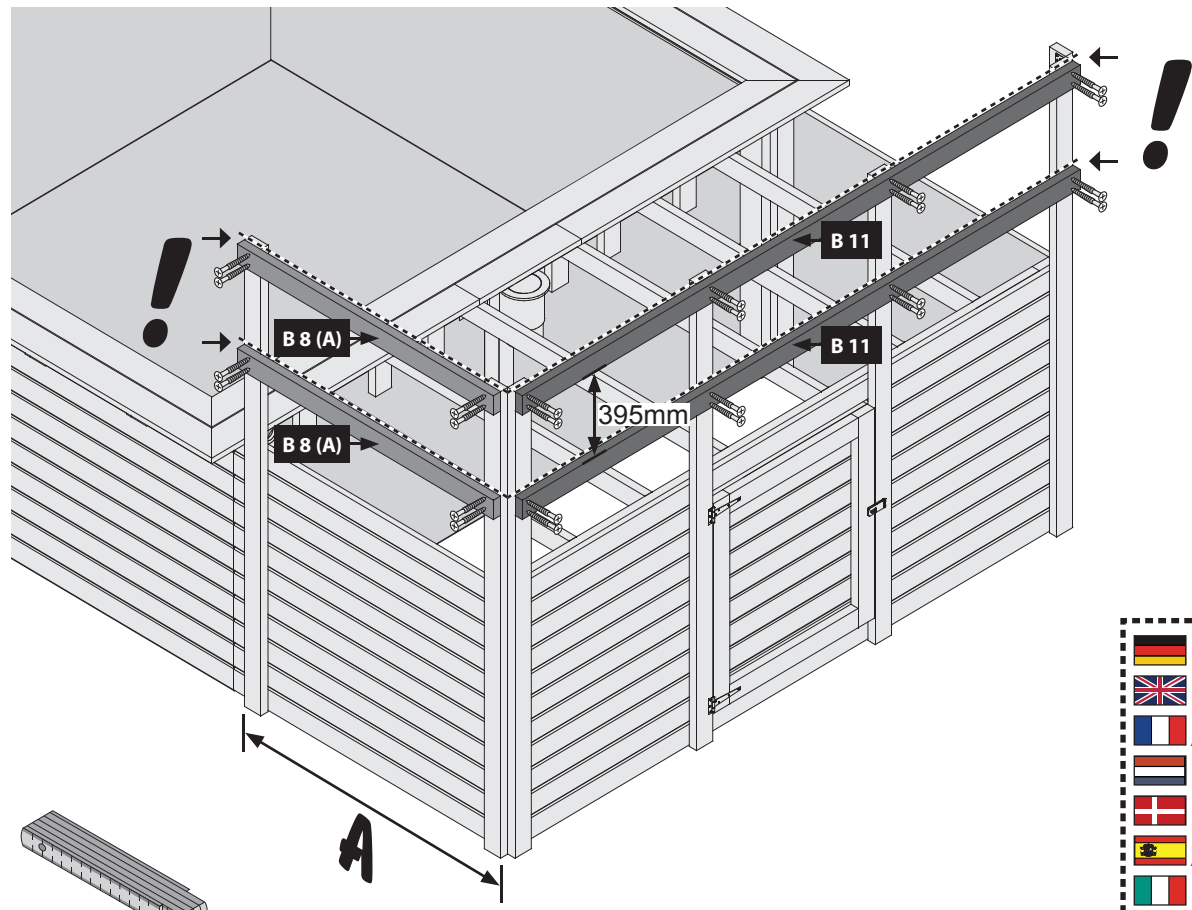

-  Bündig!
-  Flush!
-  Affleurement!
-  Gelijk!
-  I flugt!
-  Aras! ←
-  Combacia!
-  Stejný!

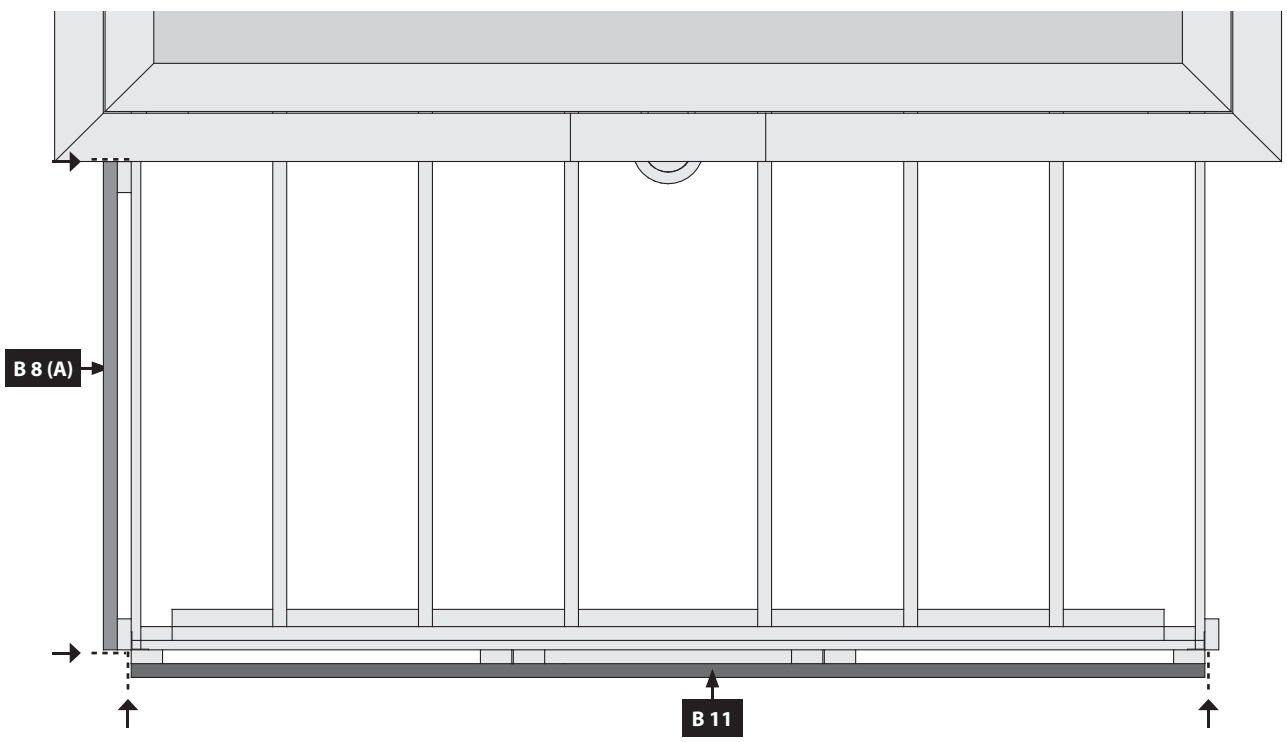
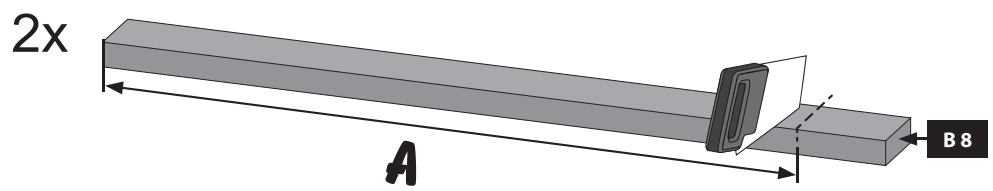

160x

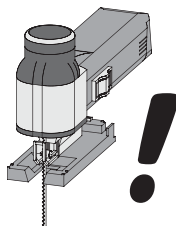
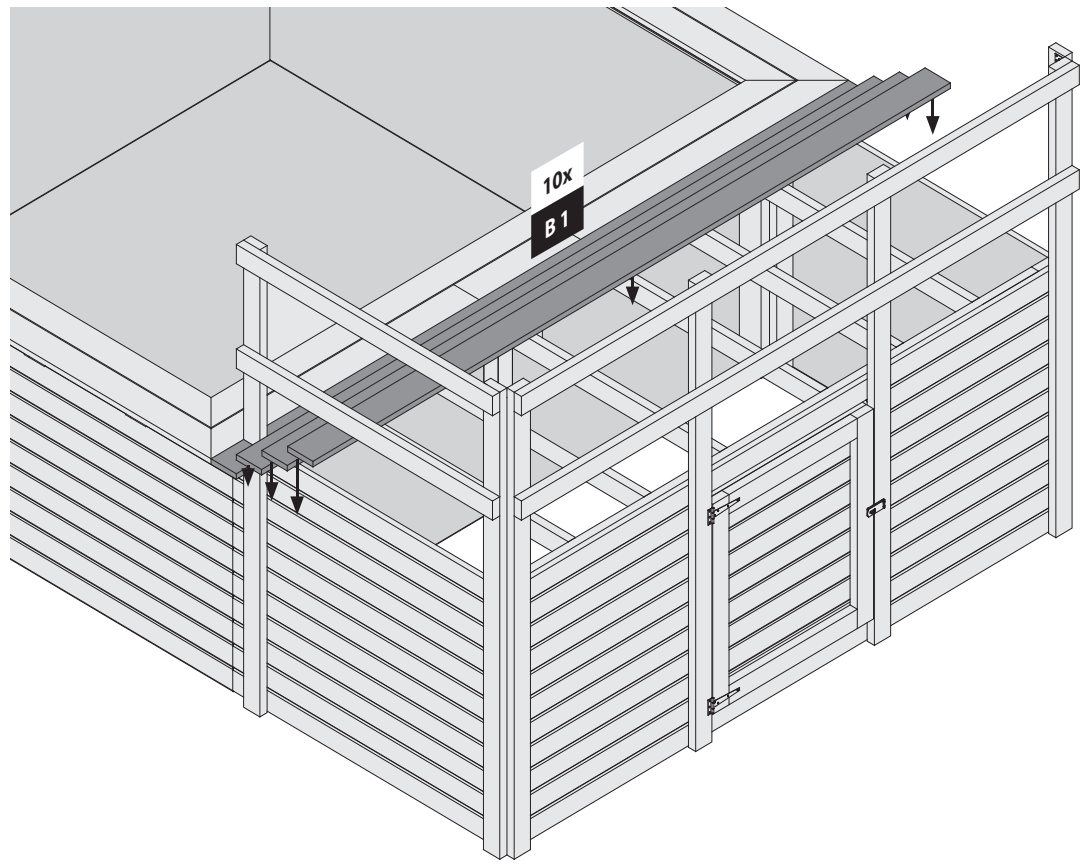
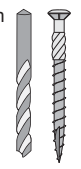

-  Bündig!
-  Flush!
-  Affleurement!
-  Gelijk!
-  I flugt!
-  Aras!
-  Combacia!
-  Stejný !

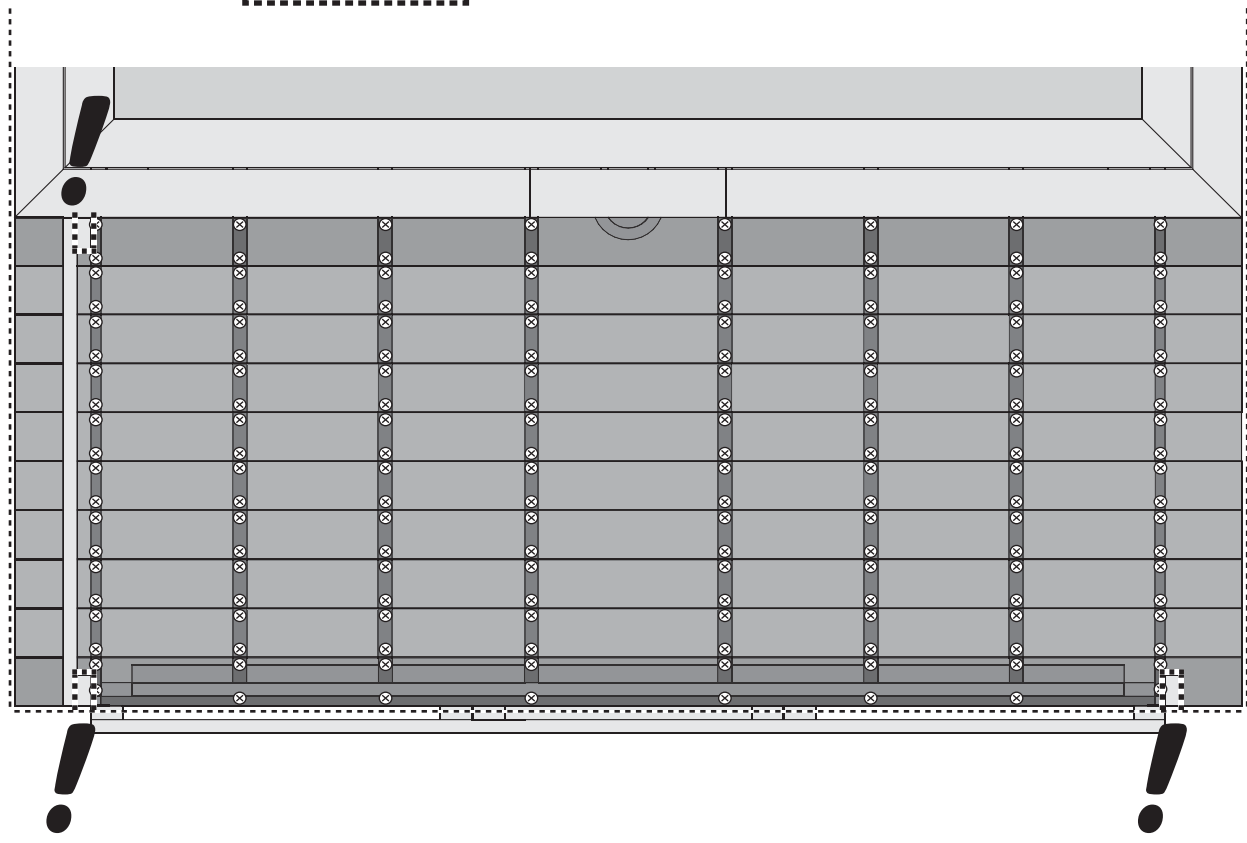
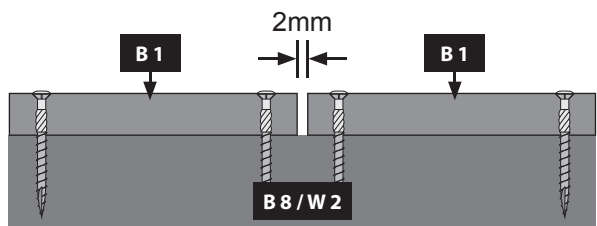

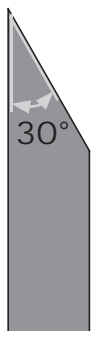
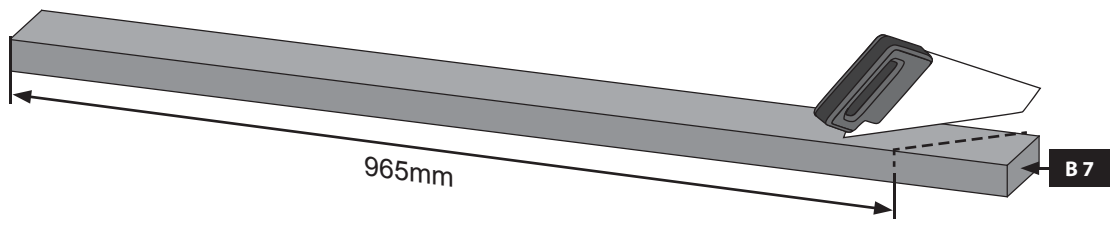
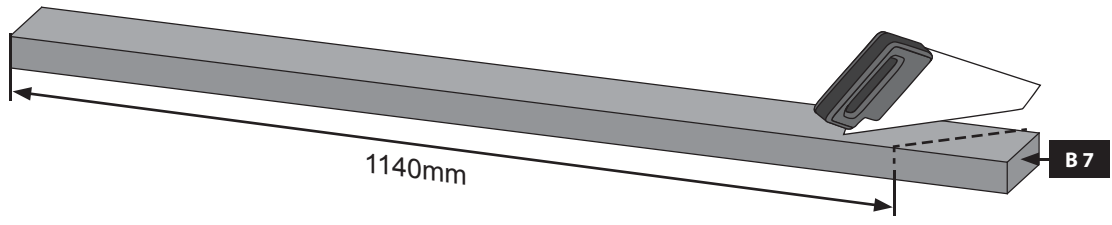
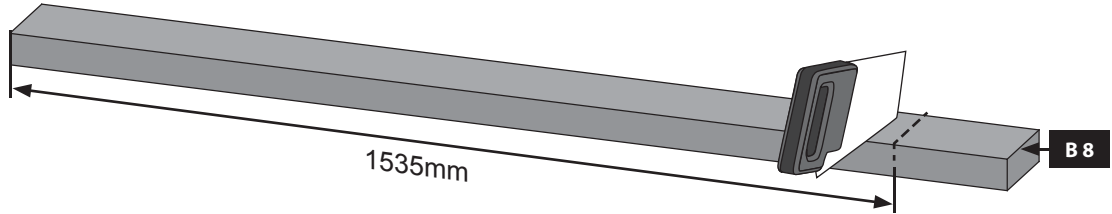
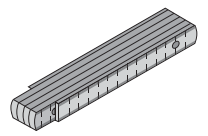

-  Bündig!
-  Flush!
-  Affleurement!
-  Gelijk!
-  I flugt!
-  Aras!
-  Combacia!
-  Stejný !

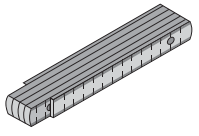

Ø3 mm 4x70
6x

Ø5 mm 6x100
4x

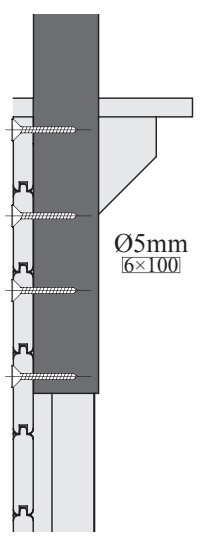
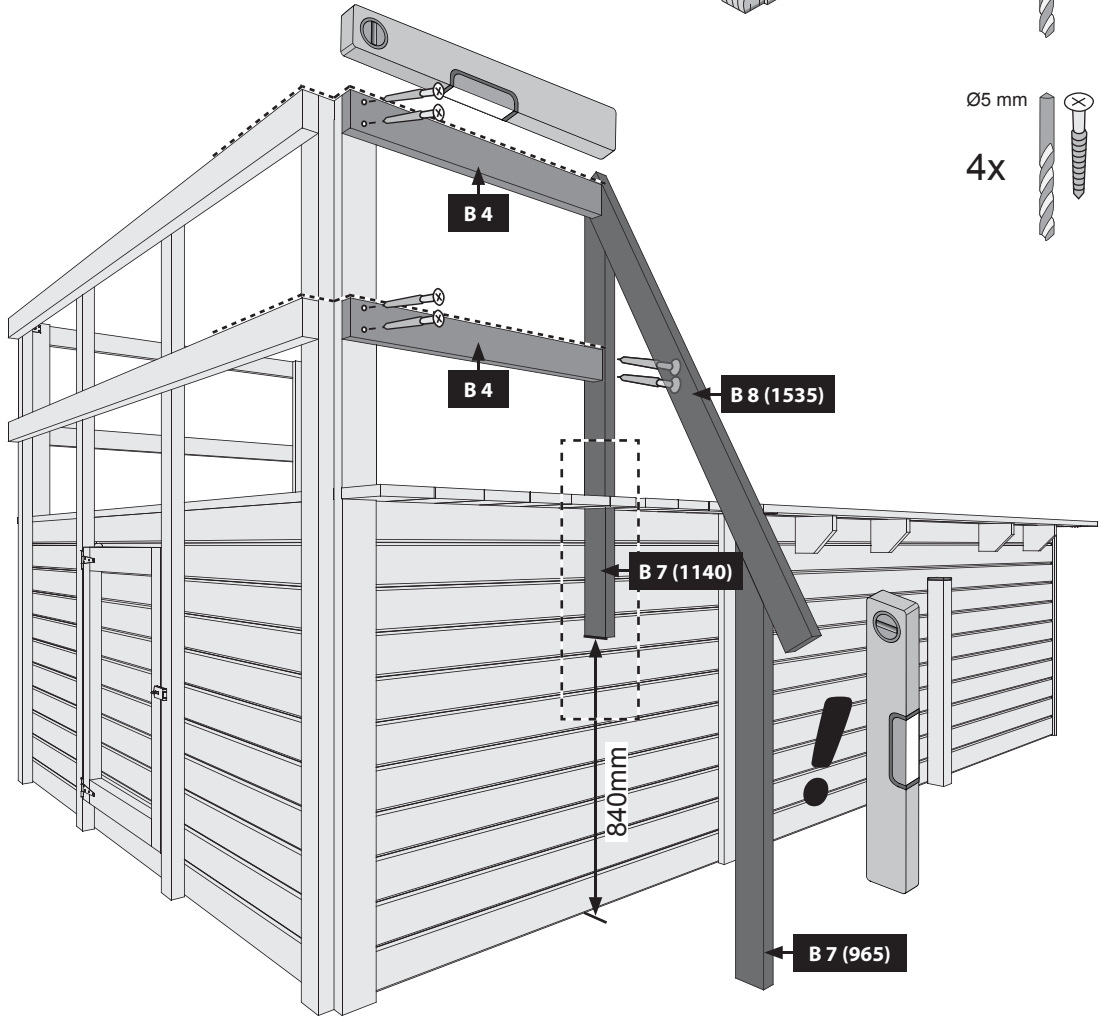

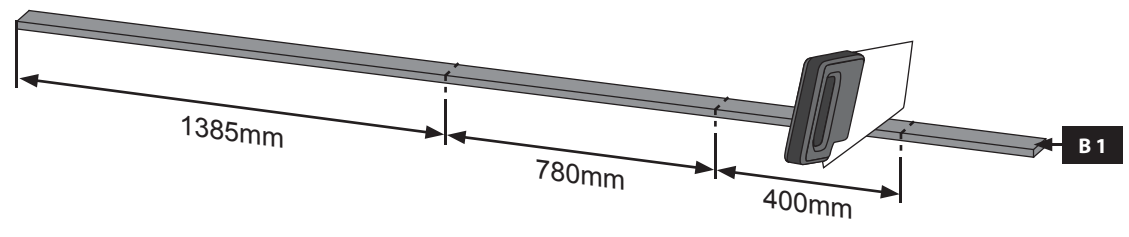
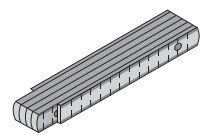
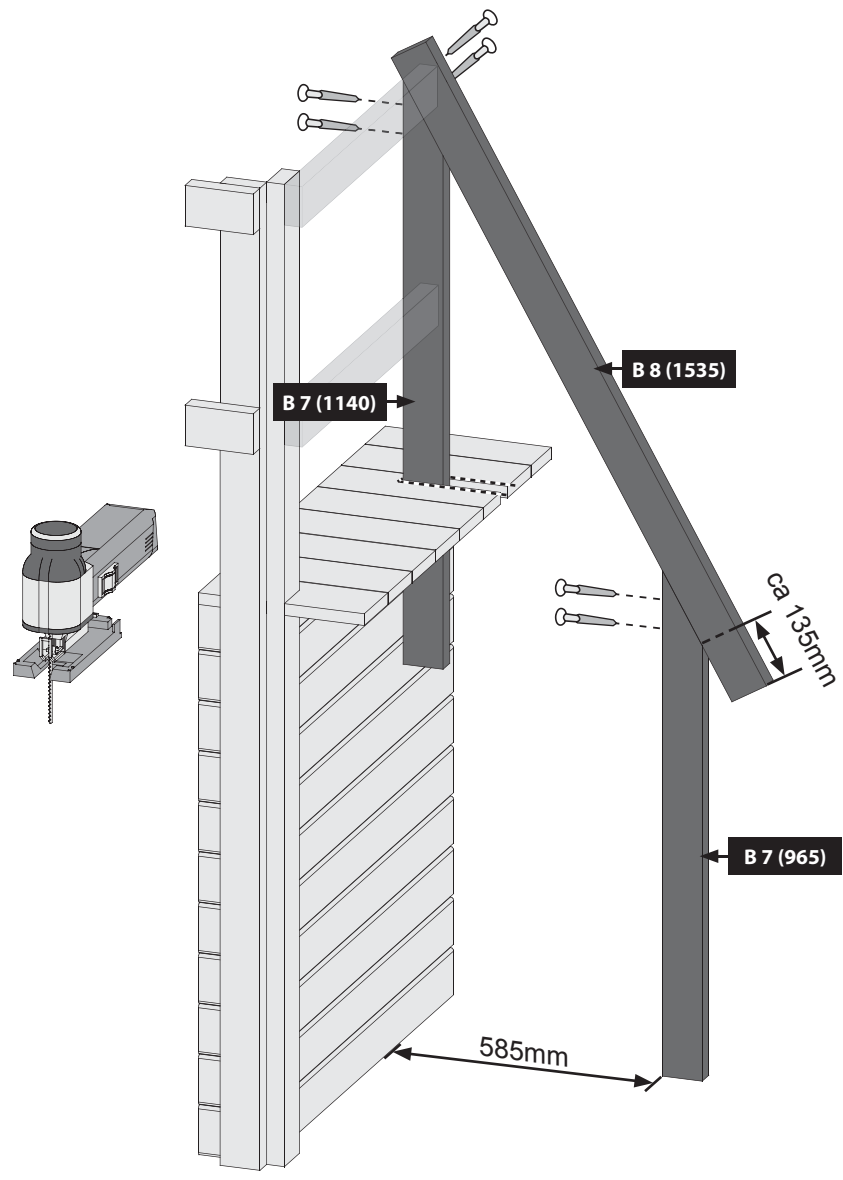
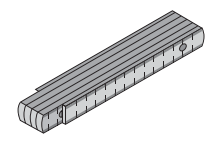
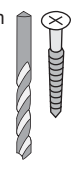

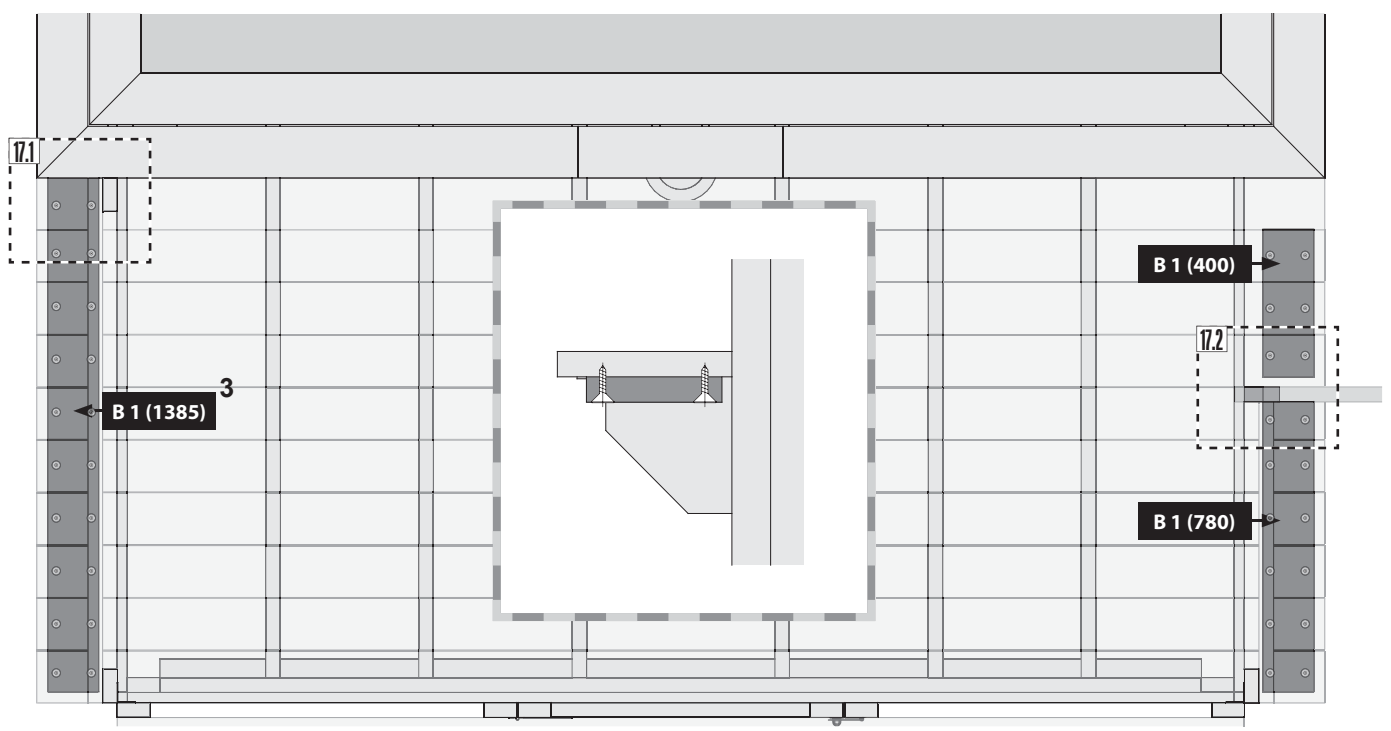
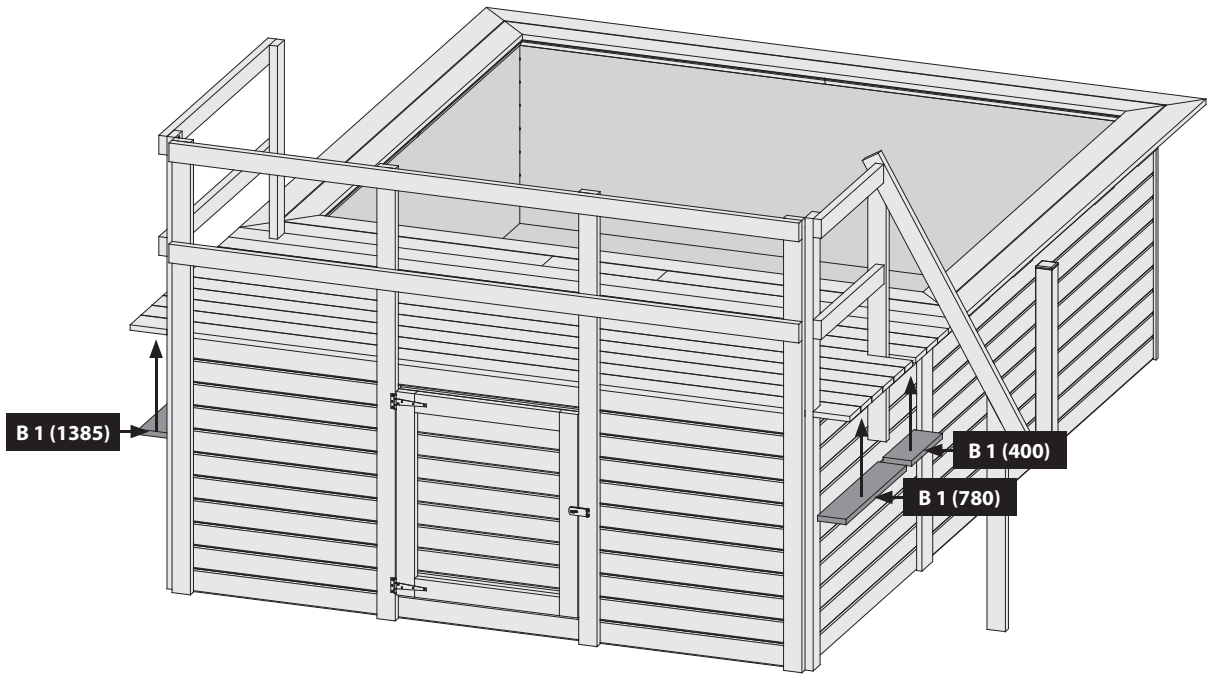

17.1

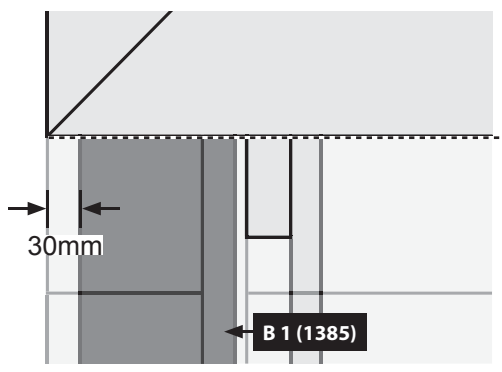

-  Bündig!
-  Flush!
-  Affleurement!
-  Gelijk!
-  I flugt!
-  Aras!
-  Combacia!
-  Stejný !

17.2

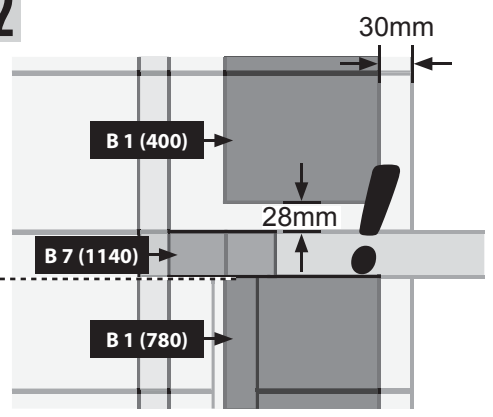

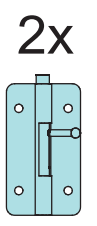
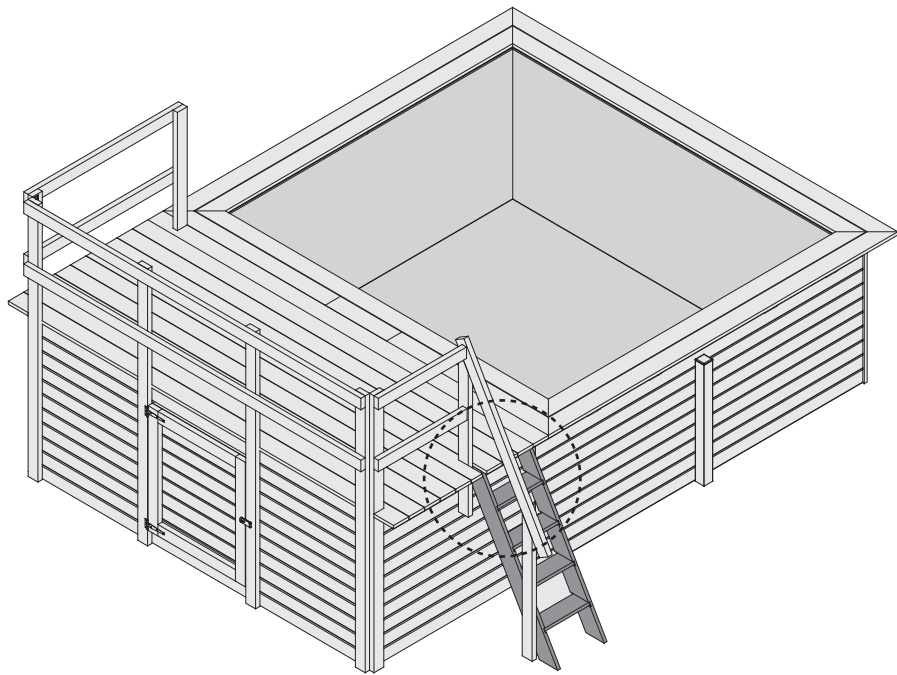

1.

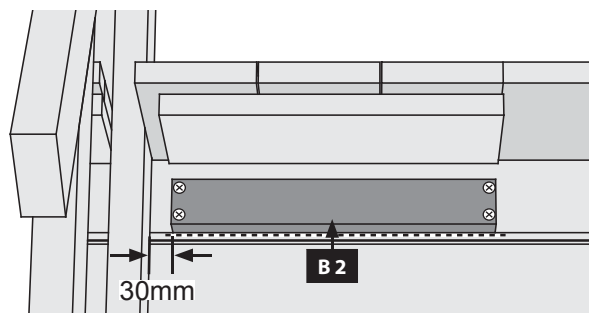

2.

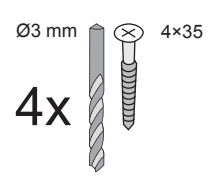
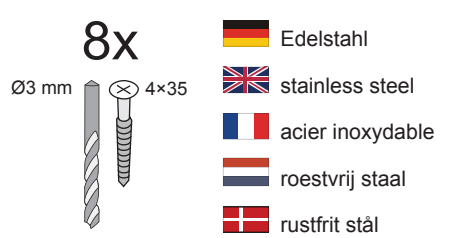
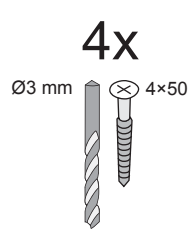
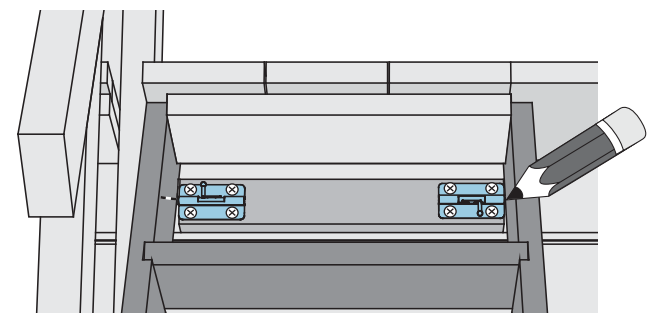

3.

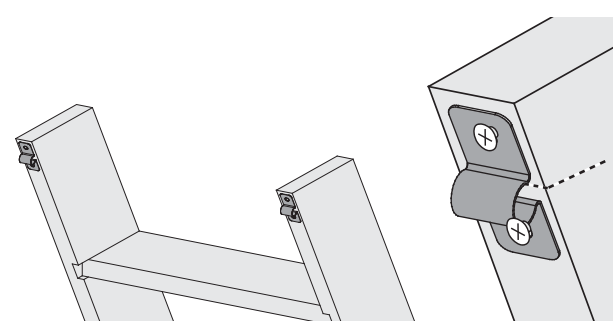

4.

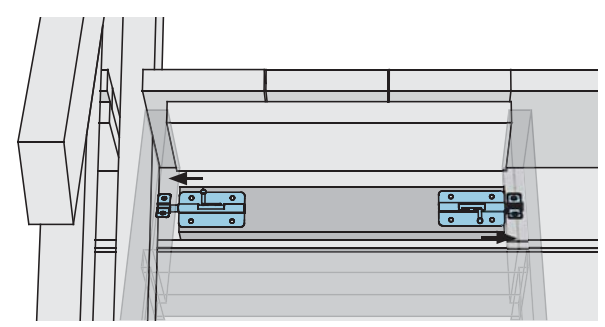

Ø8 mm 8x70
4x

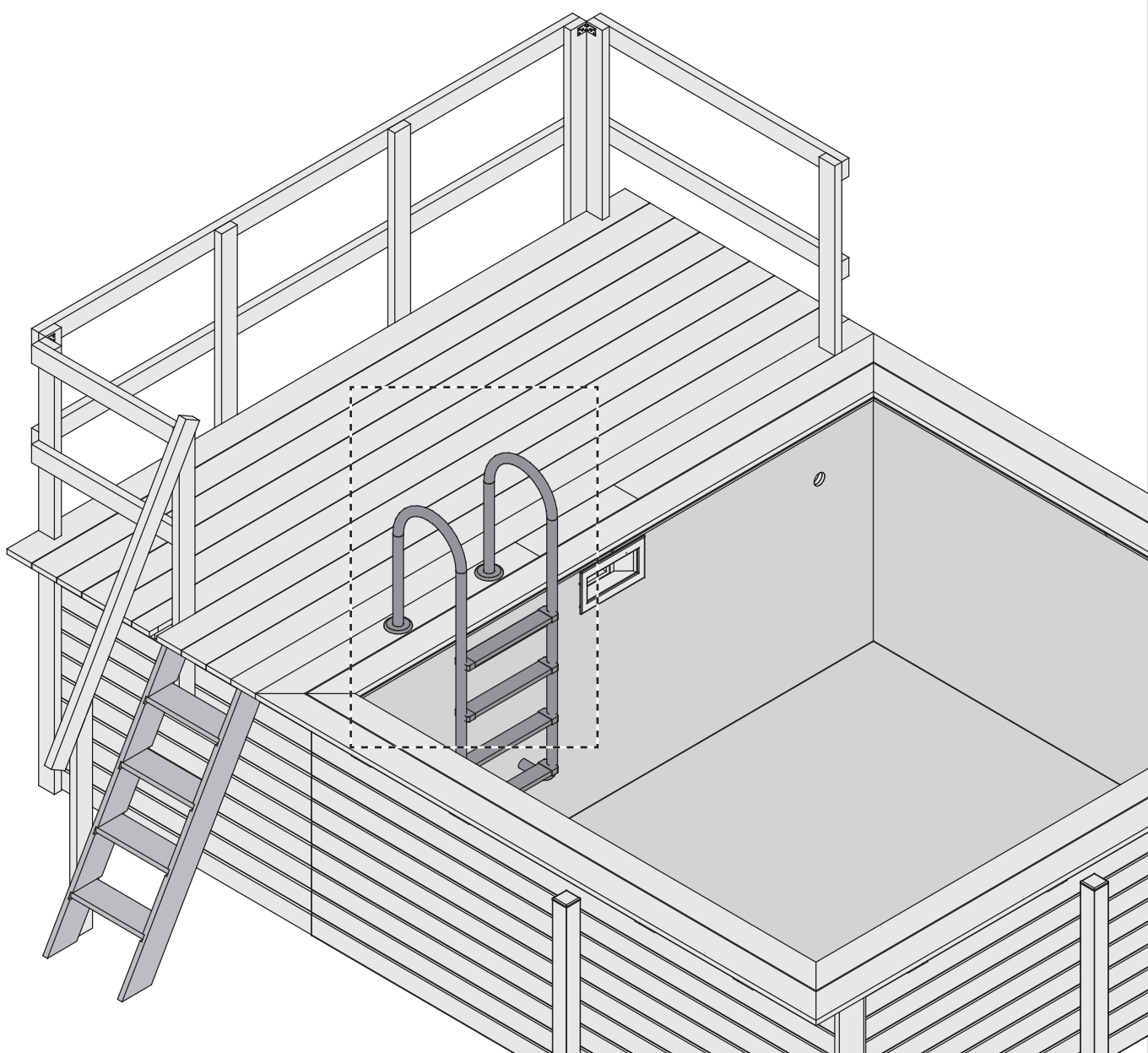
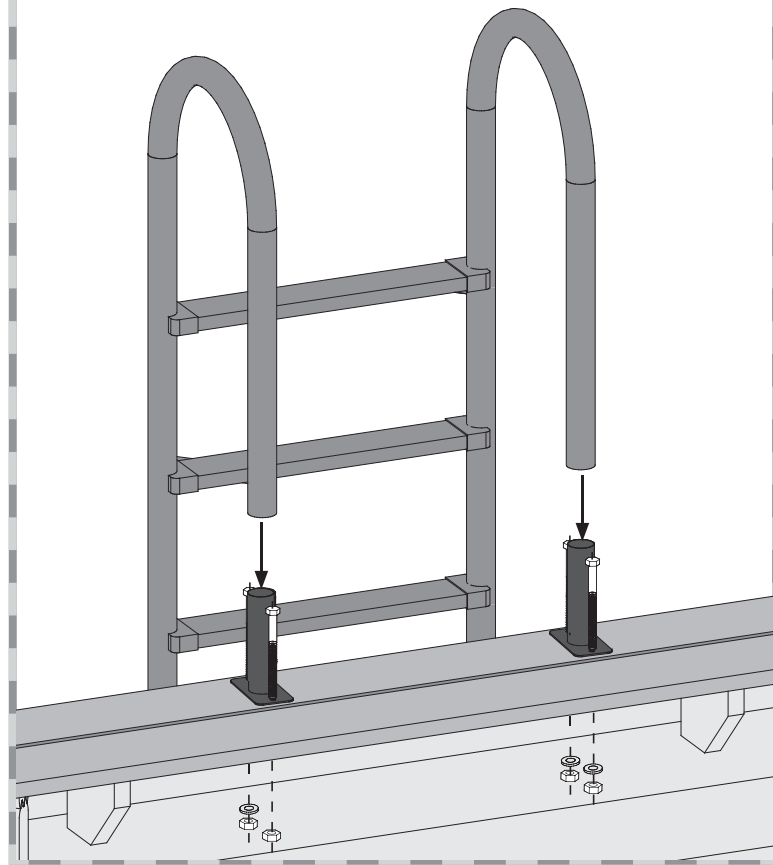

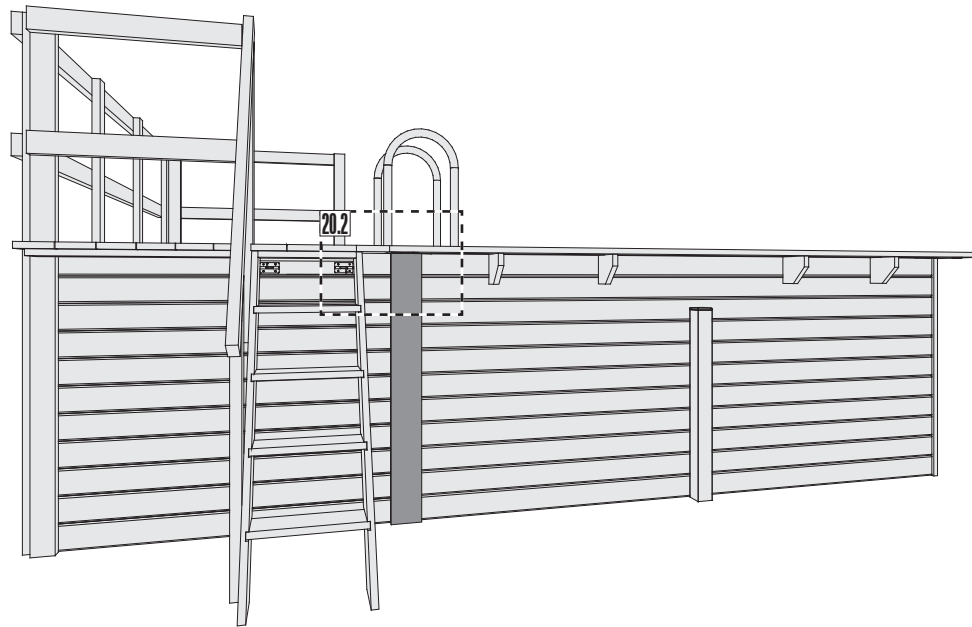

08.1

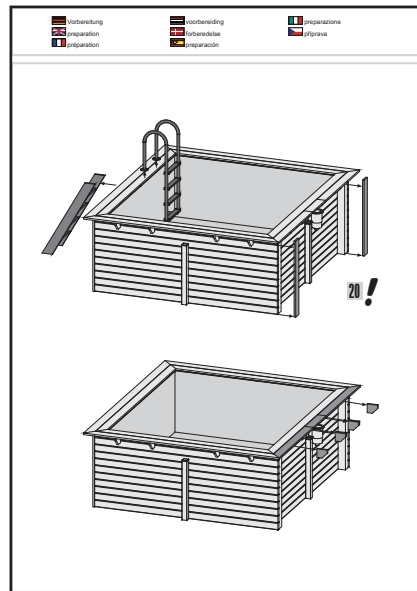
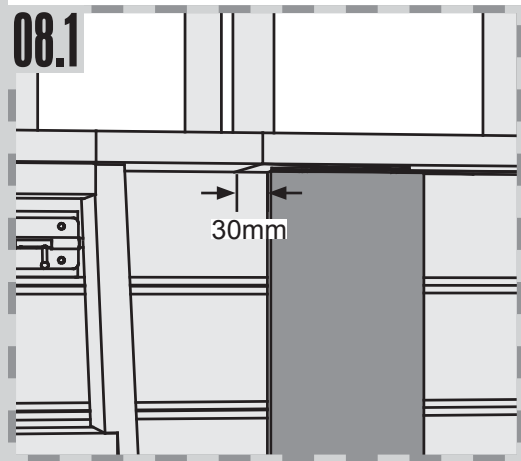

08.2

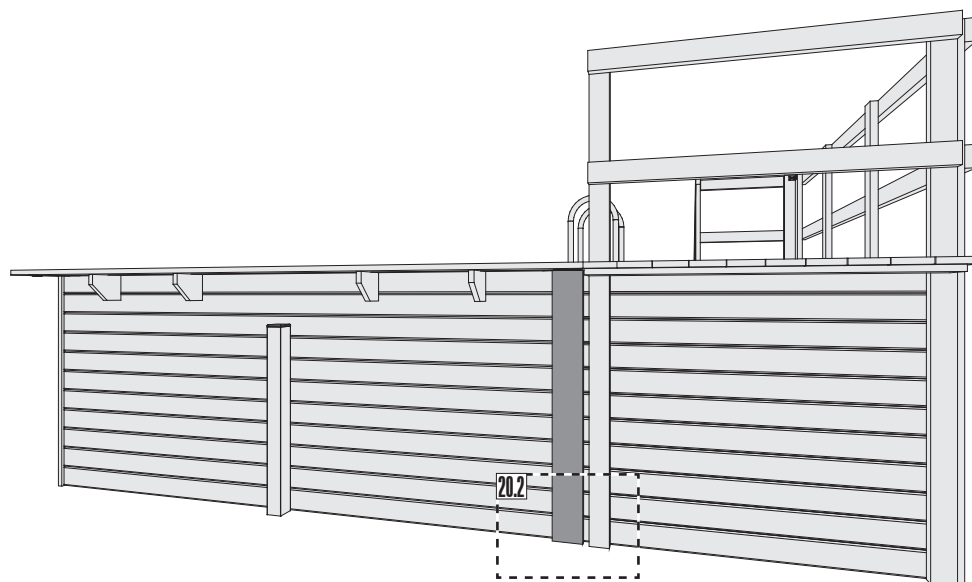
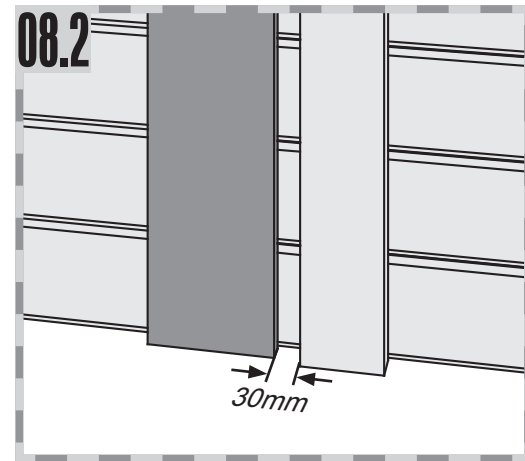

 **Poolpflege im Herbst und Winter**

- Ist der Pool von vielen Pflanzen und Bäumen umgeben, muss dieser regelmäßig vom Laub befreit werden. Sind dennoch Blätter auf den Grund gesunken, müssen diese aufgrund von Schlammabildung zeitnah entfernt werden. Für den entsprechenden Schutz empfehlen wir die Winterabdeckfolie aus unserem Sortiment!
- Im Winter sollte der Pool nicht komplett entleert werden, da seitlicher Eisdruck entstehen kann. Der Wasserstand sollte bis unter die oberen Einläufe abgesenkt werden (ca 10-15 cm unter der Düse) und konstant auf diesem Niveau gehalten werden!
- Alle frostgefährdeten Leitungen und die Filteranlage vollständig entleeren, reinigen und trocken/frostsicher einlagern. Dies gilt für alle Zubehörteile aus Kunststoff und solche, die eingetaucht werden. (Das 6-Wege-Ventil der Filteranlage auf ENTLEREEN stellen. Weiter sollte der Sandfilterdeckel geöffnet werden, damit Luft in das System gelangt. Durch das Öffnen der Entleerungsschraube am Filterkessel und an der Filterpumpe kann das Wasser nun ablaufen.)
- Den Vorfilterdeckel der Filterpumpe abnehmen und Sieb reinigen.
- Alle Betriebschalter auf AUS stellen und den Netzschalter ausschalten. Die Sicherungen entfernen.

 **Pool maintenance in autumn and winter**

- If the pool is surrounded by many plants and trees, it must be regularly removed from the leaves. nevertheless leaves are dropped to the ground, they must be removed promptly due to sludge formation. For the appropriate protection, we recommend the cover from our range!
- In winter, the pool should not be completely drained, because lateral ice pressure may arise. The water level should be lowered to below the upper inlets (About 10-15 cm below the nozzle) and held constant at this level are!
- Empty all frost exposed pipes and the filter system completely, clean and dry / store frost. This applies to all components of plastic and those which are immersed filters (The 6-way valve of the filter system to EMPTY. Next the sand filter cover should be opened to allow air into the system arrives. By opening the drain screw on the filter vessel and the filter pump the water can run now.)
- The preliminary filter, the filter pump and then clean sieve.
- Set all the power switch off and disconnect the mains cable. Remove the fuses.

 **Entretien de la piscine à l'automne et l'hiver**

- Si la piscine est entourée par de nombreuses plantes et des arbres, il doit être régulièrement retiré des feuilles. néanmoins les feuilles sont tombées à terre, ils doivent être rapidement retirés en raison de la formation de boues. Pour la protection appropriée, nous recommandons la couverture de notre gamme!
- En hiver, la piscine ne doit pas être complètement vidé, parce que la pression de la glace latérale peut se poser. Le niveau d'eau devrait être abaissé au-dessous des prises supérieures (environ 10-15 cm en dessous de la buse) être et maintenue constante à ce niveau!
- Videz les tuyaux de gel exposés et complètement le système de filtre, propre et sec / magasin gel. Cela vaut pour tous les éléments de plastique et ceux qui sont immergés. (Placez la vanne 6 voies du système de filtre à VIDER. Ensuite, le couvercle du filtre à sable doit être ouvert pour permettre à l'air dans le système. En ouvrant la vis de vidange sur la cuve de filtre et la pompe de filtration, l'eau peut maintenant procéder.)
- Le filtre préliminaire, la pompe à filtre et tamis puis nettoyer.
- Réglez tout l'appareil hors tension et débranchez le câble d'alimentation. Retirer les fusibles.

 **Zwembad onderhoud in de herfst en winter**

- Als het zwembad is omgeven door veel planten en bomen, het moet regelmatig worden verwijderd uit de bladeren. Toch bladeren viel op de grond, moeten zij onmiddellijk worden verwijderd als gevolg van slibvorming. Voor de juiste bescherming, raden we het deksel van ons assortiment!
- In de winter is het zwembad mag niet worden helemaal leeg, omdat zijdelingse ijs druk kunnen ontstaan. Het waterniveau worden verlaagd tot onder de bovenste inname (ongeveer 10-15 cm onder het mondstuk) en constant gehouden op dit niveau!
- Leeg alle vorst blootgesteld leidingen en het filter systeem volledig, schoon en droog / store vorst. Dit geldt voor alle onderdelen van kunststof en die zijn ondergedompeld. (Plaats de 6-weg klep van het filtersysteem te legen. Vervolgens wordt de zandfilter kap moet worden geopend om lucht in het systeem. Door het openen van de afvoer schroef op de filter vat en de filter pomp, het water kan nu verder gaan.)
- Het voorfilter, het filter pomp en vervolgens schoon zeef.
- Zet de stroom uit te schakelen en de stekker uit het netsnoer. Verwijder de zekeringen.

 **Mantenimiento de la piscina en otoño e invierno**

- Si la piscina está rodeada de muchas plantas y árboles, se debe retirarse periódicamente las hojas. sin embargo, las hojas se dejan caer al suelo, deben ser eliminado rápidamente debido a la formación de lodos. Para la protección adecuada, se recomienda la tapa de nuestra gama!
- En invierno, la piscina no debe ser completamente agotada, porque puede surgir la presión del hielo lateral. El nivel del agua debe ser bajado por debajo de las ingestas superiores (unos 10-15 cm por debajo de la boquilla) y se mantuvo constante a este nivel!
- Vaciar todas las tuberías heladas expuesta y el sistema de filtro por completo, limpio y seco / tienda de heladas. Esto se aplica a todos los componentes de plástico y los que están inmersos. (Coloque la válvula de 6 vías del sistema de filtro en VACÍO. A continuación, la tapa del filtro de arena debe ser abierta para permitir que el aire en el sistema. Con la apertura de la válvula de drenaje en el recipiente del filtro y la bomba del filtro, el agua puede ahora proceder.)
- El filtro previo, la bomba de filtro y tamiz luego limpia.
- fijado todo el interruptor de encendido y desconecte el cable de red. Retire los fusibles.

 **Manutenzione della piscina in autunno e inverno**

- Se la piscina è circondata da molte piante e alberi, deve essere rimosso regolarmente dalle foglie. tuttavia le foglie sono caduti a terra, essi devono essere rimosso prontamente a causa della formazione di fanghi. Per la protezione del caso, si consiglia la copertura della nostra gamma!
- In inverno, la piscina non dovrebbe essere completamente scarica, perché la pressione del ghiaccio laterale può sorgere. Il livello dell'acqua dovrebbe essere abbassato al di sotto le prese superiori (circa 10-15 cm sotto l'ugello) essere e mantenuta costante a questo livello!
- Svuotare tutti i tubi di gelo a vista e il sistema di filtraggio completamente, pulito ed asciutto / store gelo. Questo vale per tutti i componenti in plastica e quelli che sono immersi. (Posizionare la valvola 6 vie del sistema di filtrazione a vuoto. Successivamente il coperchio del filtro sabbia deve essere aperto per consentire aria nel sistema. Aprendo la vite di scarico sulla nave filtro e la pompa del filtro, l'acqua può ora procedere.)
- Il filtro preliminare, la pompa filtro e vaglio quindi pulita.
- Impostare tutto il potere spegnere e scollegare il cavo di alimentazione. Rimuovere i fusibili.

 **Údržba na podzim av zimě bazén**

- Pokud je bazén obklopen mnoha rostlin a stromů, musí být pravidelně odstraňovány z listů. Nicméně listy jsou spadl na zem, musí být neprodleně odstranit v důsledku tvorby kalu. Za vhodnou ochranou, doporučujeme kryt z naší nabídky!
- V zimě, bazén by neměly být zcela vypuštěny, protože mohou vzniknout boční tlak ledu. Hladina vody by měla být snížena pod horními vstupy (cca 10 až 15 cm pod tryskou), se udržuje konstantní, a na této úrovni!
- Prázdná všechny mráz vystavení potrubí a filtrační systém zcela čistý a suchý / sklad mrazu. To platí pro všechny součásti z plastů a ty, které jsou ponořeny. (Umístěte 6-cestný ventil filtračního systému na prázdný. Dále je kryt pískový filtr by měl být otevřený, aby vzduchu do systému. Otevřením vypouštěcího šroubu na filtrační nádoby a filtrační čerpadla, voda může nyní pokračovat.)
- Předběžný filtr, filtr čerpadla a pak čisté síto.
- Nastavte všechny hlavní vypínač a odpojte napájecí kabel. Vyjměte pojistky.

