

- (D)** Montageanleitung
- (NL)** Handleiding voor de montage
- (HU)** Szerelési útmutató
- (GB)** Assembly instructions
- (PL)** Instrukcja montażu
- (RO)** Instrucțiuni de montaj

- (FR)** Notice de montage
- (CZ)** Montážní návod
- (TR)** Montaj talimatı
- (IT)** Istruzioni di montaggio
- (SK)** Návod na montáž
- (RU)** Инструкция по монтажу

Service • Assistenza • Dienstverlening • Serwis  
 Servis • Szerviz • Сервисная служба

Name • Nom • Nome • Naam • Nazwa • Jméno • Názov • Név • Denumire • Isim • Название	
Nr. • No. • N° • Номер • Č • Sz	
Тур • Туре • Тір • Тірус • Тіро • Тип	

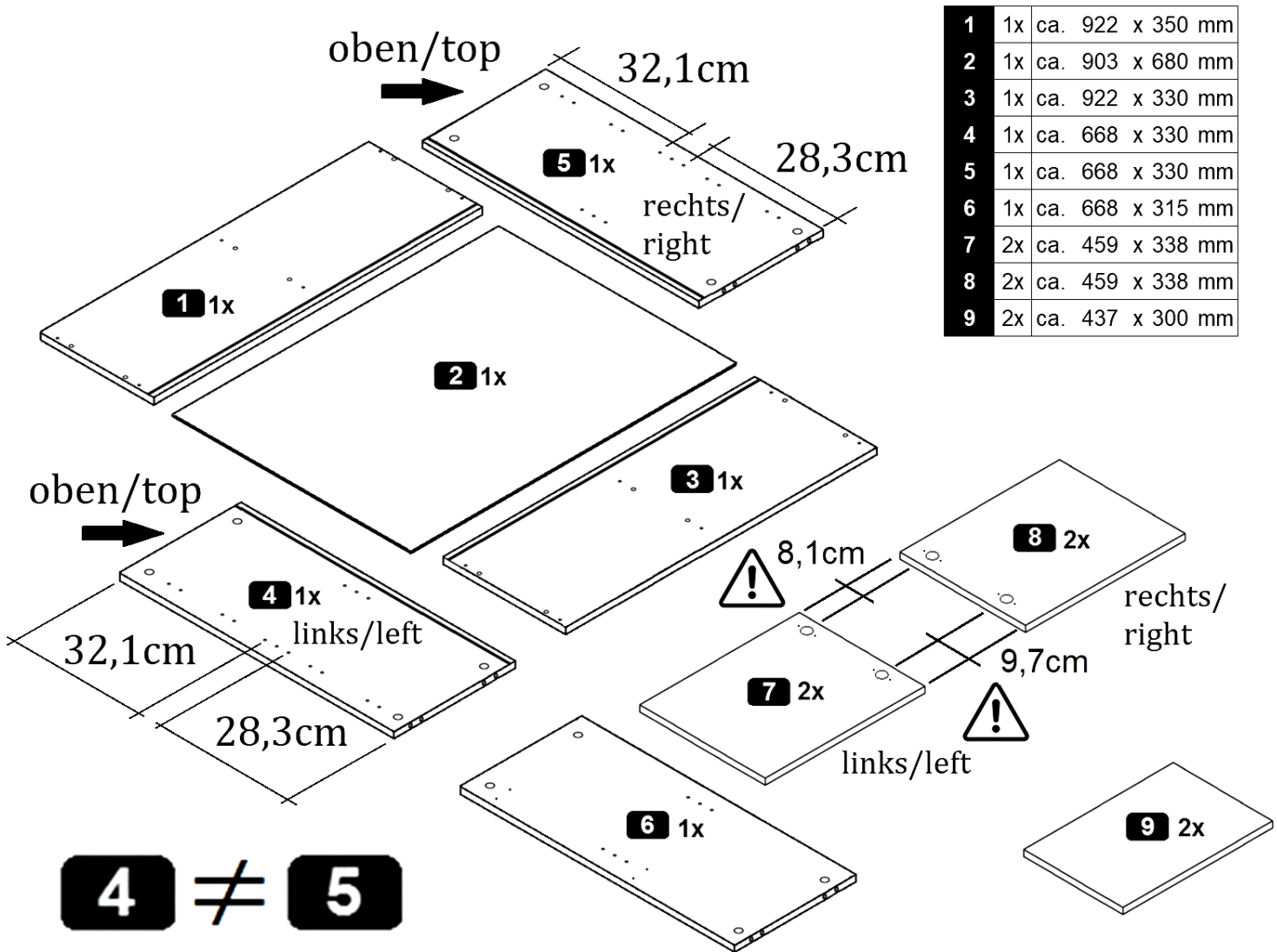
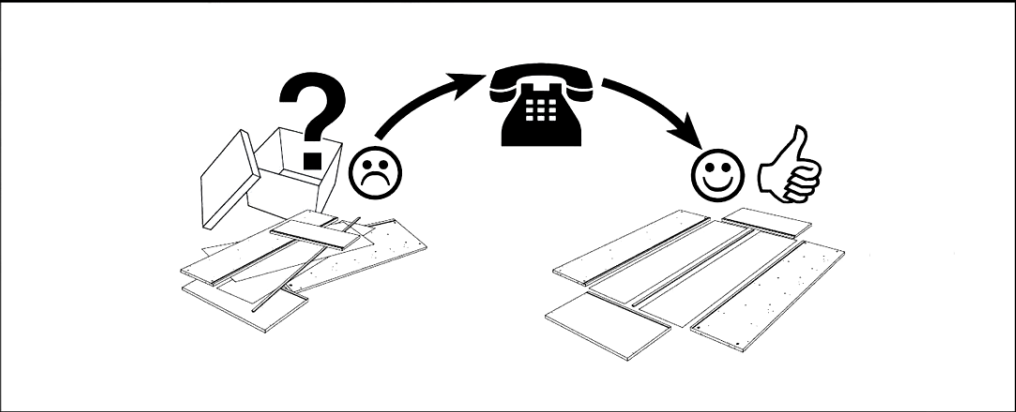
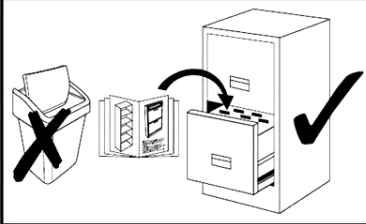

1	1x	ca. 922 x 350 mm
2	1x	ca. 903 x 680 mm
3	1x	ca. 922 x 330 mm
4	1x	ca. 668 x 330 mm
5	1x	ca. 668 x 330 mm
6	1x	ca. 668 x 315 mm
7	2x	ca. 459 x 338 mm
8	2x	ca. 459 x 338 mm
9	2x	ca. 437 x 300 mm

**4** ≠ **5**

**7** ≠ **8**



<b>A</b> 8,0 x 30 mm  12x	<b>B</b>  12x	<b>C</b>  12x	<b>D</b>  4x	<b>E</b> 3,5 x 9,5 mm  8x	<b>F</b>  5x	<b>G</b> 4,0 x 20 mm  5x
<b>H</b> Ø35 Kr.0 3,5x13mm  8x	<b>I</b> h=2  8x	<b>J</b>  8x	<b>K</b> 2,7 x 20 mm  6x			

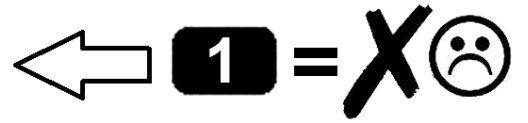
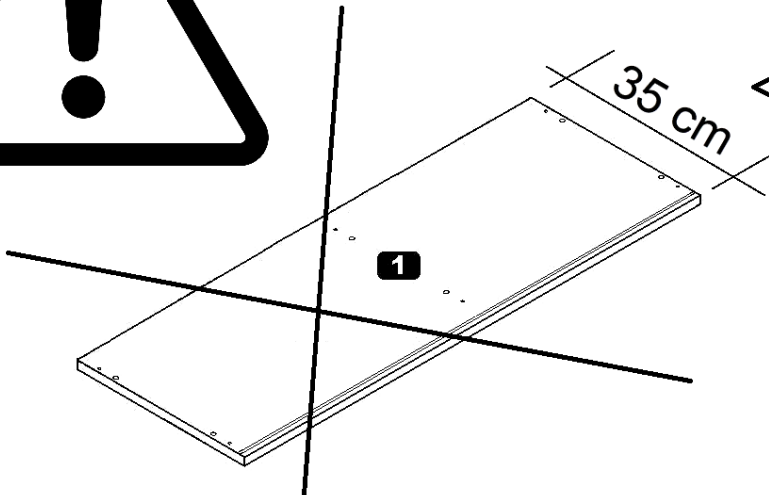
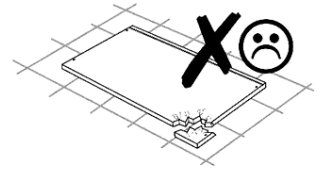
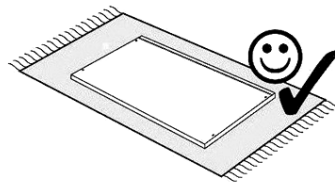



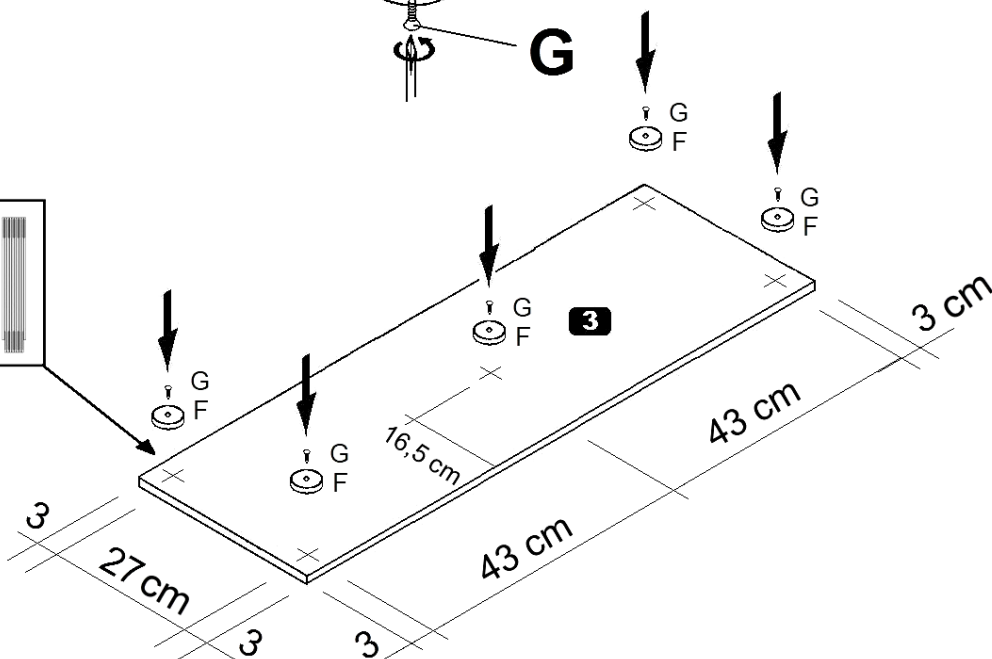
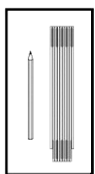
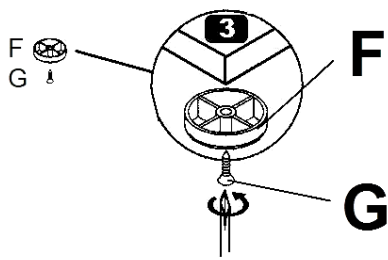
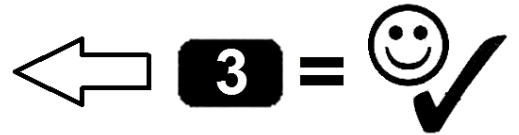
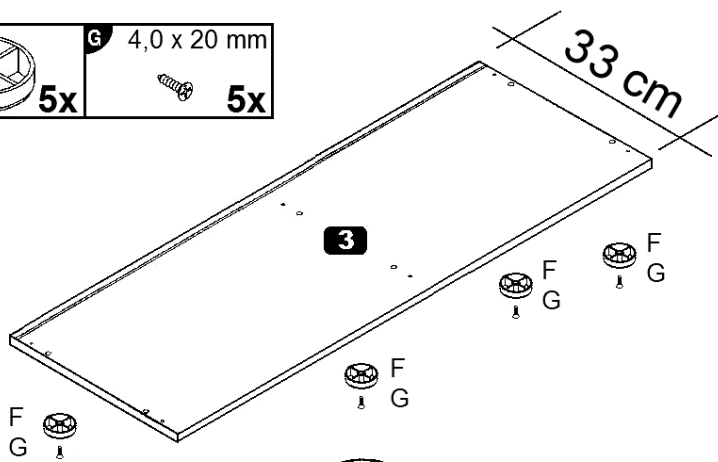
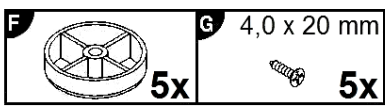

**1**

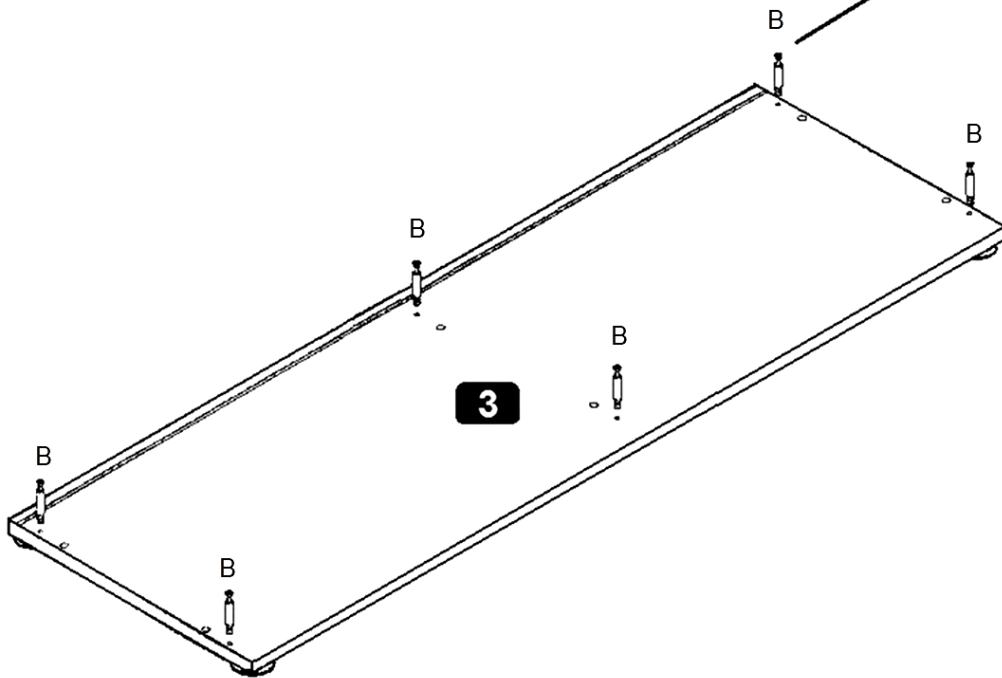
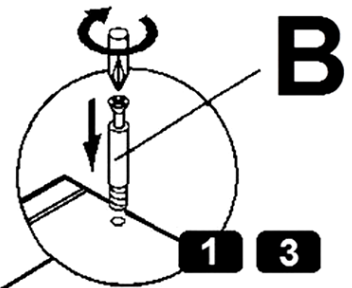
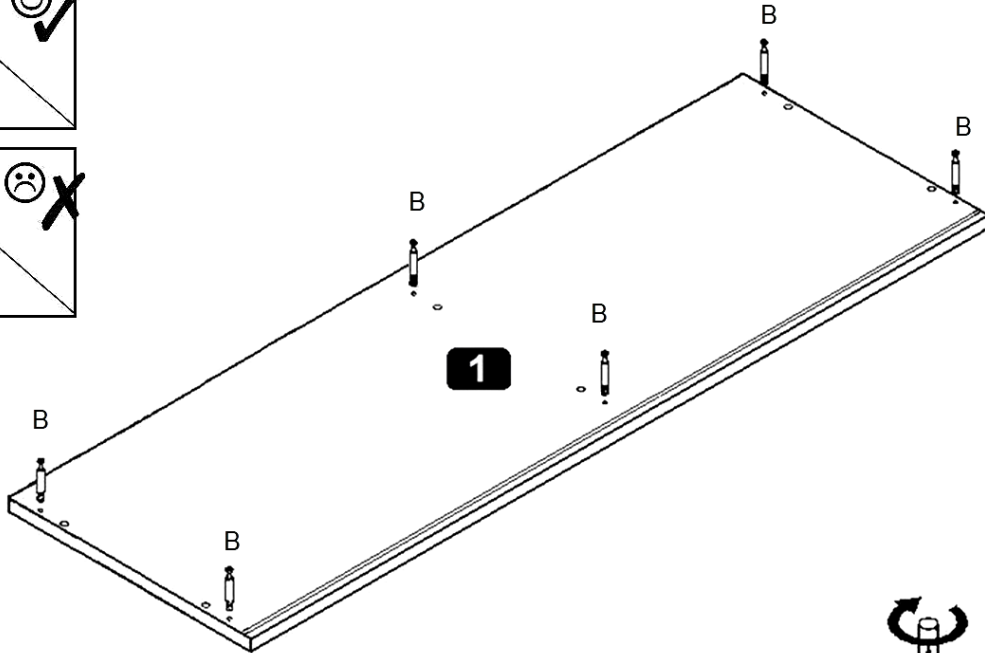
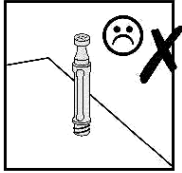
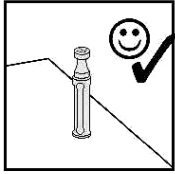
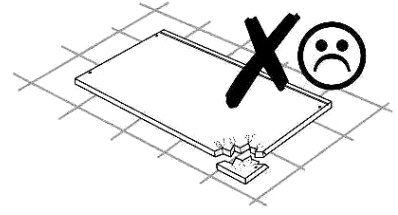
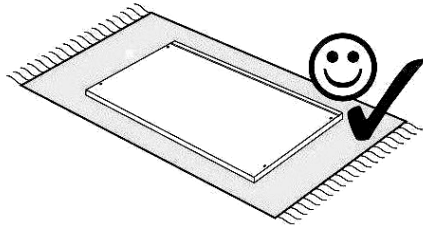
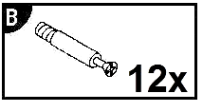

# 2



# 3

<b>A</b> 8,0 x 30 mm  12x	<b>C</b>  12x	<b>D</b>  4x	<b>E</b> 3,5 x 9,5 mm  8x	<b>I</b> h=2  8x
---	---	--	---	--

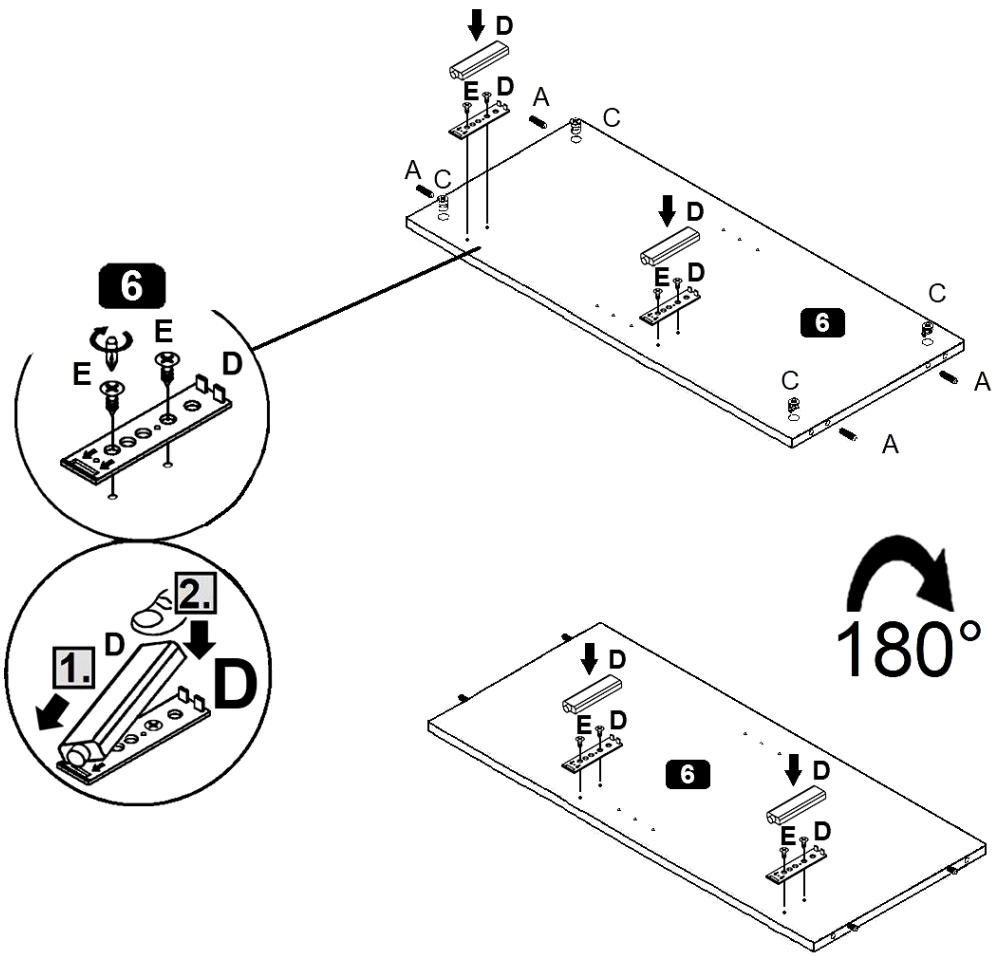
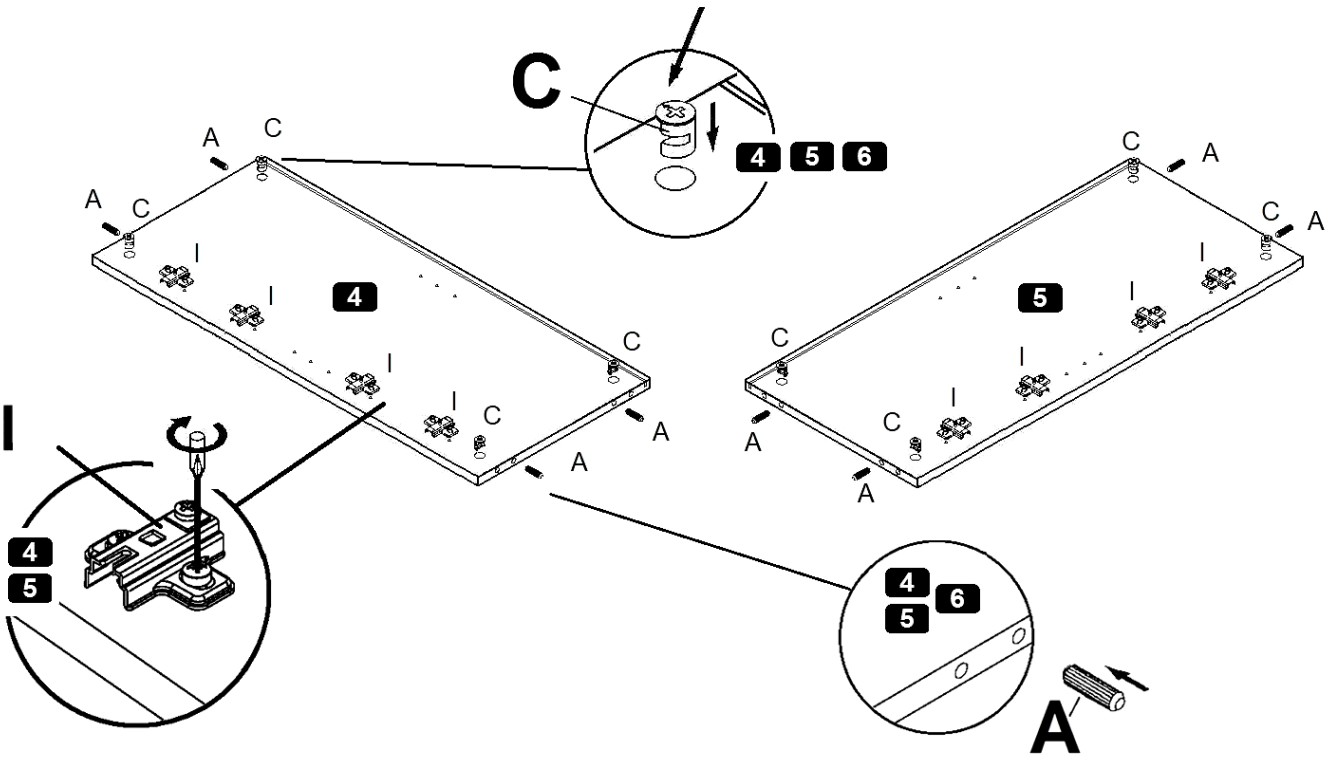
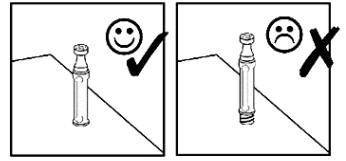

**4**

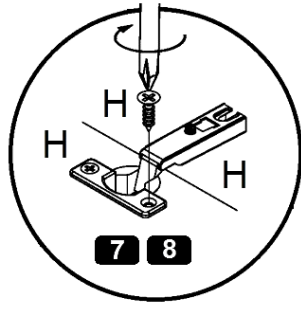
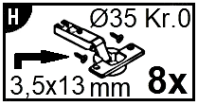

**7** ≠ **8**

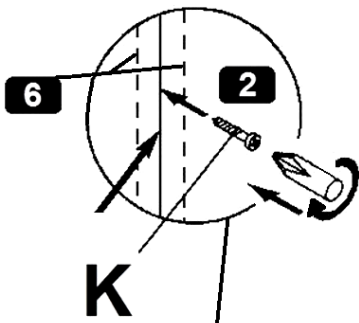
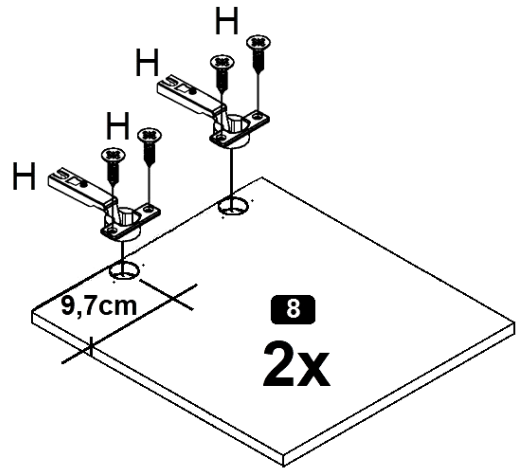
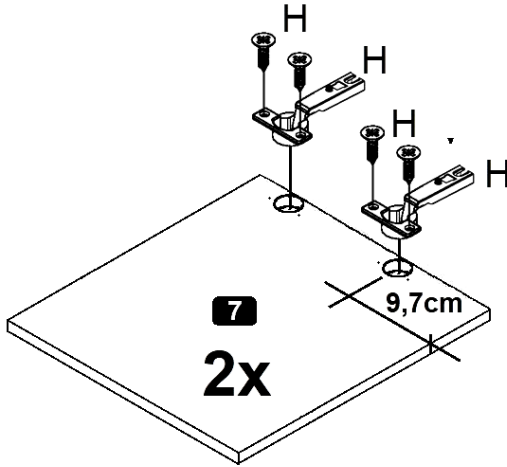

**4** ≠ **5**

**5**

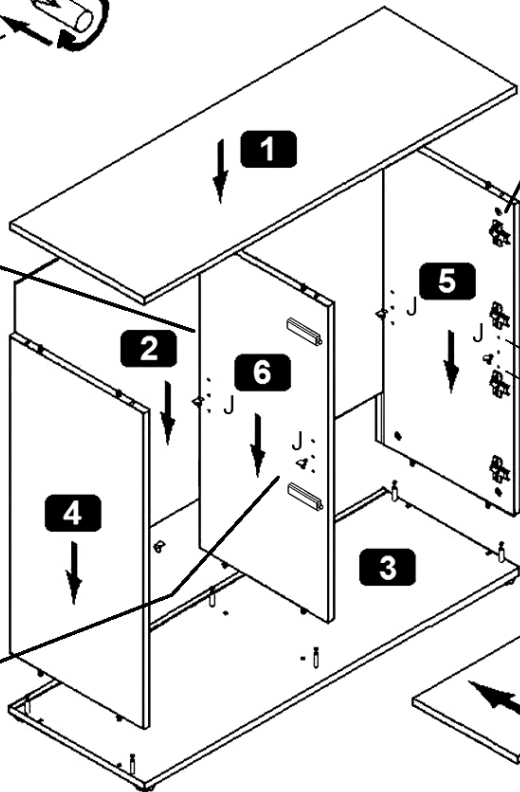
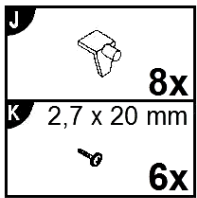

32,1cm

28,3cm

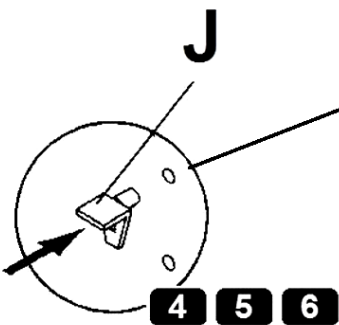



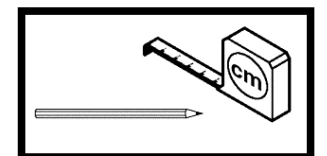

**4** = links / left

**5** = rechts / right

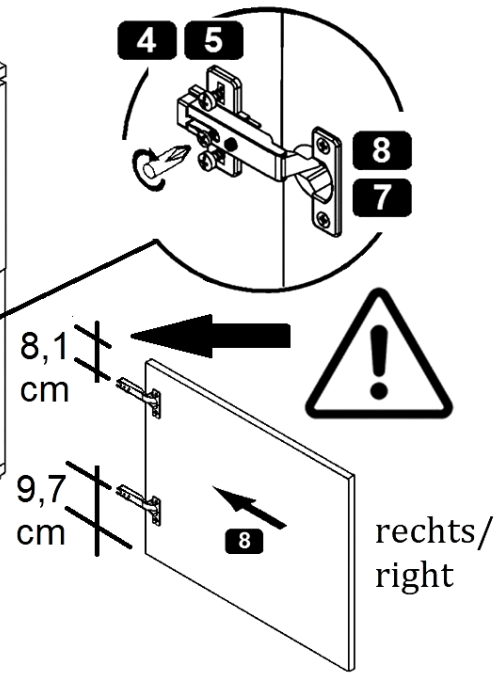
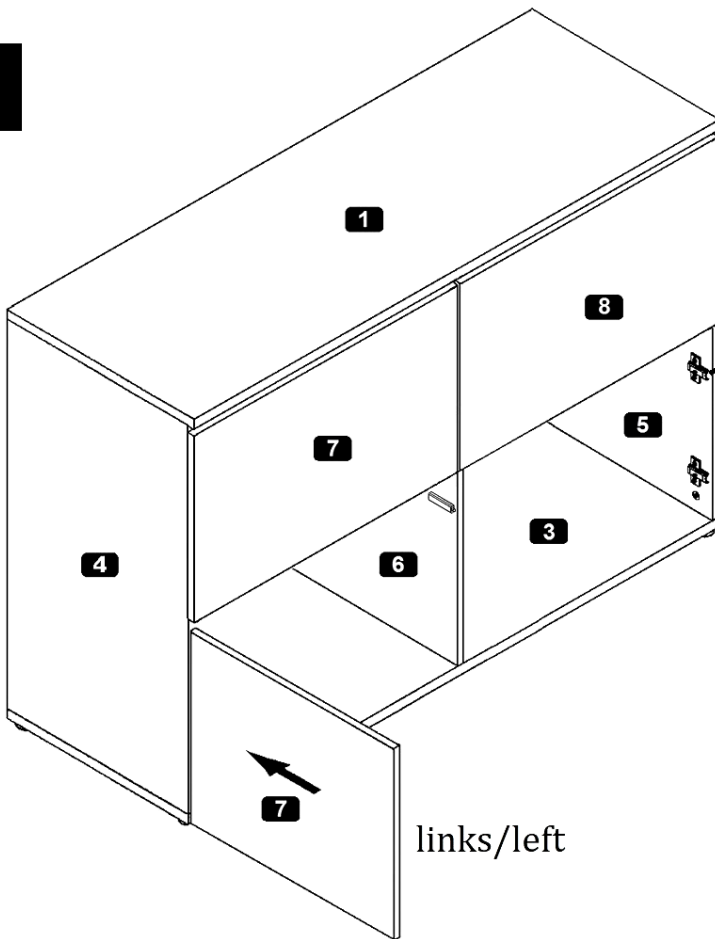

6

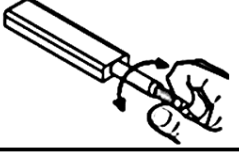

 <b>8 / 9</b> 	
	
<p>(D) <b>Push-To-Open einstellen</b></p> <p>(GB) Adjusting the Push-To-Open</p> <p>(FR) <b>Régler les Push-To-Open</b></p> <p>(IT) Sistemare Push-To-Open</p> <p>(NL) <b>Push-To-Open instellen</b></p> <p>(PL) Nastawić Push-To-Open</p> <p>(CZ) <b>Vyrovnejte Push-To-Open</b></p> <p>(RO) Nastavenie Push-To-Open</p> <p>(HU) <b>Állítsa be az Push-To-Open</b></p> <p>(SK) Reglare Push-To-Open</p> <p>(TR) <b>Push-To-Open ayarlanması</b></p> <p>(RU) Регулировка Push-To-Open</p>	

 <b>9 / 9</b> 	
	
<p>(D) <b>Türen einstellen</b> (Scharniere justieren)</p> <p>(GB) Adjusting the doors (adjusting the hinges)</p> <p>(FR) <b>Régler les portes</b> (ajuster les charnières)</p> <p>(IT) Sistemare le porte (regolare le cerniere)</p> <p>(NL) <b>Deuren instellen</b> (scharnieren afstellen)</p> <p>(PL) Nastawić drzwi (wyregulować zawiasy)</p> <p>(CZ) <b>Vyrovnejte dvířka</b> (seřid'te závěsy)</p> <p>(RO) Nastavenie dveri (nastavenie závesov)</p> <p>(HU) <b>Állítsa be az ajtókat</b> (állítsa be a zsanérokat)</p> <p>(SK) Reglare uši (ajustare balamale)</p> <p>(TR) <b>Kapıların ayarlanması</b> (menteşelerin seviye ayarı)</p> <p>(RU) Регулировка дверей (регулировка шарнира)</p>	

7

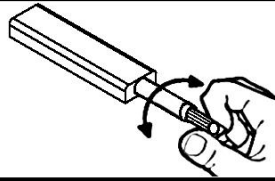

(D) Push-To-Open einstellen

(CZ) Vyrovnajte Push-To-Open

(GB) Adjusting the Push-To-Open

(RO) Nastavenie Push-To-Open

(FR) Régler les Push-To-Open

(HU) Állítsa be az Push-To-Open

(IT) Sistemare Push-To-Open

(SK) Reglare Push-To-Open

(NL) Push-To-Open instellen

(TR) Push-To-Open ayarlanması

(PL) Nastawić Push-To-Open

(RU) Регулировка Push-To-Open

1.

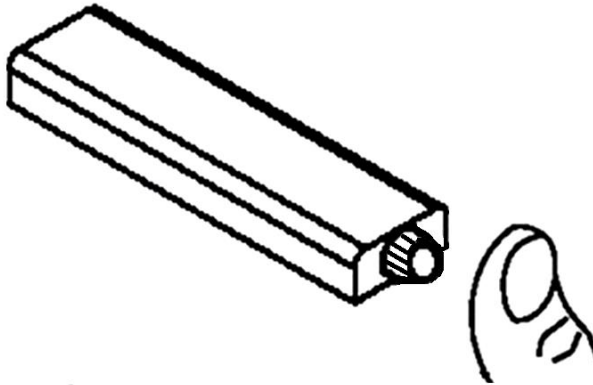

2.

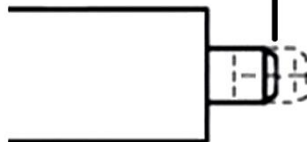
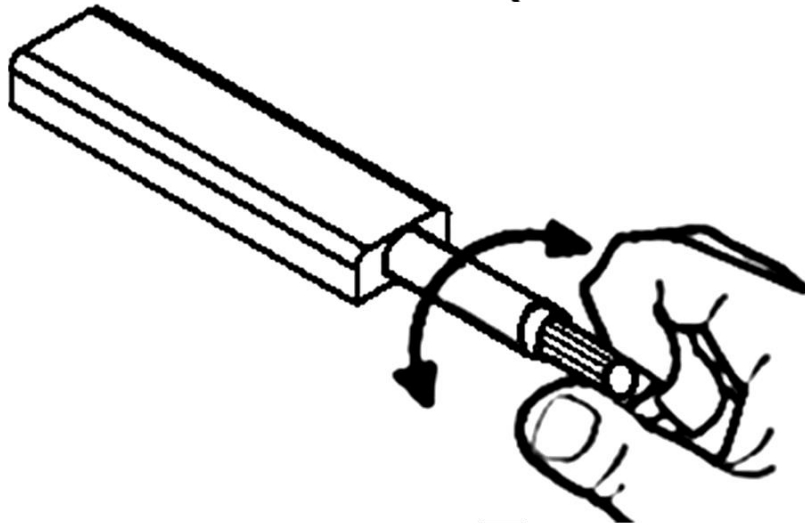



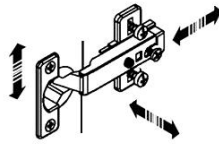

(D) Türen einstellen  
(Scharniere justieren)

(GB) Adjusting the doors  
(adjusting the hinges)

(FR) Régler les portes  
(ajuster les charnières)

(IT) Sistemare le porte  
(regolare le cerniere)

(NL) Deuren instellen  
(scharnieren afstellen)

(PL) Nastawić drzwi  
(wyregulować zawiasy)

(CZ) Vyrovnajte dvířka  
(seřid'te závěsy)

(RO) Nastavenie dverí  
(nastavenie závesov)

(HU) Állítsa be az ajtókat  
(állítsa be a zsanérokat)

(SK) Reglare uši  
(ajustare balamale)

(TR) Kapıların ayarlanması  
(menteşelerin seviye ayarı)

(RU) Регулировка дверей  
(регулировка шарнира)

