

REPC-Nr.:

Service • Assistenza • Dienstverlening • Serwis  
Servis • Szerviz • Сервисная служба

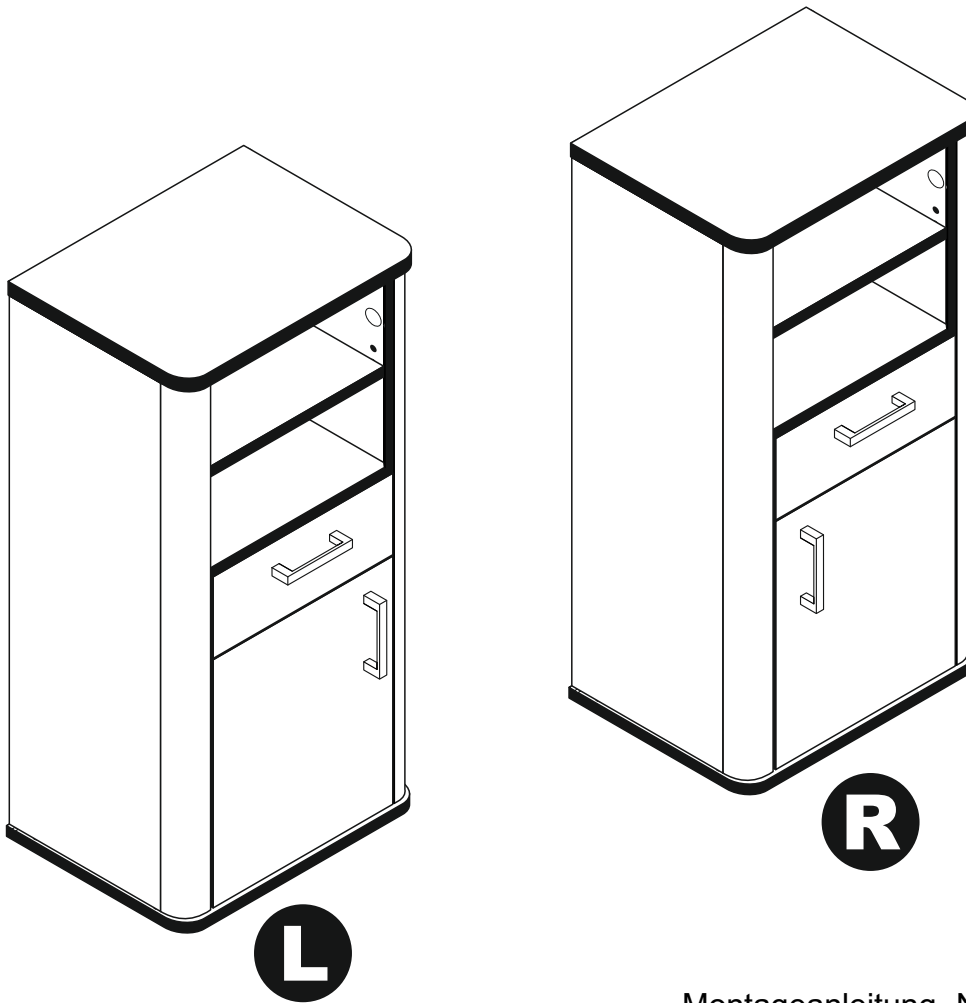

Artikel.-Nr.:

**0473\_11**

Montageanleitung.-Nr.:

**MA1-00260**

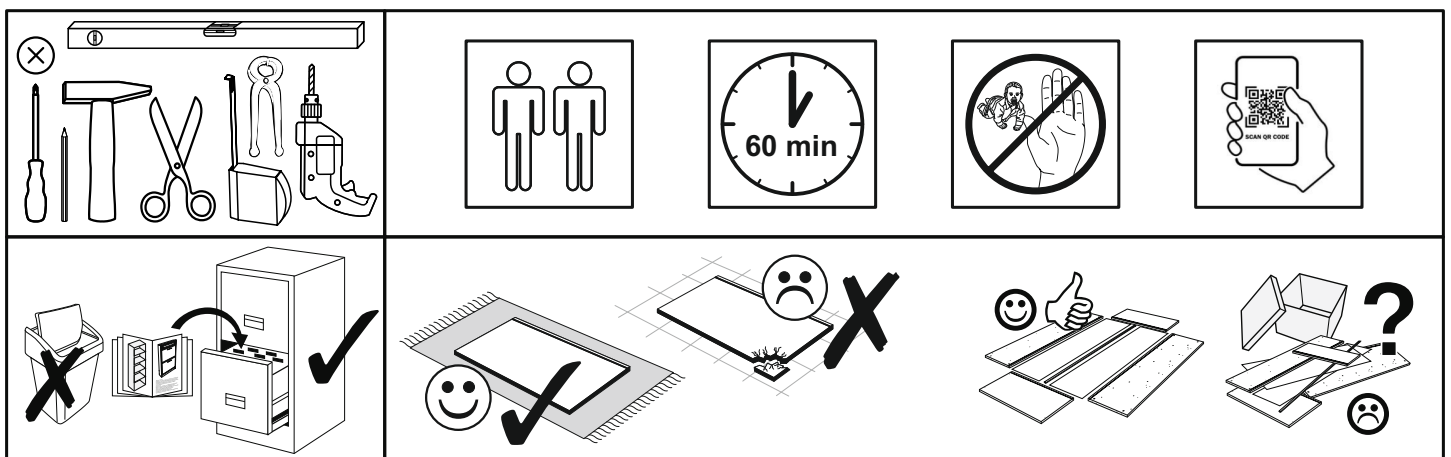

SCAN ME

Das Ersatzteil-Anforderungsformular finden Sie auf  
The replacement parts requisition form you find on  
<https://www.maeusbacher.de/ersatzteile/>

## Beutel 0473\_11 0-13 Colli 1/1

B01-10 4x 	B01-30 6x 	B01-70 2x 	B01-80 6x 	B01-90 14x 
B01-140 12x 	B01-200 4x 	B02-08 4x 	B02-10 18x 	B02-20 22x 
B02-120 1x 	B02-160 8x 			



▶ SCAN ME

## Beutel 0473\_11 0-23 Colli 1/1

B03-07 1x 	B03-25 2x 	B03-26 2x 
------------------	------------------	------------------

## Beutel 0473\_11 0-33 Colli 1/1

B05-20 6x 	B05-185 10x 	B05-190 4x 	B06-312 2x 
------------------	--------------------	-------------------	-------------------

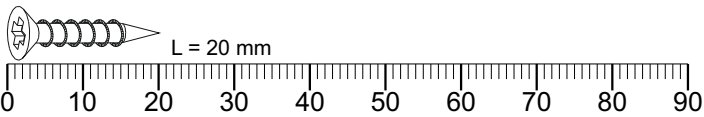

## Colli 1/1

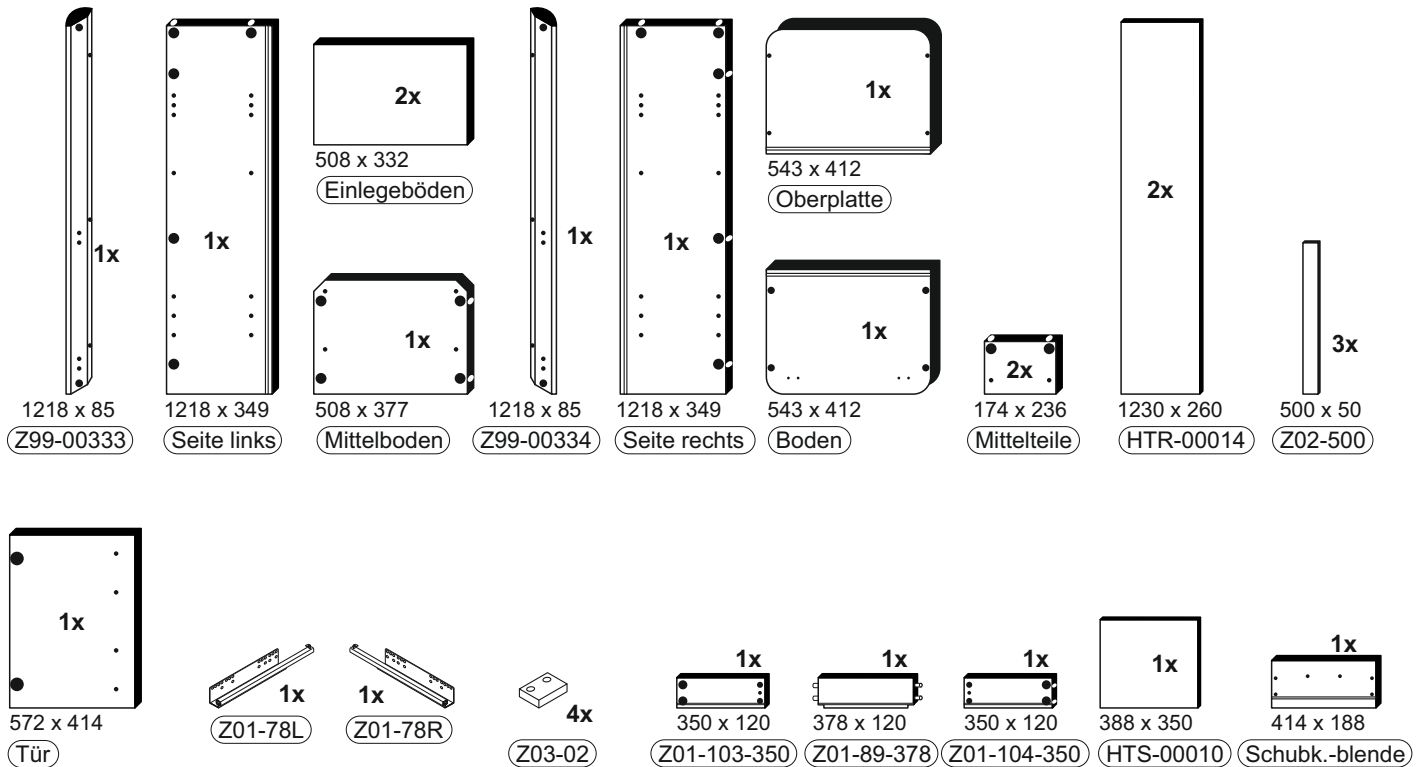

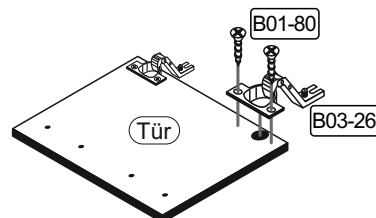
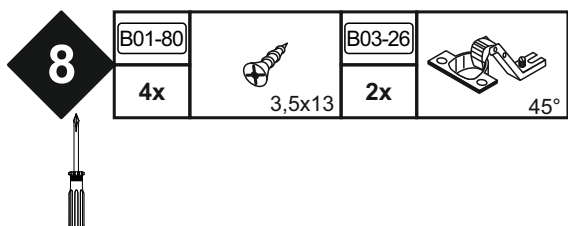
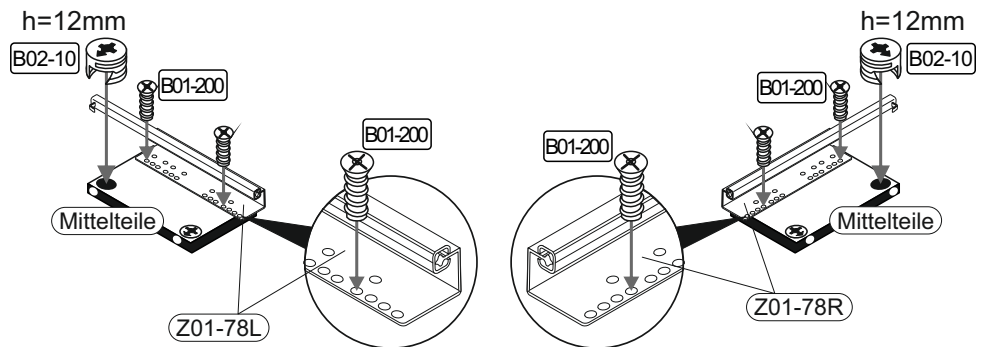
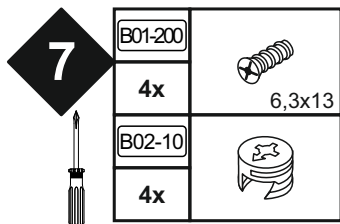
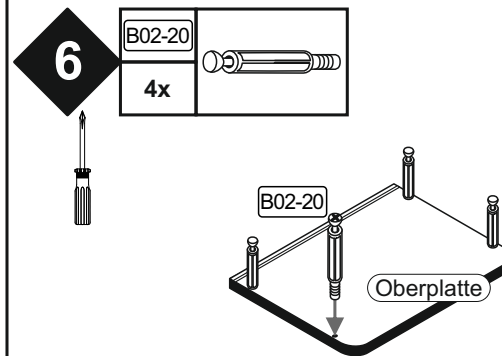
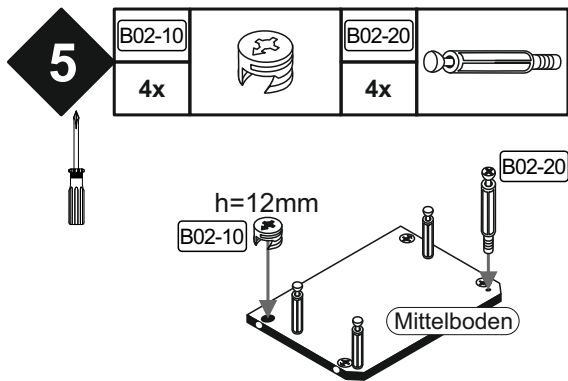
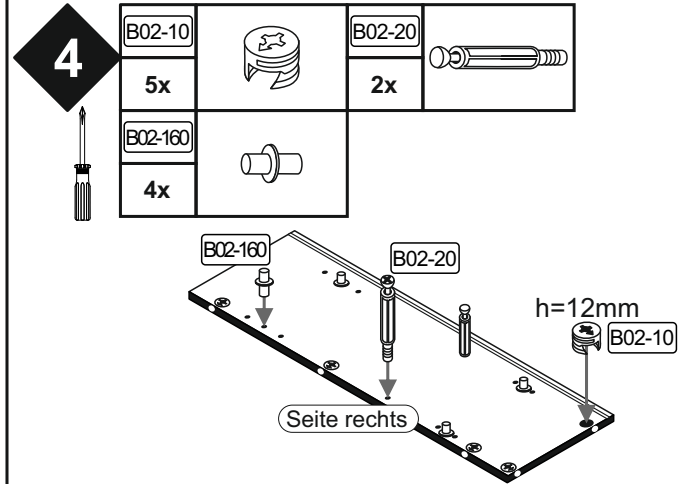
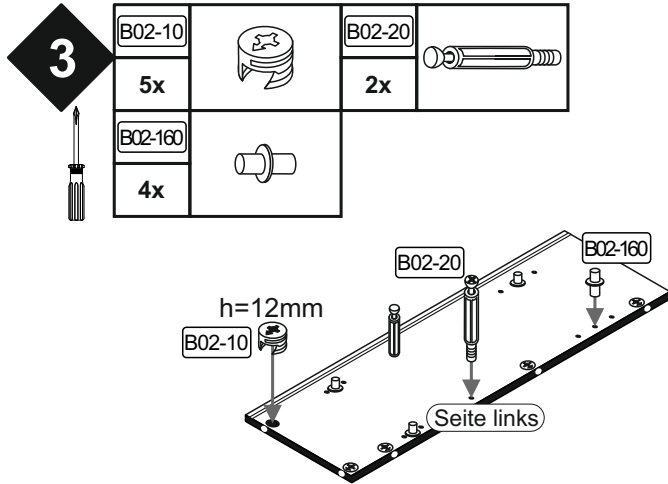
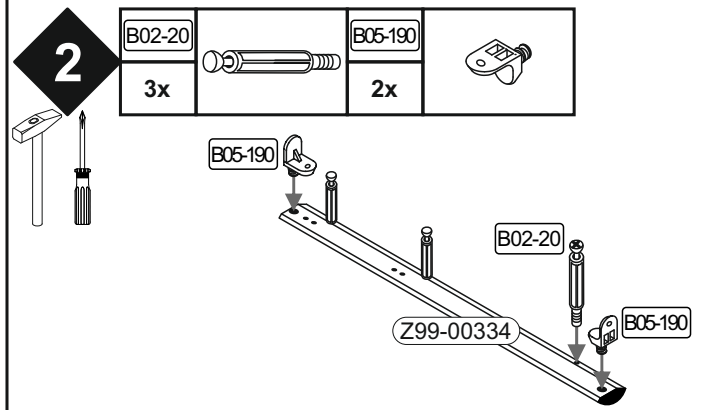
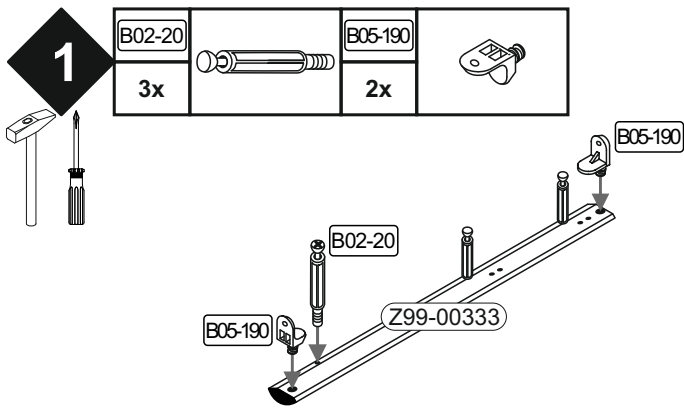

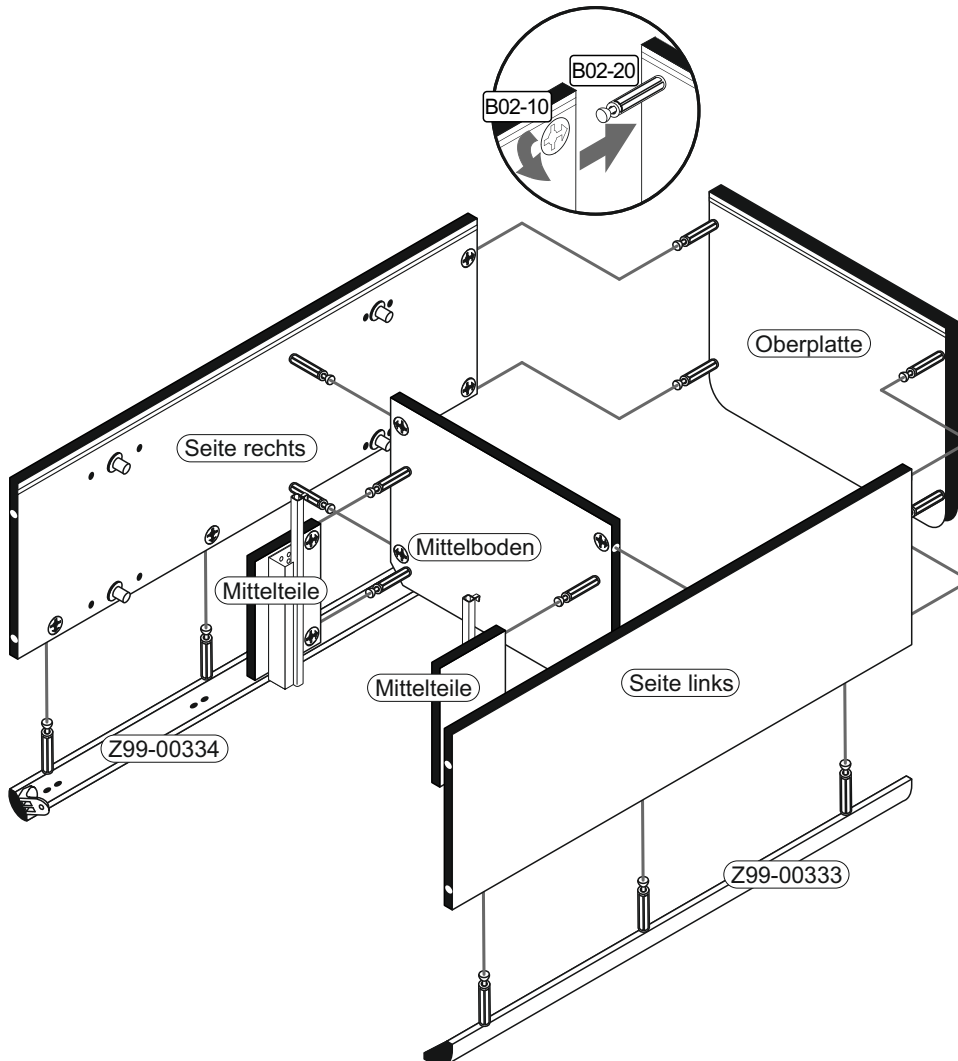
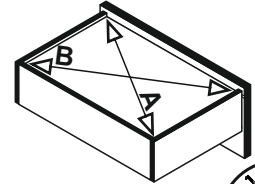
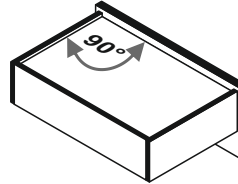
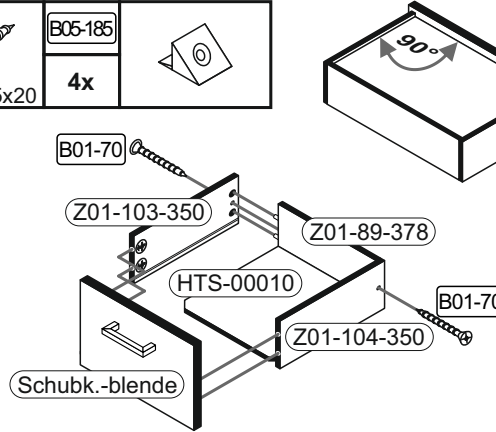
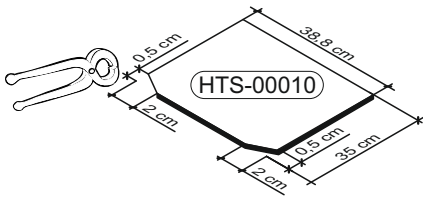
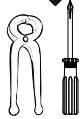
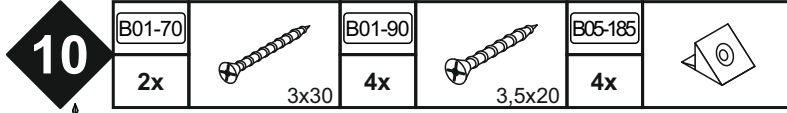
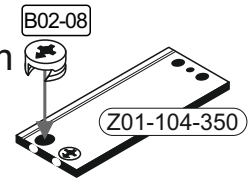
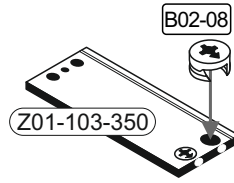
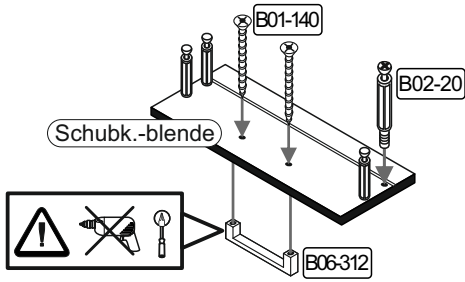
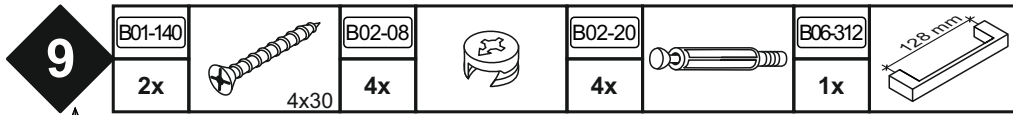

12	B01-10		B01-30		B01-90	
	4x	6,3x50	6x	3x16	6x	3,5x20
	B01-140		B05-185			
	8x	4x30	6x			

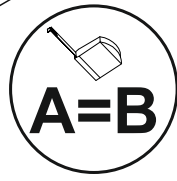
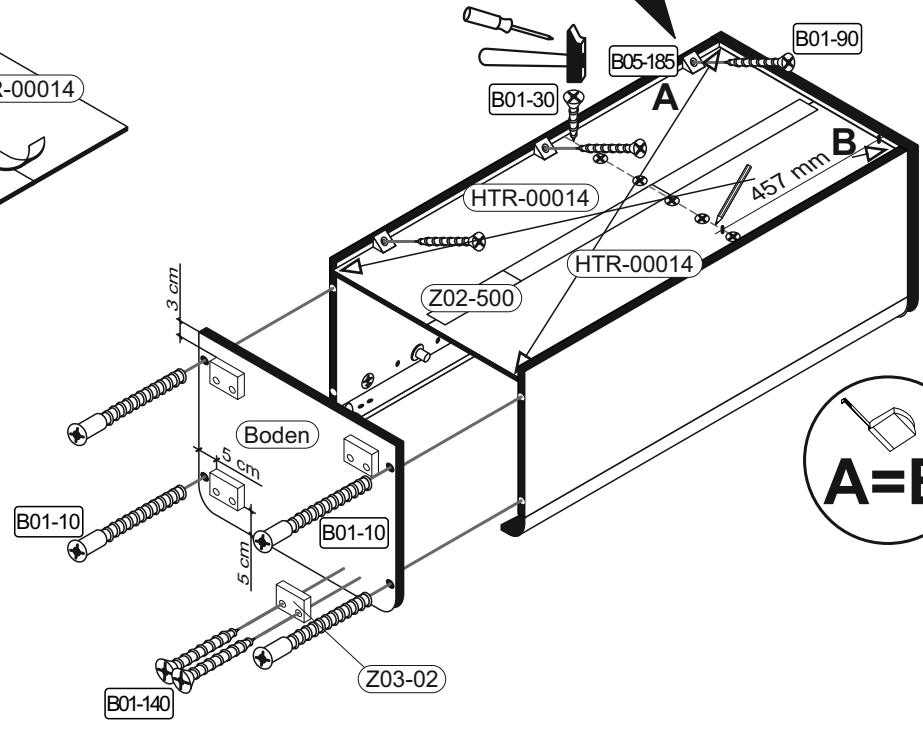
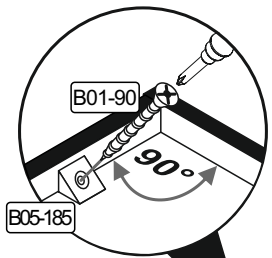
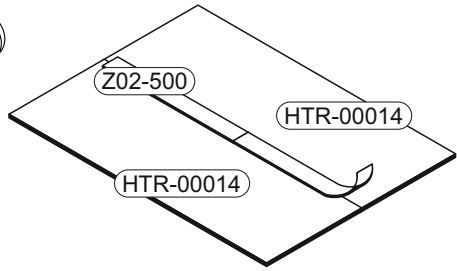
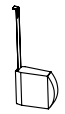



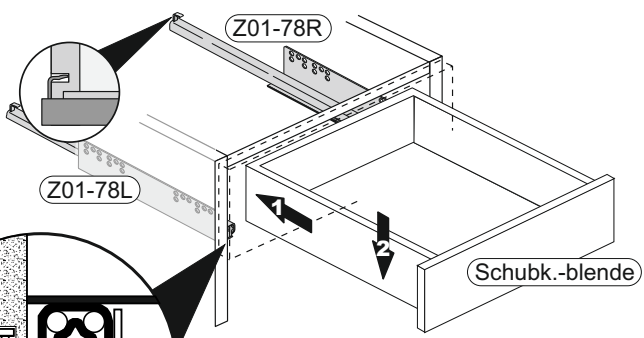
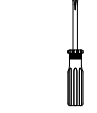

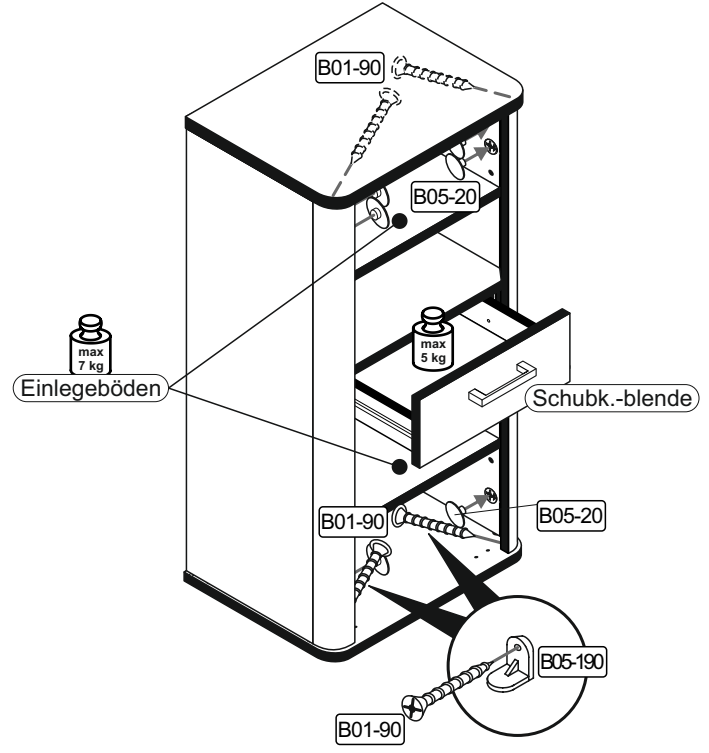

13	B01-90		B05-20	
	4x	3,5x20	6x	



Höhenverstellung des Schubkastens



14

B01-80		B01-140		B03-07		B03-25		B02-120		B06-312	
2x	3,5x13	2x	4x30	1x		2x		1x		1x	



## Montage der Türdämpfung



▶ SCAN ME

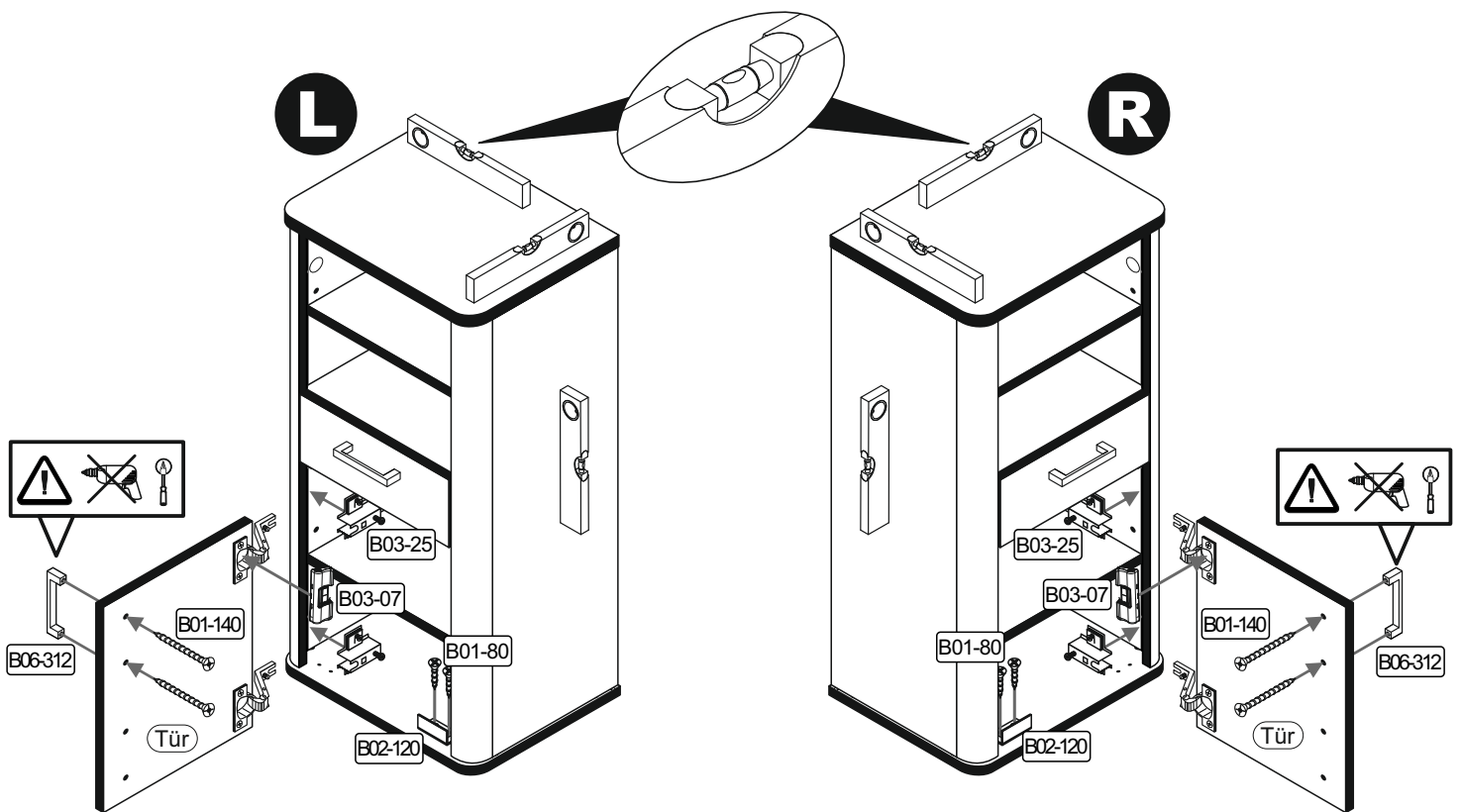
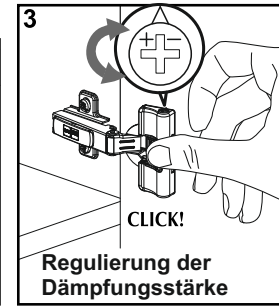
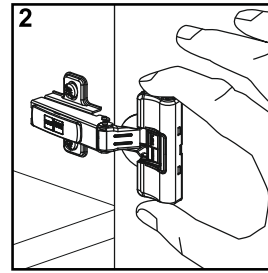
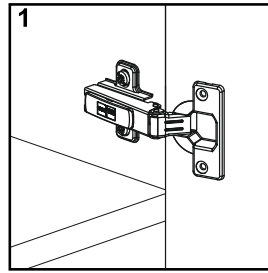

▶ SCAN ME

**Türen einstellen (Scharniere justieren)**  
 Adjusting the doors (adjusting the hinges)  
 Régler les portes (ajuster les charnières)  
 Sistemare le porte (regolare le cerniere)  
 Deuren instellen (scharnieren afstellen)  
 Nastawić drzwi (wyregulować zawiasy)  
 Vyrovnajte dvířka (seřid'te závěsy)  
 Nastavenie dverí (nastavenie závesov)  
 Állítsa be az ajtókat (állítsa be a zsanérokot)  
 Reglare ușii (ajustare balamale)  
 Kapıların ayarlanması (menteselerin seviye ayarı)  
 Регулировка дверей (регулировка шарнира)

