

## Prades

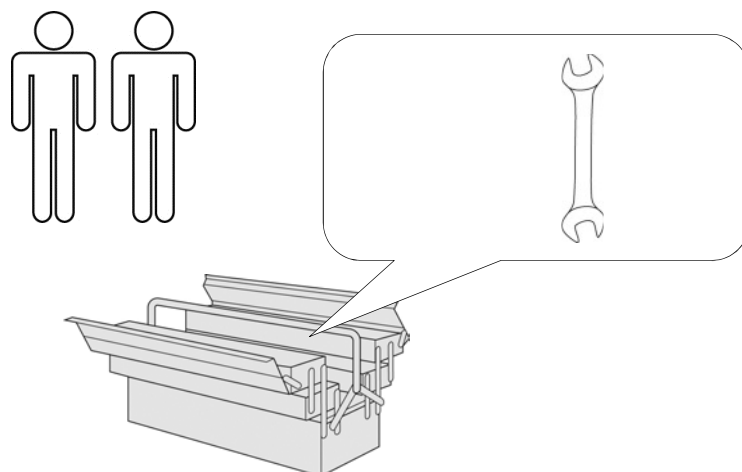





- |    |                        |    |                             |
|----|------------------------|----|-----------------------------|
| D  | Montageanleitung       | GB | Assembly instructions       |
| FR | Notice de montage      | NL | Handleiding voor de montage |
| CZ | Montážní návod         | IT | Istruzioni di montaggio     |
| RO | Instructiuni de montaj | RU | инструкция по сборке        |
| PL | Instrukcja montażu     | SK | Návod na montáž             |
| HU | Szerelési útmutató     | TR | Montaj talimati             |

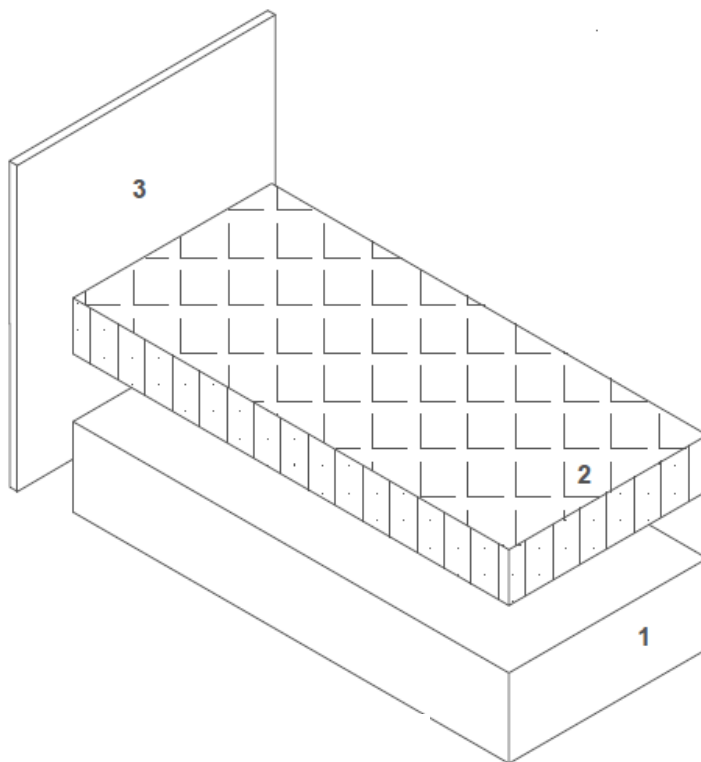

0  
10  
20  
30  
40  
50  
60  
70  
80  
90  
100  
110  
120  
130  
140  
150  
160  
170  
180  
190  
200

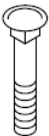
<b>Service • Assistenza • Dienstverlening • Serwis</b> <b>Servis • Szerviz • Сервисная служба</b>	
Name • Nom • Nome • Naam Nazwa • Jméno • Názov • Név Denumire • Ísim • Название	<b>Prades 140</b>
Nr. • No. • N° • Номер • Č • Sz	<b>SH50</b>
Тур • Туре • Tip • Típus • Тіро Тип	<b>BS</b>



A	B	C	D
			
4x 8x70	4x 8x40	4x M8	2x

1.

a) Bettkasten und Liegefläche positionieren



b) Liegefläche mit den Muttern am Beschlag festschrauben



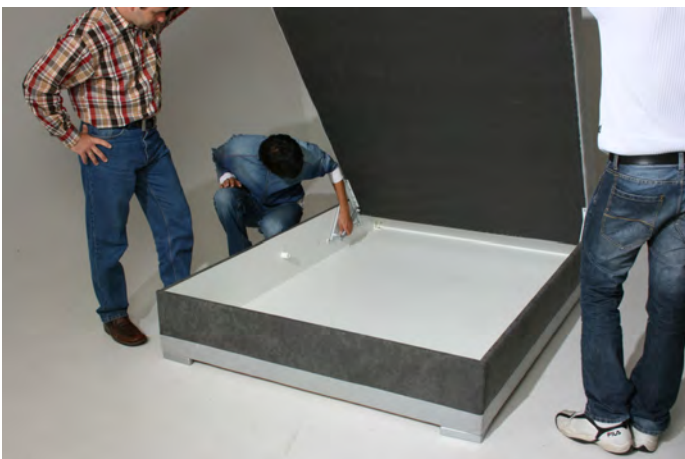

d) Bett aufstellen und Liegefläche öffnen



e) Federn auf beiden Seiten einhängen





 4x 8x70	 4x 8x40	 4x M8	<p><b>Achtung!</b> Schrauben nicht überdrehen</p> <p>FR Attention! Ne serrez pas trop</p> <p>CZ Dávej Pozor! Nepřetahujte</p> <p>RO Ai Grija! Nu strângeți</p> <p>PL Uwaga! Nie dokręcać zbyt mocno</p> <p>HU Vigyázz! Ne húzza túl</p>	<p>GB Watch Out! Do not over tighten</p> <p>NL Let Op! Niet te vast</p> <p>IT Attenzione! Non stringere</p> <p>RU Осторожно! Не затягивайте</p> <p>SK Dávaj Pozor! Nepretahujte</p> <p>TR Dikkat! Üzerinde sıkmayın</p>
------------------------------------------------------------------------------------------------	------------------------------------------------------------------------------------------------	----------------------------------------------------------------------------------------------	-----------------------------------------------------------------------------------------------------------------------------------------------------------------------------------------------------------------------------------------	-------------------------------------------------------------------------------------------------------------------------------------------------------------------------------------------------------------------------

